

DE Kurzanleitung
EN Quick Guide
FR Guide abrégé
NL Korte handleiding
IT Guida breve
DK Kort vejledning
SE Snabbguide

ZS50.99050006
15.03.2024

Digital Cylinder AX (Z5) Modularity

Simons  **Voss**
technologies

Abbildungen/Images	3
deutsch	34
english	40
français	45
nederlands	51
italiano	57
dansk	63
svensk	68



3.2 Cam

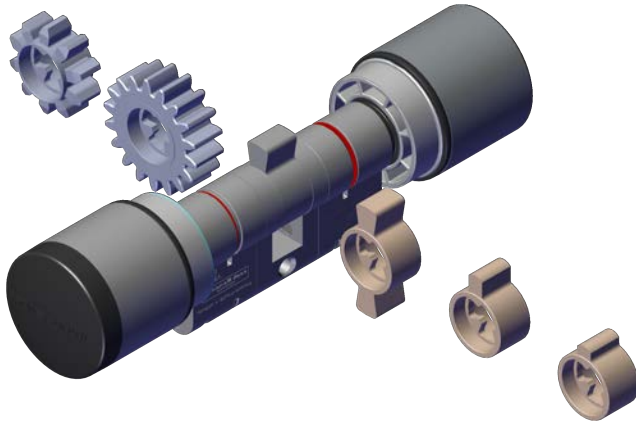

3.3 Tools

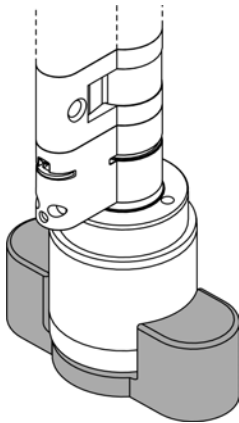
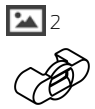

4. Extend Cylinder AX



3

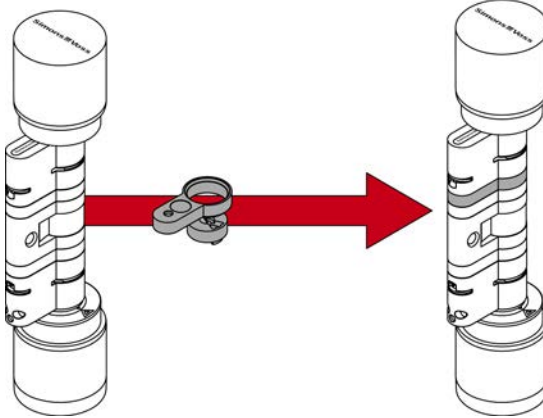

4

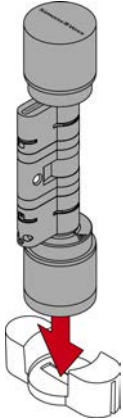

5

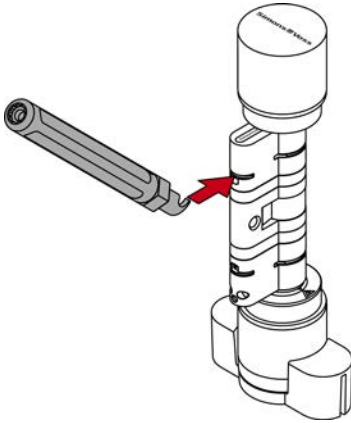

6

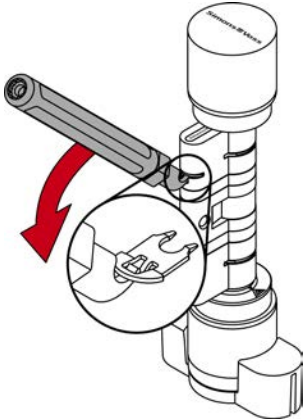

7

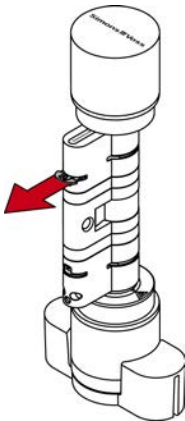

 8

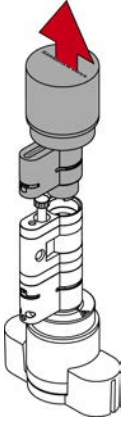

 9

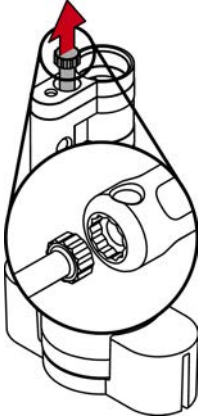

 10

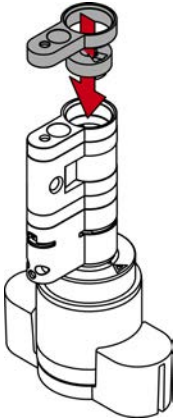

11

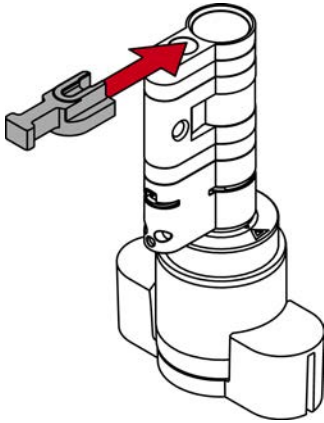

12

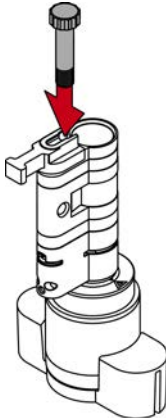

13

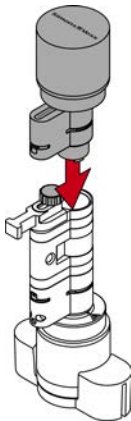

 14

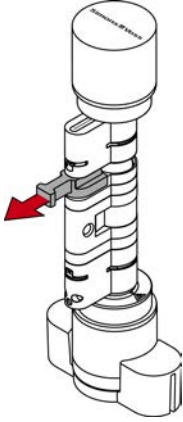

 15

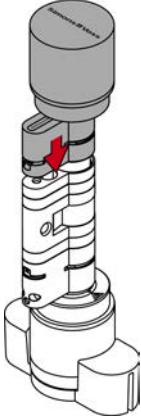

 16

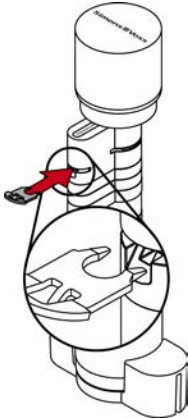

17

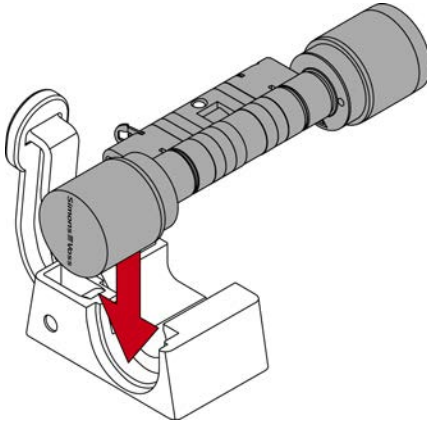

5. Shorten Cylinder AX

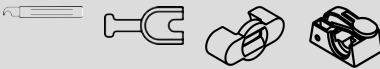

18

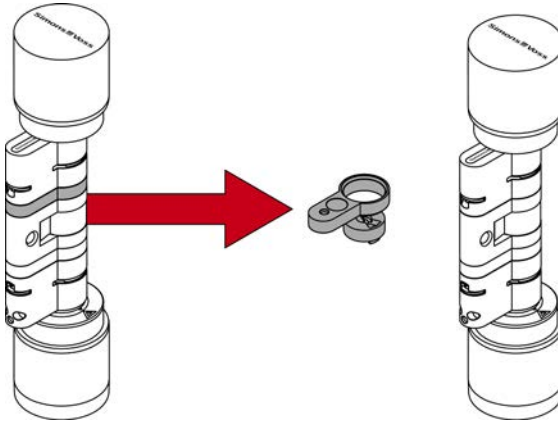

19

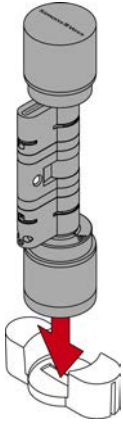

20

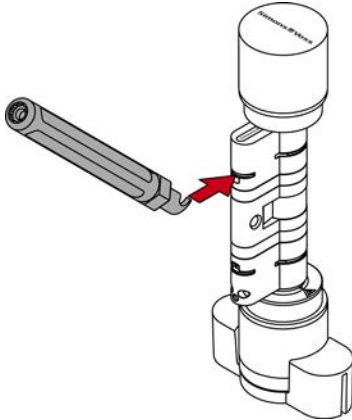

21

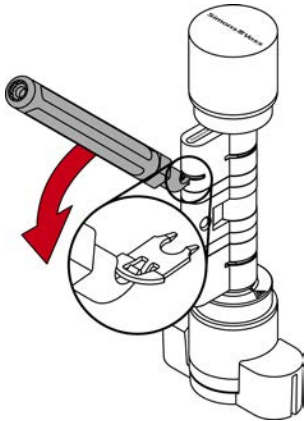

 22

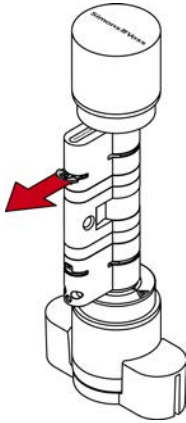

 23

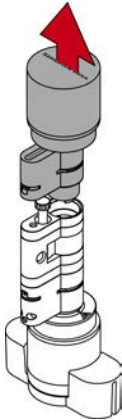

 24

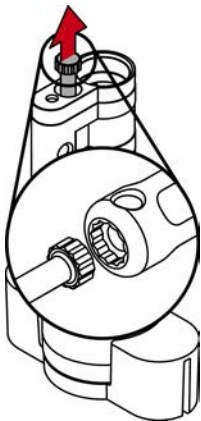

 25

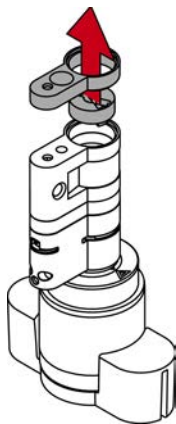

 26

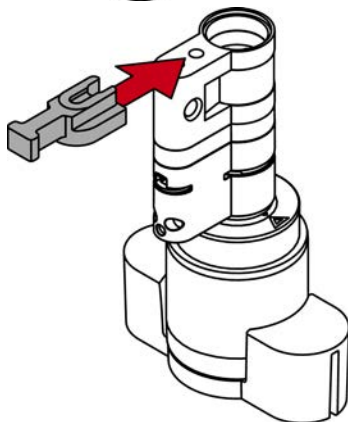

 27

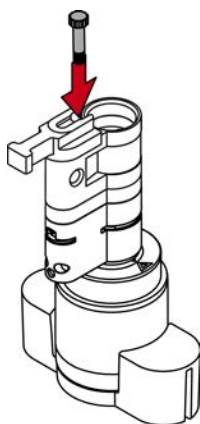

 28

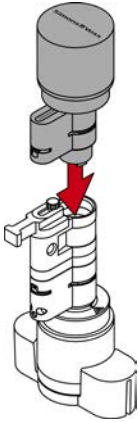

 29

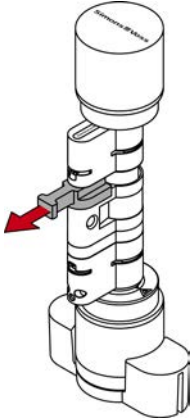

 30

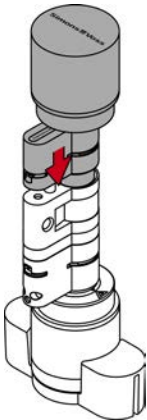

 31

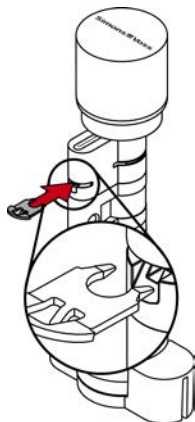

 32

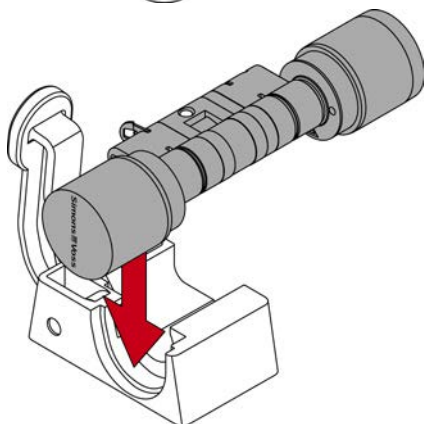

 33

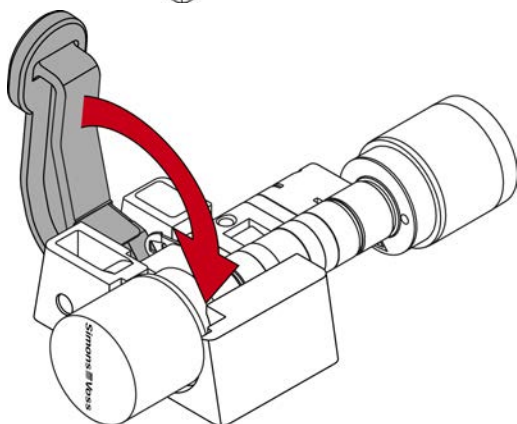

6. Combine CO cylinders to FD



34

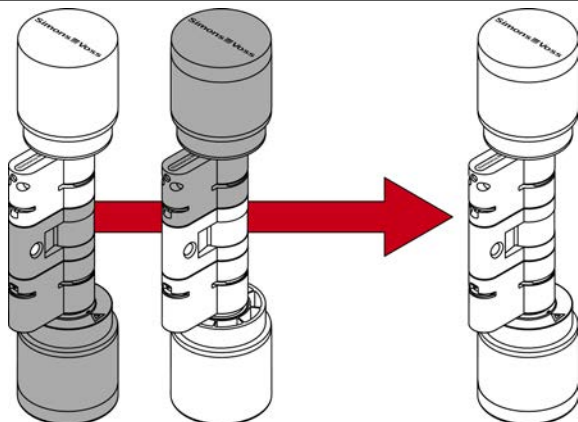

35

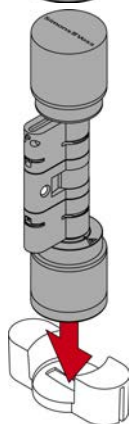

 36

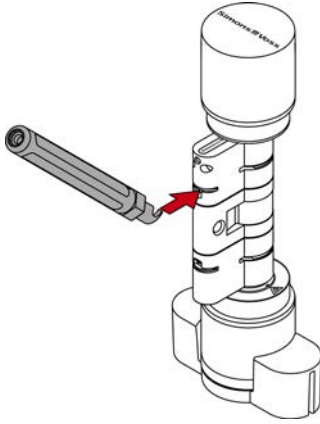

 37

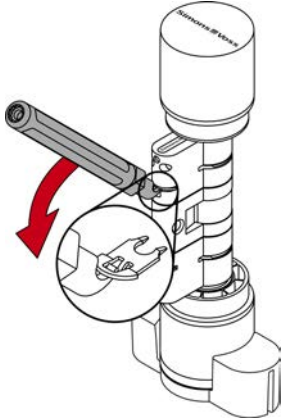

 38

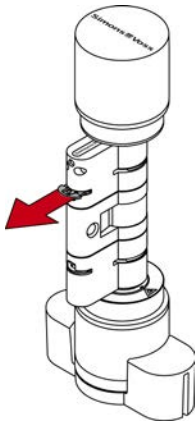

 39

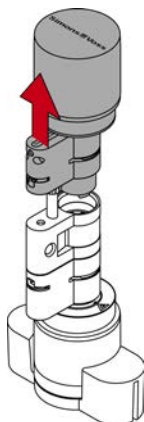

 40

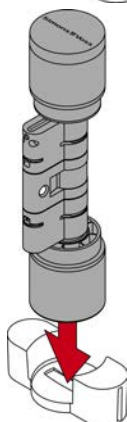

 41

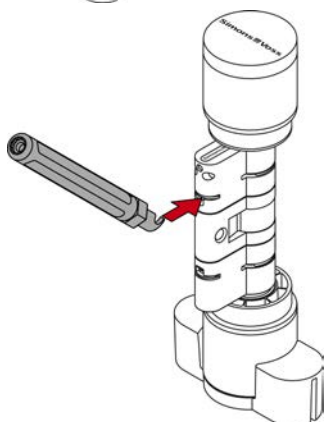

 42

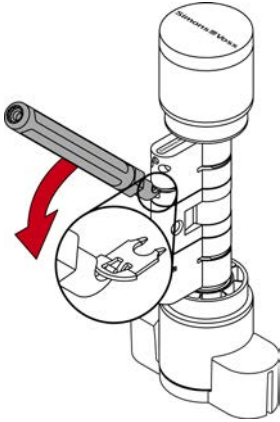

 43



 44

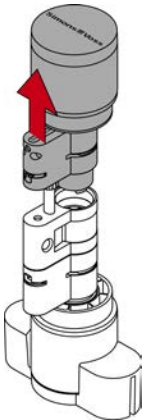

 45

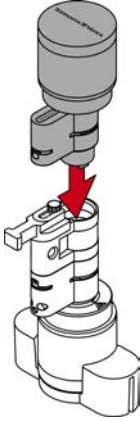

 46

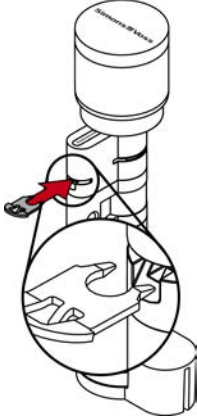

 47

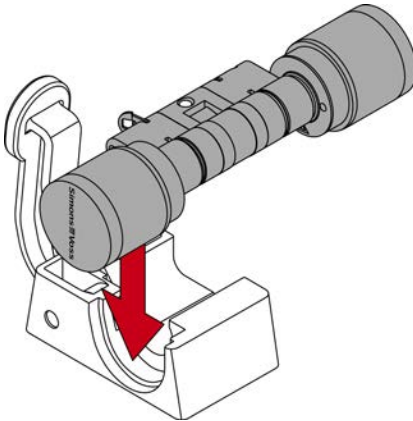

48

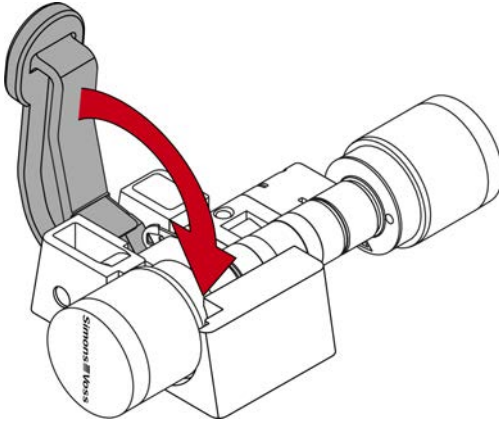

7. Reduce CO cylinders to HZ



49

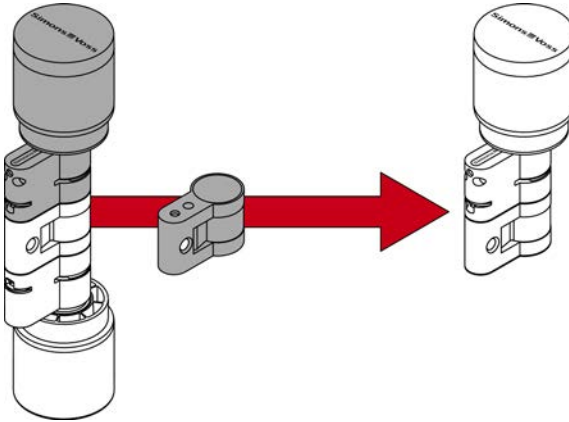

50

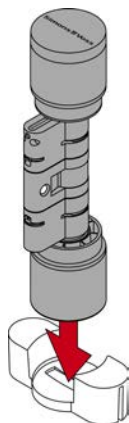

51

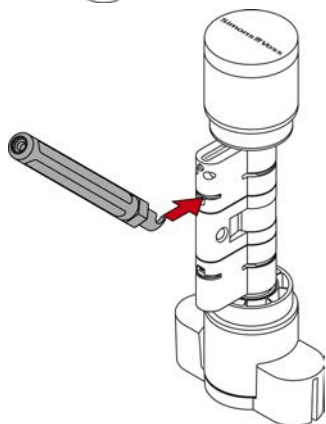

52

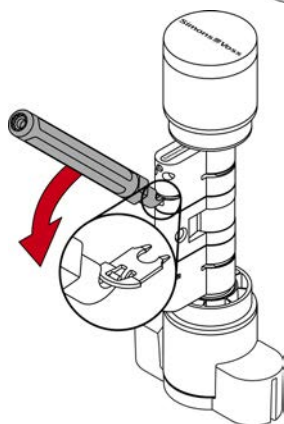

 53

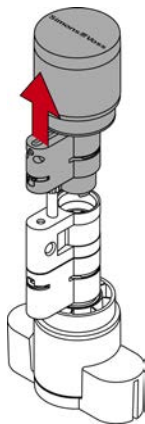

 54

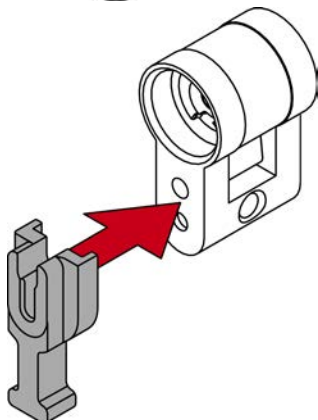

 55

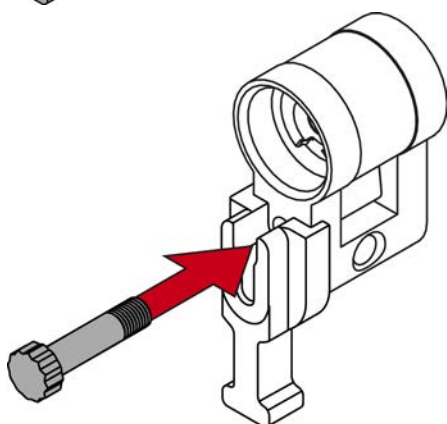

56

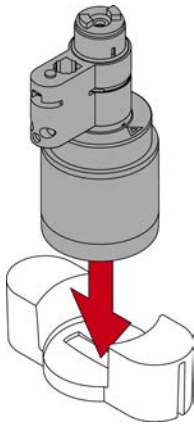

57

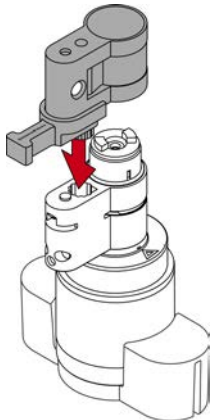

58

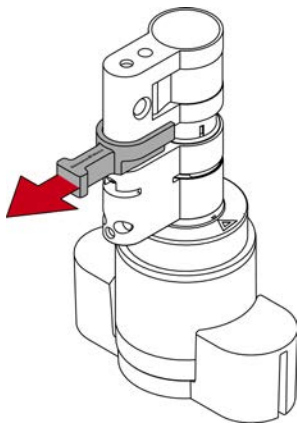

 59

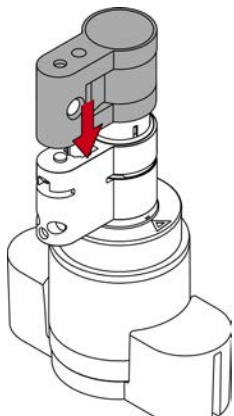

 60

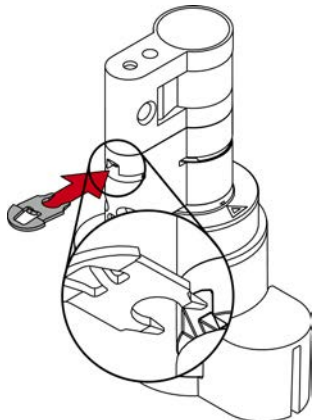

 61

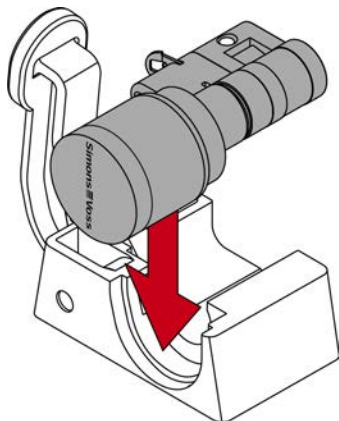

62

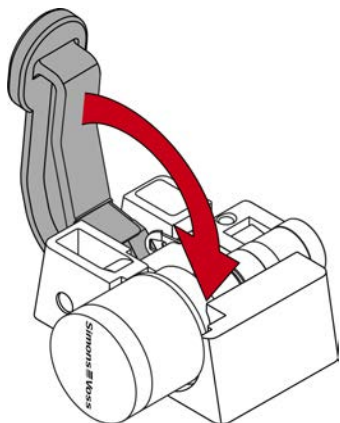

8. Replacing the cam



63

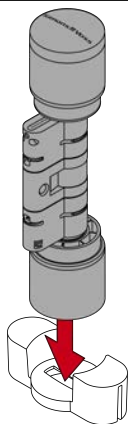

 64

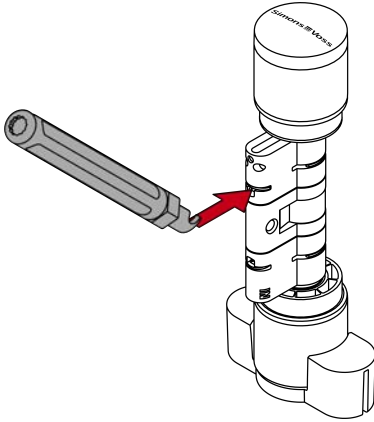

 65

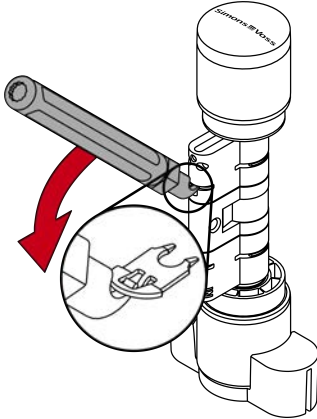

 66

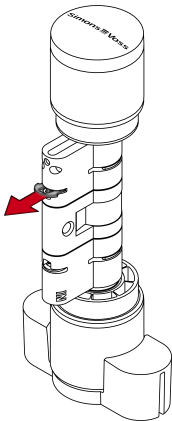

 67

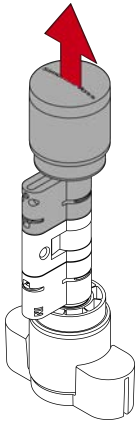

 68

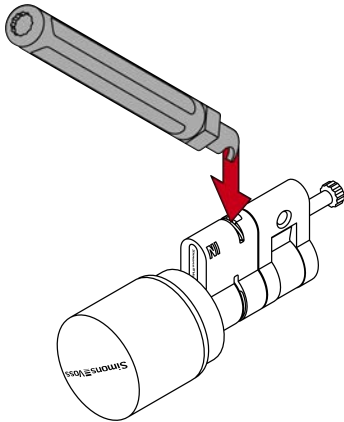

 69

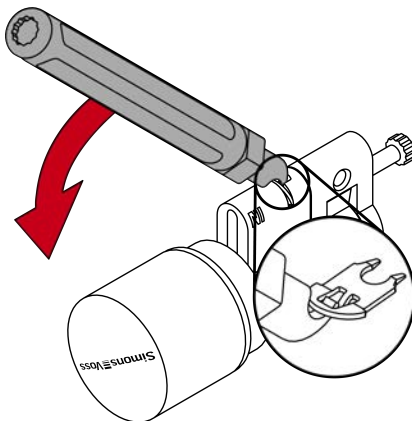

 70

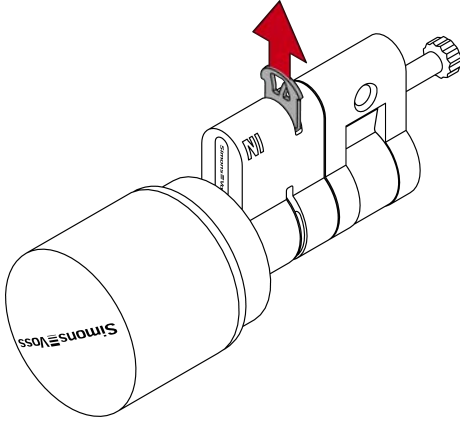

 71

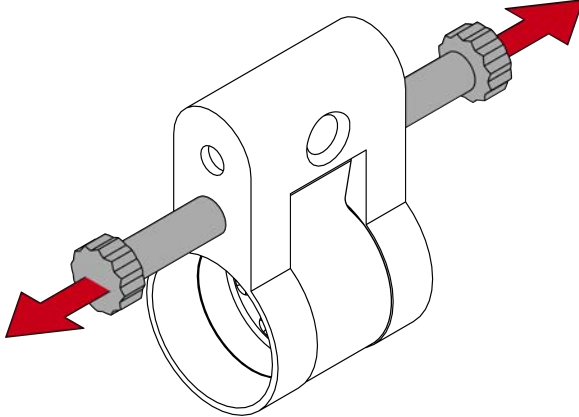

 72

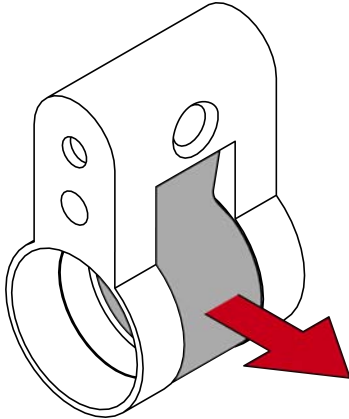

 73

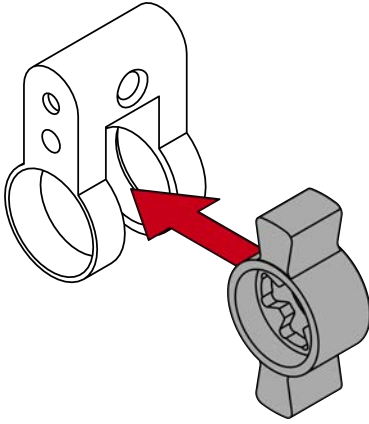

 74

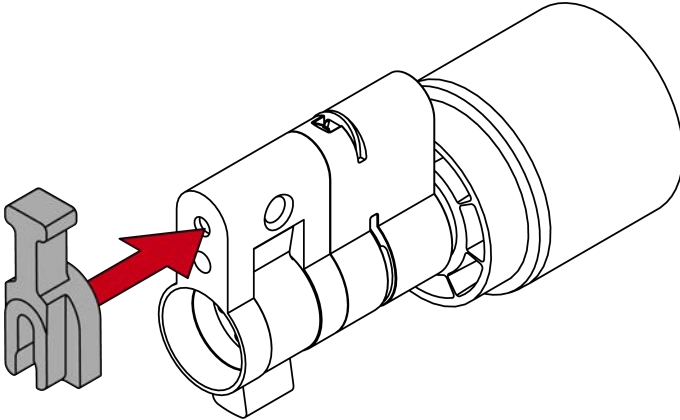

 75

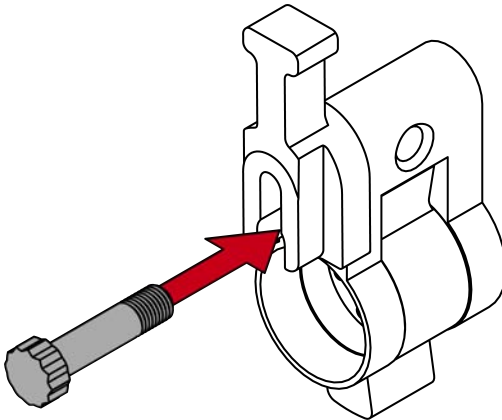

 76

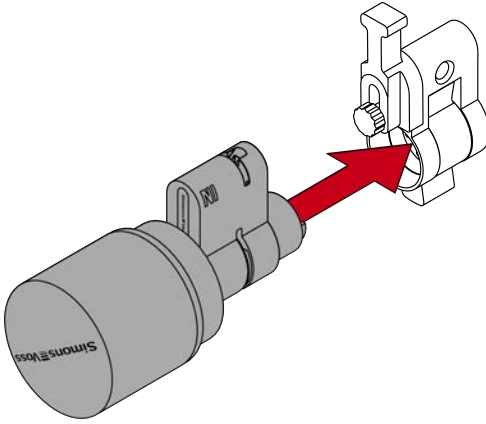

 77

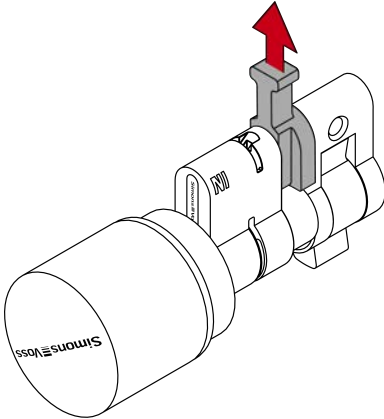

 78

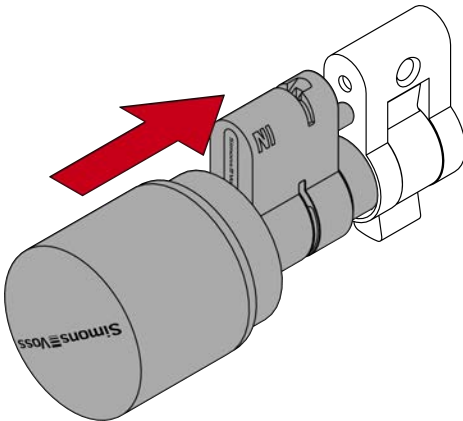

79

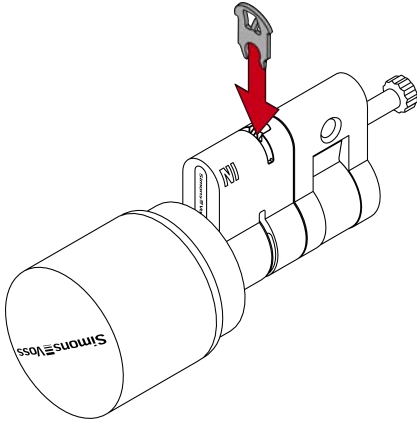

74

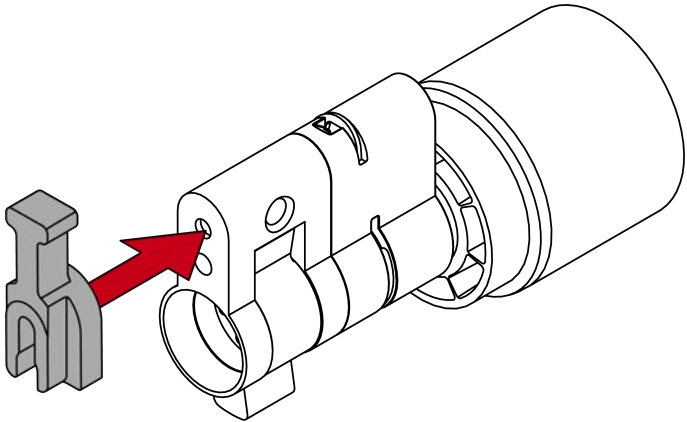

81

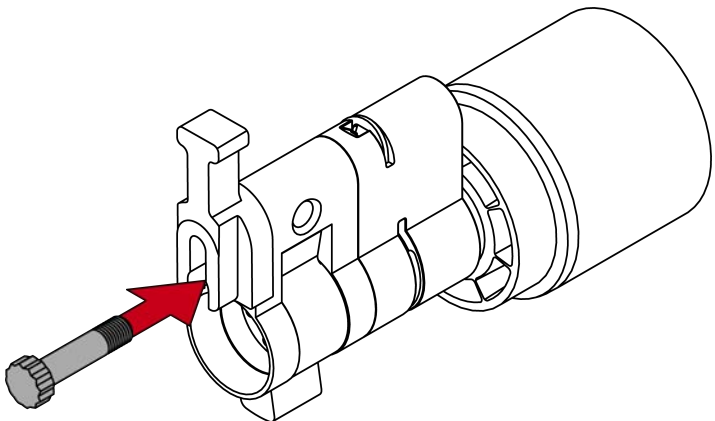

 82

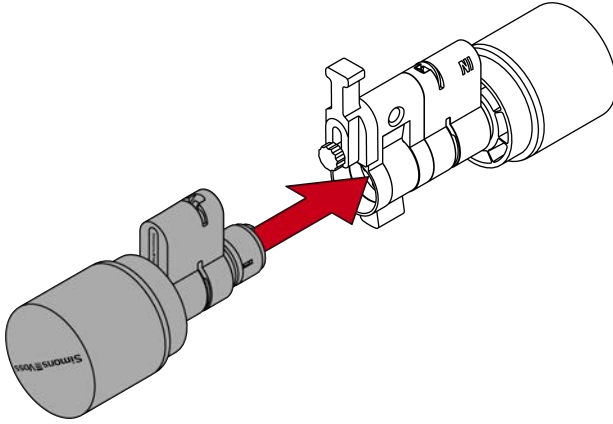

 83

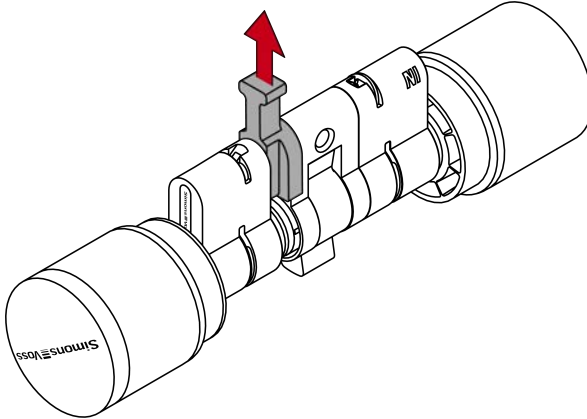

 84

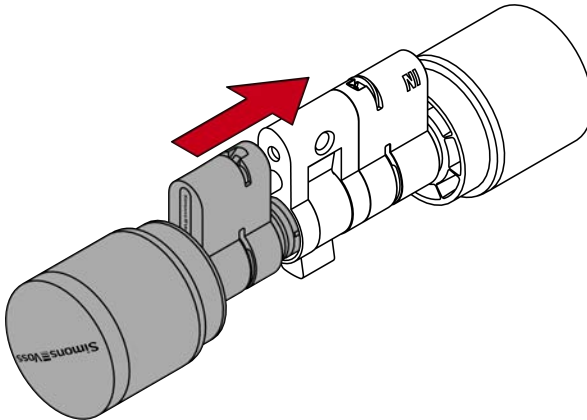

85

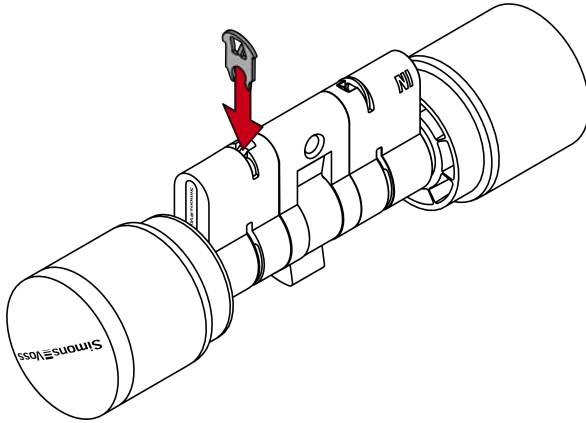

86

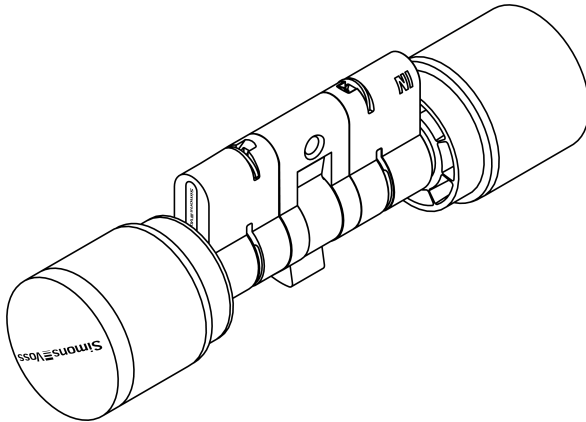

Inhaltsverzeichnis

1.	Allgemeine Sicherheitshinweise.....	35
2.	Produktspezifische Sicherheitshinweise	35
3.	Zubehör und Werkzeuge	35
3.1	Längenmodularität	35
3.2	Mitnehmer	36
3.3	Werkzeuge	36
4.	Cylinder AX verlängern.....	36
5.	Cylinder AX verkürzen	36
6.	CO-Zylinder zu FD kombinieren	37
7.	CO-Zylinder zu HZ reduzieren.....	37
8.	Mitnehmer austauschen	38
9.	Hilfe und weitere Informationen.....	39

1. Allgemeine Sicherheitshinweise

Signalwort: Mögliche unmittelbare Auswirkungen bei Nichtbeachtung
WARNUNG: Tod oder schwere Verletzung (möglich, aber unwahrscheinlich)
ACHTUNG: Sachschäden oder Fehlfunktionen, **HINWEIS:** Geringe oder keine



WARNUNG

Versperrter Zugang

Durch fehlerhaft montierte und/oder programmierte Komponenten kann der Zutritt durch eine Tür versperrt bleiben. Für Folgen eines versperrten Zutritts wie Zugang zu verletzten oder gefährdeten Personen, Sachschäden oder anderen Schäden haftet die SimonsVoss Technologies GmbH nicht!

Versperrter Zugang durch Manipulation des Produkts

Wenn Sie das Produkt eigenmächtig verändern, dann können Fehlfunktionen auftreten und der Zugang durch eine Tür versperrt werden.

- Verändern Sie das Produkt nur bei Bedarf und nur in der Dokumentation beschriebenen Art und Weise.

ACHTUNG

Beschädigung durch Öle, Fette, Farben und Säuren

Dieses Produkt enthält elektronische und/oder mechanische Bauteile, die durch Flüssigkeiten aller Art beschädigt werden können.

- Halten Sie Öle, Fette, Farben und Säuren vom Produkt fern.

Beschädigung durch aggressive Reinigungsmittel

Die Oberfläche dieses Produkts kann durch ungeeignete Reinigungsmittel beschädigt werden.

- Verwenden Sie ausschließlich Reinigungsmittel, die für Kunststoff- bzw. Metalloberflächen geeignet sind.



HINWEIS

Bestimmungsgemäßer Gebrauch

SimonsVoss-Produkte sind ausschließlich für das Öffnen und Schließen von Türen und vergleichbaren Gegenständen bestimmt.

- Verwenden Sie SimonsVoss-Produkte nicht für andere Zwecke.

Qualifikationen erforderlich

Die Installation und Inbetriebnahme setzt Fachkenntnisse voraus.

- Nur geschultes Fachpersonal darf das Produkt installieren und in Betrieb nehmen.

Änderungen bzw. technische Weiterentwicklungen können nicht ausgeschrieben und ohne Ankündigung umgesetzt werden.

Die deutsche Sprachfassung ist die Originalbetriebsanleitung. Andere Sprachen (Abfassung in der Vertragssprache) sind Übersetzungen der Originalbetriebsanleitung.

Lesen Sie alle Anweisungen zur Installation, zum Einbau und zur Inbetriebnahme und befolgen Sie diese. Geben Sie diese Anweisungen und jegliche Anweisungen zur Wartung an den Benutzer weiter.

2. Produktspezifische Sicherheitshinweise



WARNUNG

Störung der Antipanikfunktion durch unzulässige Manipulation

Der Digital Cylinder AX hat in der Antipanik-Variante ein Antipanik-Modul fest eingebaut und ist eingeschränkt längenmodular: Außenseite beliebig, Innenseite ab 50 mm und Halbzylinder ab 50 mm.

- Versuchen Sie nicht, das Antipanik-Modul zu demontieren, da dieses sonst beschädigt werden kann.
- Führen Sie nach jedem Umbau einen Antipanik-Funktionstest durch.

3. Zubehör und Werkzeuge

3.1 Längenmodularität

Der Profilylinder kann mit folgenden Teilen verlängert und verkürzt werden:

Verlängerungsbolzen	Kernverlängerung des Profils	Profilverlängerung
		
<ul style="list-style-type: none"> Z5.BOLT.XX (XX=Gewünschte Grundlänge) 	<ul style="list-style-type: none"> Z5.CORE.05: 5 mm Z5.CORE.10: 10 mm Z5.CORE.20: 20 mm 	<ul style="list-style-type: none"> Z5.PROFILE.05: 5 mm Z5.PROFILE.10: 10 mm Z5.PROFILE.20: 20 mm

Klammer



- Z5.CLAMPS

Ein Set enthält 50 Stück.

Zylinder-Mittelstück



- Z5.CNT.EU

Halbzylinder-Mittelstück



- Z5.CNT.HZ

Halbzylinder-Mittelstück mit Multitrast



- Z5.CNT.HZ.MR

Knaufaufnahme innen



- Z5.PR.IN

Blindprofil innen ohne Knauf



- Für Variante .OK
- Z5.PR.OK







Knaufaufnahme für Glastürknauf

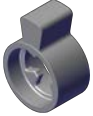

- Profillänge 30 mm (verlängerbar)
- Z5.PR.GD

3.2 Mitnehmer

Zusätzlich haben Sie die Auswahl zwischen verschiedenen Mitnehmern:

Mitnehmer Standard	Mitnehmer PM1 (lang)	Mitnehmer PM2 (kurz)
 Z5.CAM.WP	 Z5.CAM.PM1	 Z5.CAM.PM2
Doppelmitnehmer	Mitnehmer Zahnrad 10 Zähne	Mitnehmer Zahnrad 18 Zähne
 Z5.CAM.DOUBLE	 Z5.CAM.GEAR10	 Z5.GEAR.18

3.3 Werkzeuge

Zur Anpassung des Digital Cylinder AX stehen verschiedene Werkzeuge zur Verfügung:

Ausheber (Z5.LIFTER)	Abstandshalter (Z5.SPACER)	Klemmblock (Z5.BLOCK)
		

Das Knauf-Montagewerkzeug des Digital Cylinder AX ist so konstruiert, dass Sie es als Halterung für den Digital Cylinder AX verwenden können. Legen Sie es mit der flachen Seite auf eine ebene Fläche und stellen Sie den Digital Cylinder AX mit dem Knauf in das Montagewerkzeug. Das Wieder-Zusammensetzen ist einfacher, wenn der Digital Cylinder AX in der Halterung steht.



4. Cylinder AX verlängern



Die Kernverlängerung und die Profilverlängerung müssen gleich lang sein. Zusätzlich benötigen Sie einen Verlängerungsbolzen für die gewünschte Länge.

- ✓ Ausheber zum Lösen der Klammer
- ✓ Abstandshalter zum Ausrichten des Verlängerungsbolzens
- ✓ Klemmblock zum Einpressen der Klammer

1. Stellen Sie den Cylinder AX in das Knauf-Montagewerkzeug.



2. Haken Sie die Spitze des Aushebers in die Klammer ein.



3. Hebeln Sie die Klammer aus dem Profilylinder, indem Sie den Ausheber in die Mitte des Zylinders bewegen.



4. Ziehen Sie die Klammer vollständig aus dem Profilylinder.



5. Nehmen Sie die beiden Zylinderhälften auseinander.



6. Schrauben Sie mit dem Ausheber den Verlängerungsbolzen heraus.



7. Setzen Sie passende Kernverlängerungen ein.



8. Stecken Sie passende Profilverlängerungen auf.



9. Legen Sie den Abstandshalter an.



10. Schrauben Sie mit dem Ausheber einen passenden Verlängerungsbolzen ein, bis er am Abstandshalter anliegt.



HINWEIS

Länge auf Bolzenkopf

Sie finden auf dem Bolzenkopf eine Zahl. Diese Zahl ist die Länge des Zylinderprofils, zu dem der Bolzen passt.



11. Setzen Sie die beiden Zylinderhälften wieder zusammen.



↳ Verlängerungsbolzen ist gegen Verdrehen geschützt.

12. Ziehen Sie den Abstandshalter wieder ab.



13. Schieben Sie die Hälften vollständig zusammen.



14. Setzen Sie die Klammer mit der Nase zur Stulpschraube wieder in den Schlitz des Profilylinders ein und drücken Sie die Klammer mit dem Daumen fest, damit sie nicht mehr herausfallen kann.



15. Setzen Sie den Zylinder in den Klemmblock ein, sodass der Profilylinder und der Knauf bündig in den Aussparungen liegen.



↳ Der Hebel des Klemmblocks ist an einer Stelle mit einem Metallplättchen verstärkt. Die vorhin eingeschobene Klammer liegt gegenüber dieses Metallplättchens.

16. Drücken Sie den Hebel des Klemmblocks zur Bodenplatte, bis die Klammer wieder vollständig im Profilylinder sitzt.



↳ Cylinder AX ist verlängert.

5. Cylinder AX verkürzen



Sie benötigen einen Bolzen für die gewünschte Länge.

- ✓ Ausheber zum Lösen der Klammer
- ✓ Abstandshalter zum Ausrichten des Bolzens
- ✓ Klemmblock zum Einpressen der Klammer

1. Stellen Sie den Cylinder AX in das Knauf-Montagewerkzeug.



2. Haken Sie die Spitze des Aushebers in die Klammer ein.



3. Hebeln Sie die Klammer aus dem Profilylinder, indem Sie den Ausheber in die Mitte des Zylinders bewegen.



4. Ziehen Sie die Klammer vollständig aus dem Profilylinder.





5. Nehmen Sie die beiden Zylinderhälften auseinander.



6. Schrauben Sie mit dem Ausheber den Bolzen heraus.









- Nehmen Sie die Profilverlängerungen ab.
- Nehmen Sie die Kernverlängerungen ab.
  25
- Legen Sie den Abstandshalter an.
  26
- Schrauben Sie mit dem Ausheber einen passenden Bolzen ein, bis er am Abstandshalter anliegt.



HINWEIS

Länge auf Bolzenkopf















Sie finden auf dem Bolzenkopf eine Zahl. Diese Zahl ist die Länge des Zylinderprofils, zu dem der Bolzen passt.

-  27
 - Setzen Sie die beiden Zylinderhälften wieder zusammen.
  28
 - ↳ Bolzen ist gegen Verdrehen geschützt.
 - Ziehen Sie den Abstandshalter wieder ab.
  29
 - Schieben Sie die Hälften vollständig zusammen.
  30
 - Setzen Sie die Klammer mit der Nase zur Stulpschraube wieder in den Schlitz des Profilzylinders ein.
  31
 - Setzen Sie den Zylinder in den Klemmblock ein, sodass der Profilzylinder und der Knauf bündig in den Aussparungen liegen.
  32
 - ↳ Der Hebel des Klemmblocks ist an einer Stelle mit einem Metallplättchen verstärkt. Die vorhin eingeschobene Klammer liegt gegenüber dieses Metallplättchens.
 - Drücken Sie den Hebel des Klemmblocks zur Bodenplatte, bis die Klammer wieder vollständig im Profilzylinder sitzt.
  33
 - ↳ Cylinder AX ist verkürzt.

6. CO-Zylinder zu FD kombinieren











Aus zwei AX-Comfortzylindern können Sie einen freidrehenden Cylinder AX zusammensetzen.





- ✓ Ausheber zum Lösen der Klammer
 - ✓ Abstandshalter zum Ausrichten des Verlängerungsbolzens
 - ✓ Klemmblock zum Einpressen der Klammer
- Stellen Sie den ersten Comfortzylinder AX mit dem mechanischen Knauf nach oben in das Knauf-Montagewerkzeug.
  35
 - Haken Sie die Spitze des Aushebers in die Klammer ein.
  36
 - Hebeln Sie die Klammer aus dem Profilzylinder, indem Sie den Ausheber in die Mitte des Zylinders bewegen.
  37
 - Ziehen Sie die Klammer vollständig aus dem Profilzylinder.
  38
 - Nehmen Sie die beiden Zylinderhälften auseinander.
  39
 - ↳ Erste Zylinderhälfte mit Mittelstück und Mitnehmerbart vorbereitet.
 - Stellen Sie den zweiten Comfortzylinder AX mit dem elektronischen Knauf nach oben in das Knauf-Montagewerkzeug.
  40
 - Haken Sie die Spitze des Aushebers in die Klammer ein.
  41
 - Hebeln Sie die Klammer aus dem Profilzylinder, indem Sie den Ausheber in die Mitte des Zylinders bewegen.
  42
 - Ziehen Sie die Klammer vollständig aus dem Profilzylinder.
  43
 - Nehmen Sie die beiden Zylinderhälften auseinander.
  44
 - ↳ Zweite Zylinderhälfte ohne Mittelstück vorbereitet.
 - Setzen Sie die erste Zylinderhälfte auf die zweite Zylinderhälfte.
  45
 - Setzen Sie die Klammer mit der Nase zur Stulpschraube wieder in den Schlitz des Profilzylinders ein.
  46
 - Setzen Sie den Zylinder in den Klemmblock ein, sodass der Profilzylinder und der Knauf bündig in den Aussparungen liegen.
  47
 - ↳ Der Hebel des Klemmblocks ist an einer Stelle mit einem Metallplättchen verstärkt. Die vorhin eingeschobene Klammer liegt gegenüber dieses Metallplättchens.
 - Drücken Sie den Hebel des Klemmblocks zur Bodenplatte, bis die Klammer wieder vollständig im Profilzylinder sitzt.
  48
 - ↳ Freidrehender Zylinder fertig zusammengesetzt.

7. CO-Zylinder zu HZ reduzieren















Aus einem AX-Comfortzylinder oder einem freidrehenden Zylinder können Sie mit einem speziellen Mittelstück einen Halbzylinder zusammensetzen.

- ✓ Ausheber zum Lösen der Klammer
 - ✓ Abstandshalter zum Ausrichten des Verlängerungsbolzens
 - ✓ Klemmblock zum Einpressen der Klammer
 - ✓ Halbzylinder-Mittelstück
- Stellen Sie den Cylinder AX mit dem elektronischen Knauf nach oben in das Knauf-Montagewerkzeug.
  50
 - Haken Sie die Spitze des Aushebers in die Klammer ein.
  51
 - Hebeln Sie die Klammer aus dem Profilzylinder, indem Sie den Ausheber in die Mitte des Zylinders bewegen.
  52
 - Ziehen Sie die Klammer vollständig aus dem Profilzylinder.
 - Nehmen Sie die beiden Zylinderhälften auseinander.
  53
 - ↳ Erste Zylinderhälfte ohne Mittelstück vorbereitet.
 - Legen Sie den Abstandshalter an das Halbzylinder-Mittelstück an.
  54
 - Schrauben Sie mit dem Ausheber einen passenden Verlängerungsbolzen ein, bis er am Abstandshalter anliegt.
  55
 - Stellen Sie die vorbereitete Zylinderhälfte in das Knauf-Montagewerkzeug.
  56
 - Setzen Sie das Halbzylinder-Mittelstück auf die vorbereitete Zylinderhälfte.
  57
 - ↳ Verlängerungsbolzen ist gegen Verdrehen geschützt.

10. Ziehen Sie den Abstandshalter wieder ab.
 58
11. Schieben Sie die Zylinderteile vollständig zusammen.
 59
12. Setzen Sie die Klammer mit der Nase zur Stulpschraube wieder in den Schlitz des Profilzylinders ein.
 60
13. Setzen Sie den Zylinder in den Klemmblock ein, sodass der Profilzylinder und der Knauf bündig in den Aussparungen liegen.
 61
↳ Der Hebel des Klemmblocks ist an einer Stelle mit einem Metallplättchen verstärkt. Die vorhin eingeschobene Klammer liegt gegenüber dieses Metallplättchens.
14. Drücken Sie den Hebel des Klemmblocks zur Bodenplatte, bis die Klammer wieder vollständig im Profilzylinder sitzt.
 62
↳ Halbzylinder AX ist fertig zusammengesetzt.

8. Mitnehmer austauschen

- ✓ Ausheber zum Lösen der Klammer vorhanden.
- ✓ Abstandshalter zum Ausrichten des Verlängerungsbolzens vorhanden.
- ✓ Geeignetes Werkzeug zum Einpressen der Klammer (z.B. Klemmblock oder Armaturenzange) vorhanden.

1. Stellen Sie den Digital Cylinder AX in das Knauf-Montagewerkzeug.
 63
2. Haken Sie die Spitze des Aushebers in die Klammer ein.
 64
3. Hebeln Sie die Klammer aus dem Profilzylinder, indem Sie den Ausheber in die Mitte des Zylinders bewegen.
 65
4. Ziehen Sie die Klammer vollständig aus dem Profilzylinder.
 66
5. Nehmen Sie die beiden Zylinderhälften auseinander.
 67
6. Haken Sie die Spitze des Aushebers in die zweite Klammer ein.
 68
7. Hebeln Sie die zweite Klammer aus dem Profilzylinder, indem Sie den Ausheber in die Mitte des Zylinders bewegen.
 69
8. Ziehen Sie die zweite Klammer vollständig aus dem Profilzylinder.
 70
9. Drehen Sie beide Verlängerungsbolzen heraus.
 71
10. Entfernen Sie den Mitnehmer.
 72
11. Setzen Sie einen neuen Mitnehmer ein.
 73
12. Legen Sie den Abstandshalter an.
 74
13. Schrauben Sie mit dem Ausheber einen passenden Verlängerungsbolzen ein, bis er am Abstandshalter anliegt.



HINWEIS

Länge auf Bolzenkopf

Sie finden auf dem Bolzenkopf eine Zahl. Diese Zahl ist die Länge des Zylinderprofils, zu dem der Bolzen passt.



75

14. Stecken Sie eine Zylinderhälfte auf den Verlängerungsbolzen.



76

- ↳ Verlängerungsbolzen ist gegen Verdrehen geschützt.

15. Ziehen Sie den Abstandshalter wieder ab.



77

16. Schieben Sie die Hälften vollständig zusammen.



78

17. Setzen Sie die Klammer mit der Nase zur Stulpschraube wieder in den Schlitz des Profilzylinders ein und drücken Sie die Klammer mit dem Daumen fest, damit sie nicht mehr herausfallen kann.
18. Pressen Sie die Klammer mit einem geeigneten Werkzeug in den Profilzylinder (z.B. Klemmblock oder Armaturenzange).



HINWEIS

Klemmblock mit Austausch-Mitnehmern inkompatibel

Eine Austausch-Mitnehmer passen nicht in die Aussparung des Klemmblocks. Bei Zylindern mit diesen Mitnehmern können die Klammern nicht mit dem Klemmblock eingepresst werden.



79

19. Legen Sie den Abstandshalter erneut an.



74

20. Schrauben Sie mit dem Ausheber einen passenden Verlängerungsbolzen ein, bis er am Abstandshalter anliegt.



HINWEIS

Länge auf Bolzenkopf

Sie finden auf dem Bolzenkopf eine Zahl. Diese Zahl ist die Länge des Zylinderprofils, zu dem der Bolzen passt.



81

21. Stecken Sie eine Zylinderhälfte auf den Verlängerungsbolzen.

- ↳ Verlängerungsbolzen ist gegen Verdrehen geschützt.



82

22. Ziehen Sie den Abstandshalter wieder ab.



83

23. Schieben Sie die Hälften vollständig zusammen.



84

24. Setzen Sie die Klammer mit der Nase zur Stulpschraube wieder in den Schlitz des Profilzylinders ein und drücken Sie die Klammer mit dem Daumen fest, damit sie nicht mehr herausfallen kann.
25. Pressen Sie die Klammer mit einem geeigneten Werkzeug in den Profilzylinder (z.B. Klemmblock oder Armaturenzange).



HINWEIS

Klemmblock mit Austausch-Mitnehmern inkompatibel

Eine Austausch-Mitnehmer passen nicht in die Aussparung des Klemmblocks. Bei Zylindern mit diesen Mitnehmern können die Klammern nicht mit dem Klemmblock eingepresst werden.



85

- ↳ Mitnehmer am Digital Cylinder AX ist ausgetauscht.



86

9. Hilfe und weitere Informationen

Infomaterial/Dokumente

<https://www.simons-voss.com/de/dokumente.html>

<https://www.smartintego.com/de/home/infocenter/dokumentation>

Konformitätserklärungen und Zertifikate

<https://www.simons-voss.com/de/zertifikate.html>

Technischer Support

+49 (0) 89 / 99 228 333

E-Mail

support-simonsvoss@allegion.com

si-support-simonsvoss@allegion.com

FAQ

<https://faq.simons-voss.com/otrs/public.pl>

SimonsVoss Technologies GmbH, Feringastr. 4, D-85774 Unterfoehring, Deutschland

Contents

1.	General safety instructions	41
2.	Product-specific safety instructions	41
3.	Accessories and tools	41
3.1	Length modularity	41
3.2	Cam	41
3.3	Tools	42
4.	Extend Cylinder AX	42
5.	Shorten Cylinder AX	42
6.	Combine CO cylinders to FD	43
7.	Reduce CO cylinders to HZ	43
8.	Replacing the cam	44
9.	Help and other information	44

1. General safety instructions

Signal word: Possible immediate effects of non-compliance

WARNING: Death or serious injury (possible, but unlikely)**IMPORTANT:** Property damage or malfunction, **NOTE:** Low or none



WARNING

Blocked access

Access through a door may stay blocked due to incorrectly fitted and/or incorrectly programmed components. SimonsVoss Technologies GmbH is not liable for the consequences of blocked access such as access to injured or endangered persons, material damage or other damage!

Blocked access through manipulation of the product

If you change the product on your own, malfunctions can occur and access through a door can be blocked.

- Modify the product only when needed and only in the manner described in the documentation.

IMPORTANT

Damage resulting from liquids

This product contains electronic and/or mechanic components that may be damaged by liquids of any kind.

- Keep liquids away from the electronics.

Damage resulting from aggressive cleaning agents

The surface of this product may be damaged as a result of the use of unsuitable cleaning agents.

- Only use cleaning agents that are suitable for plastic or metal surfaces.



NOTE

Intended use

SimonsVoss-products are designed exclusively for opening and closing doors and similar objects.

- Do not use SimonsVoss products for any other purposes.

Qualifications required

The installation and commissioning requires specialized knowledge.

- Only trained personnel may install and commission the product.

Modifications or further technical developments cannot be excluded and may be implemented without notice.

The German language version is the original instruction manual. Other languages (drafting in the contract language) are translations of the original instructions.

Read and follow all installation, installation, and commissioning instructions. Pass these instructions and any maintenance instructions to the user.

2. Product-specific safety instructions



WARNING

Malfunction of the anti-panic function due to unauthorised manipulation



In its anti-panic version, the Digital Cylinder AX has a permanently installed anti-panic module and is modular in length to a limited extent; outer side as required, inner side from 50 mm and half cylinder from 50 mm.

- Do not attempt to dismantle the anti-panic module as this may damage it.
- Perform a battery test every time that you modify it.

3. Accessories and tools



3.1 Length modularity

The profile cylinder can be extended and shortened with the following parts:

Extension bolt	Core extension for the profile	Profile extension
 <ul style="list-style-type: none"> Z5.BOLT.XX (XX = required basic length) 	 <ul style="list-style-type: none"> Z5.CORE.05: 5 mm Z5.CORE.10: 10 mm Z5.CORE.20: 20 mm 	 <ul style="list-style-type: none"> Z5.PROFILE.05: 5 mm Z5.PROFILE.10: 10 mm Z5.PROFILE.20: 20 mm

Clamps
 <ul style="list-style-type: none"> Z5.CLAMPS <p>Set contains 50 units.</p>



Cylinder centre piece	Half cylinder centre piece	Half cylinder centre section with multi-point
 <ul style="list-style-type: none"> Z5.CNT.EU 	 <ul style="list-style-type: none"> Z5.CNT.HZ 	 <ul style="list-style-type: none"> Z5.CNT.HZ.MR

Inner thumb-turn mount	Inside blank profile without thumb-turn	Thumb-turn mount for glass door thumb-turn
 <ul style="list-style-type: none"> Z5.PR.IN 	 <p>For .OK variant</p> <ul style="list-style-type: none"> Z5.PR.OK 	 <p>Profile length 30 mm (extendible)</p> <ul style="list-style-type: none"> Z5.PR.GD

3.2 Cam

You can also choose between different cams:



Standard cam	Cam PM1 (long)	Cam PM2 (short)
 <ul style="list-style-type: none"> Z5.CAM.WP 	 <ul style="list-style-type: none"> Z5.CAM.PM1 	 <ul style="list-style-type: none"> Z5.CAM.PM2

Double cam	Cam gear, 10 teeth	Cam gear, 18 teeth
		
■ Z5.CAM.DOUBLE	■ Z5.CAM.GEAR10	■ Z5.GEAR.18

3.3 Tools

Various tools are available to adjust the Digital Cylinder AX:

Lifter (Z5.LIFTER)	Spacer (Z5.SPACER)	Terminal block (Z5.BLOCK)
		

The Digital Cylinder AX thumb turn installation tool is designed so that you can use it to hold the Digital Cylinder AX in place. Position it with the flat side on a flat surface and place the Digital Cylinder AX together with the thumb-turn in the installation tool. Reassembly is easier when the Digital Cylinder AX is in the holder.



2

4. Extend Cylinder AX



3

The core extension and profile extension must be the same length. You also need an extension bolt for the desired length.

- ✓ Extractor for releasing the clamp
- ✓ Spacer for aligning the extension bolt
- ✓ Clamp block for pressing in the clamp

1. Place the Cylinder AX in the thumb-turn assembly tool.



4

2. Hook the tip of the extractor into the clamp.



5

3. Lever the clamp out of the profile cylinder by moving the extractor to the centre of the cylinder.



6

4. Pull the clamp completely out of the profile cylinder.



7

5. Disassemble the two cylinder halves.



8

6. Use the extractor to unscrew the extension bolt.



9

7. Insert suitable core extensions.

8. Attach suitable profile extensions.



10

9. Place the spacer.



11

10. Screw in a suitable extension bolt with the extractor until it rests on the spacer.



NOTE

Length on bolt head

You will find a number on the bolt head. This number is the length of the cylinder profile to which the bolt fits.



12

11. Reassemble the two cylinder halves.



13

- ↳ Extension bolt is protected against twisting.

12. Pull the spacer off again.



14

13. Push the halves together completely.



15

14. Place the clip back into the slot of the profile cylinder with its lug facing the fastening screw and press the clamp with your thumb so that it can no longer fall out.



16

15. Insert the cylinder into the clamping block so that the profile cylinder and the thumb-turn lie flush in the recesses.



17

- ↳ The lever of the clamping block is reinforced at one point with a metal plate. The bracket that was previously inserted lies opposite this metal plate.

16. Push the clamp block lever towards the base plate until the clamp is fully seated in the profile cylinder.



18

- ↳ Cylinder AX is extended.

5. Shorten Cylinder AX



18

You need a bolt for the desired length.

- ✓ Extractor for releasing the clamp
- ✓ Spacer for aligning the bolt
- ✓ Clamp block for pressing in the clamp

1. Place the Cylinder AX in the thumb-turn assembly tool.



19

2. Hook the tip of the extractor into the clamp.



20

3. Lever the clamp out of the profile cylinder by moving the extractor to the centre of the cylinder.



21

4. Pull the clamp completely out of the profile cylinder.



22

5. Disassemble the two cylinder halves.



23

6. Unscrew the bolt with the extractor.



24

7. Remove the profile extension.

8. Remove the core extension.



25

9. Place the spacer.



26

10. Screw in a suitable bolt with the extractor until it rests on the spacer.



NOTE

Length on bolt head

You will find a number on the bolt head. This number is the length of the cylinder profile to which the bolt fits.







27

11. Reassemble the two cylinder halves.















28



- ↳ Bolt is protected against twisting.
- 12. Pull the spacer off again.  29
- 13. Push the halves together completely.  30
- 14. Refit the clip into the slot of the profile cylinder with the lug facing the fastening screw.  31
- 15. Insert the cylinder into the clamping block so that the profile cylinder and the thumb-turn lie flush in the recesses.  32
 - ↳ The lever of the clamping block is reinforced at one point with a metal plate. The bracket that was previously inserted lies opposite this metal plate.
- 16. Push the clamp block lever towards the base plate until the clamp is fully seated in the profile cylinder.  33
- ↳ Cylinder AX is shortened.

6. Combine CO cylinders to FD



You can assemble a freely rotating AX cylinder from two AX comfort cylinders.













- ✓ Extractor for releasing the clamp
 - ✓ Spacer for aligning the extension bolt
 - ✓ Clamp block for pressing in the clamp
1. Place the first comfort cylinder AX in the thumb-turn assembly tool with the mechanical thumb-turn facing upwards.  35
 2. Hook the tip of the extractor into the clamp.  36
 3. Lever the clamp out of the profile cylinder by moving the extractor to the centre of the cylinder.  37
 4. Pull the clamp completely out of the profile cylinder.  38
 5. Disassemble the two cylinder halves.  39
 - ↳ First cylinder half prepared with centre piece and tappet piece.
 6. Place the second comfort cylinder AX in the thumb-turn assembly tool with the electronic thumb-turn facing upwards.  40
 7. Hook the tip of the extractor into the clamp.  41
 8. Lever the clamp out of the profile cylinder by moving the extractor to the centre of the cylinder.  42
 9. Pull the clamp completely out of the profile cylinder.  43
 10. Disassemble the two cylinder halves.  44
 - ↳ Second cylinder half prepared without centre piece.
 11. Place the first cylinder half on the second cylinder half.  45
 12. Refit the clip into the slot of the profile cylinder with the lug facing the fastening screw.  46

13. Insert the cylinder into the clamping block so that the profile cylinder and the thumb-turn lie flush in the recesses.  47
 - ↳ The lever of the clamping block is reinforced at one point with a metal plate. The bracket that was previously inserted lies opposite this metal plate.
14. Push the clamp block lever towards the base plate until the clamp is fully seated in the profile cylinder.  48
- ↳ Freely rotating cylinder fully assembled.













7. Reduce CO cylinders to HZ



You can use a special centre piece to assemble a half cylinder from an AX comfort cylinder or a freely rotating cylinder.

- ✓ Extractor for releasing the clamp
 - ✓ Spacer for aligning the extension bolt
 - ✓ Clamp block for pressing in the clamp
 - ✓ Half Cylinder Center Section
1. Place the Cylinder AX in the thumb-turn assembly tool with the electronic thumb-turn facing upwards.  50
 2. Hook the tip of the extractor into the clamp.  51
 3. Lever the clamp out of the profile cylinder by moving the extractor to the centre of the cylinder.  52
 4. Pull the clamp completely out of the profile cylinder.  53
 - ↳ First cylinder half prepared without centre piece.
 5. Disassemble the two cylinder halves.  54
 6. Place the spacer on the half-cylinder centre piece.  55
 7. Screw in a suitable extension bolt with the extractor until it rests on the spacer.  56
 8. Place the prepared cylinder half in the thumb-turn assembly tool.  57
 - ↳ Extension bolt is protected against twisting.
 9. Place the half cylinder centre piece on the prepared cylinder half.  58
 10. Pull the spacer off again.  59
 11. Push the cylinder parts together completely.  60
 12. Refit the clip into the slot of the profile cylinder with the lug facing the fastening screw.  61
 - ↳ The lever of the clamping block is reinforced at one point with a metal plate. The bracket that was previously inserted lies opposite this metal plate.
 13. Insert the cylinder into the clamping block so that the profile cylinder and the thumb-turn lie flush in the recesses.  62
 - ↳ Half cylinder AX is fully assembled.

8. Replacing the cam





- ✓ Lifter for releasing clamp present.
 - ✓ Spacer for aligning the extension bolt are present.
 - ✓ Suitable tool for pressing the clamp in (e.g. clamping block or fitting pliers) is available.
1. Place the Digital Cylinder AX in the thumb turn installation tool.
  63
 2. Attach the tip of the lifter into the clamp.
  64
 3. Lever the clamp out of the profile cylinder by positioning the lifter in the centre of the cylinder.
  65
 4. Pull the clamp out of the profile cylinder completely.
  66
 5. Disassemble the two halves of the cylinder.
  67
 6. Attach the tip of the lifter into the second clamp.
  68
 7. Lever the second clamp out of the profile cylinder by positioning the lifter in the centre of the cylinder.
  69
 8. Pull the second clamp completely out of the profile cylinder.
  70
 9. Unscrew both extension bolts.
  71
 10. Remove the cam.
  72
 11. Insert a new cam.
  73
 12. Fit the spacer.
  74
 13. Using the lifter, screw in a suitable extension bolt until it is in contact with the spacer.



NOTE

Length on bolt head

You will find a number on the bolt head. This number is the length of the cylinder profile to which the bolt fits.



-  75
 14. Place one half of the cylinder on the extension bolt.
  76
 - ↳ Extension bolt is protected against twisting.
 15. Detach the spacer again.
  77
 16. Push the halves together completely.
  78
 17. Insert the clamp with the tab facing the fastening screw back into the slot in the profile cylinder. Then press the clamp firmly with your thumb so that it can no longer fall out.
 18. Press the clamp into the profile cylinder with a suitable tool (e.g. clamping block or fitting pliers).



NOTE

Clamping block incompatible with replacement cams

Some replacement cams do not fit into the recess in the clamping block. On cylinders with these cams, the clamps cannot be pressed in with the clamping block.





-  79
 19. Refit the spacer.
  74
 20. Using the lifter, screw in a suitable extension bolt until it is in contact with the spacer.



NOTE

Length on bolt head

You will find a number on the bolt head. This number is the length of the cylinder profile to which the bolt fits.

-  81
 21. Place one half of the cylinder on the extension bolt.
 - ↳ Extension bolt is protected against twisting.
 -  82
 22. Detach the spacer again.
  83
 23. Push the halves together completely.
  84
 24. Insert the clamp with the tab facing the fastening screw back into the slot in the profile cylinder. Then press the clamp firmly with your thumb so that it can no longer fall out.
 25. Press the clamp into the profile cylinder with a suitable tool (e.g. clamping block or fitting pliers).



NOTE

Clamping block incompatible with replacement cams

Some replacement cams do not fit into the recess in the clamping block. On cylinders with these cams, the clamps cannot be pressed in with the clamping block.

-  85
 - ↳ Cam on the Digital Cylinder AX has been replaced.
  86

9. Help and other information

Information material/documents

<https://www.simens-voss.com/en/documents.html>

<https://www.smartintego.com/int/home/infocenter/documentation>

Declarations of conformity

<https://www.simens-voss.com/en/certificates.html>

Technical support

+49 (0) 89 / 99 228 333

Email

support-simensvoss@allegion.com
si-support-simensvoss@allegion.com

FAQs

<https://faq.simens-voss.com/otrs/public.pl>

SimonsVoss Technologies GmbH, Feringastr. 4, D-85774 Unterfoehring, Germany

Tables des matières

1.	Consignes de sécurité générales	46
2.	Consignes de sécurité propres au produit	46
3.	Accessoires et outils.....	46
3.1	Modularité de longueur.....	46
3.2	Panneton	47
3.3	Outils.....	47
4.	Extension du cylindre AX.....	47
5.	Raccourcissement du cylindre AX.....	47
6.	Combinaison de cylindres CO en un FD.....	48
7.	Réduction d'un cylindre CO en un HZ.....	48
8.	Remplacement du panneton.....	49
9.	Aide et autres informations.....	50

1. Consignes de sécurité générales

Mot indicateur: Effets immédiats possibles du non-respect

AVERTISSEMENT: Mort ou blessure grave (possible, mais improbable) AT-TENTION: Dommages matériels ou dysfonctionnements, NOTE: Peu ou pas



AVERTISSEMENT

Accès bloqué

Toute erreur de montage et/ou de programmation d'un composant peut bloquer l'accès par une porte. La société SimonsVoss Technologies GmbH décline toute responsabilité quant aux conséquences d'un accès bloqué, par exemple, accès pour les personnes blessées ou en danger, dommages matériels ou autres dommages !

Accès bloqué par la manipulation du produit

Si vous modifiez vous-même le produit, des dysfonctionnements peuvent se produire et l'accès peut être bloqué par une porte.

- ❑ Ne changer le produit que lorsque cela est nécessaire et de la manière décrite dans la documentation.

ATTENTION

Endommagement lié à des liquides

Ce produit contient des composants électroniques et/ou mécaniques susceptibles d'être endommagés par tout type de liquide.

- ❑ Tenez les liquides à l'écart du système électronique.

Endommagement lié à des nettoyeurs agressifs

La surface de ce produit peut être endommagée par des nettoyeurs inappropriés.

- ❑ Utilisez exclusivement des nettoyeurs adaptés aux surfaces plastiques ou métalliques.



NOTE

Utilisation conforme aux dispositions

Les produits SimonsVoss sont exclusivement destinés à l'ouverture et la fermeture de portes et d'objets similaires.

- ❑ N'utilisez pas les produits SimonsVoss à d'autres fins.

Qualifications requises

L'installation et la mise en service nécessitent des connaissances spécialisées.

- ❑ Seul le personnel qualifié peut installer et mettre en service le produit.

Les modifications et nouveaux développements techniques ne peuvent pas être exclus et peuvent être mis en œuvre sans préavis.

La version allemande est le manuel d'instruction original. Les autres langues (rédaction dans la langue du contrat) sont des traductions des instructions originales.

Lisez et suivez toutes les instructions d'installation, d'installation et de mise en service. Transmettez ces instructions et toutes les instructions de maintenance à l'utilisateur.

2. Consignes de sécurité propres au produit



AVERTISSEMENT

Dysfonctionnement de la fonction antipanique du fait d'une mauvaise manipulation

Dans la variante antipanique, le Digital Cylinder AX est équipé d'un module antipanique fixe et présente une modularité de longueur limitée : Côté extérieur quelconque, côté intérieur à partir de 50 mm et demi-cylindre à partir de 50 mm.

1. N'essayez pas de démonter le module antipanique, car cela pourrait l'endommager.
2. Effectuez un test de fonctionnement antipanique après chaque transformation.

3. Accessoires et outils

3.1 Modularité de longueur

Le cylindre profilé peut être allongé et raccourci à l'aide des pièces suivantes :

Tige d'extension	Extension de base du profil	Extension de profil
 <ul style="list-style-type: none"> ❑ Z5.BOLT.XX (XX=longueur de base souhaitée) 	 <ul style="list-style-type: none"> ❑ Z5.CORE.05 : 5 mm ❑ Z5.CORE.10 : 10 mm ❑ Z5.CORE.20 : 20 mm 	 <ul style="list-style-type: none"> ❑ Z5.PROFILE.05 : 5 mm ❑ Z5.PROFILE.10 : 10 mm ❑ Z5.PROFILE.20 : 20 mm



Clips



- ❑ Z5.CLAMPS







Un kit comprend 50 pièces.

Pièce centrale du cylindre	Pièce centrale du demi-cylindre	Pièce centrale du demi-cylindre avec multicils
 <ul style="list-style-type: none"> ❑ Z5.CNT.EU 	 <ul style="list-style-type: none"> ❑ Z5.CNT.HZ 	 <ul style="list-style-type: none"> ❑ Z5.CNT.HZ.MR

Logement du bouton intérieur	Profilé borgne intérieur sans bouton	Logement de bouton pour bouton de porte en verre
		
■ Z5.PR.IN	Pour version.OK ■ Z5.PR.OK	Longueur de profilé 30 mm (extensible) ■ Z5.PR.GD

3.2 Panneton

Vous avez en plus le choix entre différents pannetons :

Panneton standard	Panneton PM1 (long)	Panneton PM2 (court)
		
■ Z5.CAM.WP	■ Z5.CAM.PM1	■ Z5.CAM.PM2
Panneton double	Panneton pignon 10 dents	Panneton pignon 18 dents
		
■ Z5.CAM.DOUBLE	■ Z5.CAM.GEAR10	■ Z5.GEAR.18

3.3 Outils

Différents outils sont disponibles pour adapter le Digital Cylinder AX :

Clé de levage (Z5.LIF-TER)	Cale (Z5.SPACER)	Bloc de serrage (Z5.BLOCK)
		

L'outil de montage de bouton du Digital Cylinder AX est conçu de manière à pouvoir être utilisé comme support pour le Digital Cylinder AX. Posez-le avec le côté plat sur une surface plane et placez le Digital Cylinder AX avec le bouton dans l'outil de montage. Le remontage est plus facile si le Digital Cylinder AX se trouve dans le support.



4. Extension du cylindre AX



L'extension de base et l'extension de profil doivent avoir les mêmes longueurs. En outre, vous avez besoin d'une tige d'extension de la longueur souhaitée.

- ✓ Clé de levage pour desserrer le clip
- ✓ Cale pour aligner la tige d'extension
- ✓ Bloc de serrage pour poser le clip

1. Placez le cylindre AX dans l'outil de montage de poignée.



2. Accrochez la pointe de la clé de levage dans le clip.



3. Faites lever pour séparer le clip du cylindre profilé en déplaçant le dispositif de levage au milieu du cylindre.



4. Retirez entièrement le clip du cylindre profilé.



5. Démontez les deux moitiés du cylindre.



6. Dévissez la tige d'extension à l'aide de la clé de levage.



7. Insérez des extensions de base adaptées.

8. Mettez en place des extensions de profil adaptées.



9. Placez la cale.



10. Vissez à l'aide de la clé de levage une tige d'extension adaptée jusqu'à ce qu'elle soit en contact avec la cale.



NOTE

Longueur sur la tête de boulon

Sur la tête de boulon, vous trouverez un nombre. Ce nombre correspond à la longueur du profil du cylindre pour lequel le boulon convient.



11. Remontez les deux moitiés du cylindre.



- ↳ La tige d'extension est protégée contre la torsion.

12. Retirez la cale.



13. Rapprochez complètement les deux moitiés.



14. Remplacez le clip avec l'ergot en direction de la vis de maintien dans la fente du cylindre profilé et appuyez fermement sur le clip avec le pouce pour qu'il ne puisse plus tomber.



15. Placez le cylindre dans le bloc de serrage de manière à ce que le cylindre profilé et le bouton affleurent dans les évidements.



- ↳ Une partie du levier du bloc de serrage est renforcée par une petite plaque métallique. Le clip qui a été inséré se trouve en face de cette petite plaque métallique.

16. Poussez le levier du bloc de serrage vers la plaque de base jusqu'à ce que le clip soit entièrement enfoncé dans le cylindre profilé.



- ↳ Le cylindre AX est rallongé.

5. Raccourcissement du cylindre AX



Vous avez besoin d'une tige d'extension de la longueur souhaitée.







- ✓ Clé de levage pour desserrer le clip
- ✓ Cale pour aligner la tige
- ✓ Bloc de serrage pour poser le clip

1. Placez le cylindre AX dans l'outil de montage de poignée.









2. Accrochez la pointe de la clé de levage dans le clip.



- Faites levier pour séparer le clip du cylindre profilé en déplaçant le dispositif de levage au milieu du cylindre.
 21
- Retirez entièrement le clip du cylindre profilé.
 22
- Démontez les deux moitiés du cylindre.
 23
- Dévissez la tige à l'aide de clé de levage.
 24
- Retirez les extensions de profil.
- Retirez les extensions de base.
 25
- Placez la cale.
 26
- Vissez à l'aide de la clé de levage une tige adaptée jusqu'à ce qu'elle soit en contact avec la cale.



**NOTE****Longueur sur la tête de boulon**













Sur la tête de boulon, vous trouverez un nombre. Ce nombre correspond à la longueur du profil du cylindre pour lequel le boulon convient.

-  27
- Remontez les deux moitiés du cylindre.
 28
↳ La tige est protégée contre la torsion.
- Retirez la cale.
 29
- Rapprochez complètement les deux moitiés.
 30
- Remplacez le clip avec l'ergot en direction de la vis de maintien dans la fente du cylindre profilé.
 31
- Placez le cylindre dans le bloc de serrage de manière à ce que le cylindre profilé et le bouton affleurent dans les évidements.
 32
↳ Une partie du levier du bloc de serrage est renforcée par une petite plaque métallique. Le clip qui a été inséré se trouve en face de cette petite plaque métallique.
- Poussez le levier du bloc de serrage vers la plaque de base jusqu'à ce que le clip soit entièrement enfoncé dans le cylindre profilé.
 33
↳ Le cylindre AX est raccourci.

6. Combinaison de cylindres CO en un FD





Vous pouvez assembler deux cylindres confort AX pour former un cylindre AX à rotation libre.









- ✓ Clé de levage pour desserrer le clip
 - ✓ Cale pour aligner la tige d'extension
 - ✓ Bloc de serrage pour poser le clip
- Placez le premier cylindre confort AX avec le bouton mécanique vers le haut dans l'outil de montage de poignée.
 35
 - Accrochez la pointe de la clé de levage dans le clip.
 36

- Faites levier pour séparer le clip du cylindre profilé en déplaçant le dispositif de levage au milieu du cylindre.
 37
- Retirez entièrement le clip du cylindre profilé.
 38
- Démontez les deux moitiés du cylindre.
 39
↳ La première moitié de cylindre est préparée avec pièce centrale et dispositif d'entraînement.
- Placez le deuxième cylindre confort AX avec le bouton électronique vers le haut dans l'outil de montage de poignée.
 40
- Accrochez la pointe de la clé de levage dans le clip.
 41
- Faites levier pour séparer le clip du cylindre profilé en déplaçant le dispositif de levage au milieu du cylindre.
 42
- Retirez entièrement le clip du cylindre profilé.
 43
- Démontez les deux moitiés du cylindre.
 44
↳ La deuxième moitié de cylindre est préparée sans pièce centrale.
- Placez la première moitié de cylindre sur la deuxième moitié de cylindre.
 45
- Remplacez le clip avec l'ergot en direction de la vis de maintien dans la fente du cylindre profilé.
 46
- Placez le cylindre dans le bloc de serrage de manière à ce que le cylindre profilé et le bouton affleurent dans les évidements.
 47
↳ Une partie du levier du bloc de serrage est renforcée par une petite plaque métallique. Le clip qui a été inséré se trouve en face de cette petite plaque métallique.
- Poussez le levier du bloc de serrage vers la plaque de base jusqu'à ce que le clip soit entièrement enfoncé dans le cylindre profilé.
 48
↳ L'assemblage du cylindre à rotation libre est terminé.

7. Réduction d'un cylindre CO en un HZ











Vous pouvez assembler un demi-cylindre à partir d'un cylindre confort AX ou d'un cylindre à rotation libre à l'aide d'une pièce centrale.



- ✓ Clé de levage pour desserrer le clip
 - ✓ Cale pour aligner la tige d'extension
 - ✓ Bloc de serrage pour poser le clip
 - ✓ Pièce centrale du demi-cylindre
- Placez le cylindre AX avec le bouton électronique vers le haut dans l'outil de montage de poignée.
 50
 - Accrochez la pointe de la clé de levage dans le clip.
 51
 - Faites levier pour séparer le clip du cylindre profilé en déplaçant le dispositif de levage au milieu du cylindre.
 52
 - Retirez entièrement le clip du cylindre profilé.
 - Démontez les deux moitiés du cylindre.
 53
↳ La première moitié de cylindre est préparée sans pièce centrale.

6. Placez la cale sur la pièce centrale du demi-cylindre.
 54
7. Vissez à l'aide de la clé de levage une tige d'extension adaptée jusqu'à ce qu'elle soit en contact avec la cale.
 55
8. Placez la moitié de cylindre préparée dans l'outil de montage de poignée.
 56
9. Placez la pièce centrale du demi-cylindre sur la moitié de cylindre préparée.
 57
↳ La tige d'extension est protégée contre la torsion.
10. Retirez la cale.
 58
11. Rapprochez complètement les parties du cylindre.
 59
12. Remplacez le clip avec l'ergot en direction de la vis de maintien dans la fente du cylindre profilé.
 60
13. Placez le cylindre dans le bloc de serrage de manière à ce que le cylindre profilé et le bouton affleurent dans les évidements.
 61
↳ Une partie du levier du bloc de serrage est renforcée par une petite plaque métallique. Le clip qui a été inséré se trouve en face de cette petite plaque métallique.
14. Poussez le levier du bloc de serrage vers la plaque de base jusqu'à ce que le clip soit entièrement enfoncé dans le cylindre profilé.
 62
↳ L'assemblage du demi-cylindre AX est terminé.

8. Remplacement du panneton

- ✓ Clé de levage pour desserrer le clip disponible.
- ✓ Cale pour aligner la tige d'extension disponible.
- ✓ Outil approprié pour emmancher le clip (par ex. bloc de serrage ou pince à robinetterie) disponible.

1. Placez le Digital Cylinder AX dans l'outil de montage de bouton.
 63
2. Accrochez la pointe de la clé de levage dans le clip.
 64
3. Faites levier pour séparer le clip du cylindre profilé en déplaçant la clé de levage au milieu du cylindre.
 65
4. Retirez entièrement le clip du cylindre profilé.
 66
5. Démontez les deux moitiés du cylindre.
 67
6. Accrochez la pointe de la clé de levage dans le deuxième clip.
 68
7. Faites levier pour séparer le clip du cylindre profilé en déplaçant la clé de levage au milieu du cylindre.
 69
8. Retirez entièrement le deuxième clip du cylindre profilé.
 70
9. Dévissez les deux tiges d'extension.
 71
10. Retirez le panneton.
 72





11. Introduisez le panneton neuf.
 73
12. Placez la cale.
 74
13. Vissez à l'aide de la clé de levage une tige d'extension adaptée jusqu'à ce qu'elle soit en contact avec la cale.



NOTE

Longueur sur la tête de boulon

Sur la tête de boulon, vous trouverez un nombre. Ce nombre correspond à la longueur du profil du cylindre pour lequel le boulon convient.



-  75
14. Emmanchez un demi-cylindre sur la tige d'extension.
 76
↳ La tige d'extension est protégée contre la torsion.
15. Retirez la cale.
 77
16. Rapprochez complètement les deux moitiés.
 78
17. Remplacez le clip avec l'ergot en direction de la vis de maintien dans la fente du cylindre profilé et appuyez fermement sur le clip avec le pouce pour qu'il ne puisse plus tomber.
18. Enfoncez le clip dans le cylindre profilé à l'aide d'un outil approprié (par ex. un bloc de serrage ou une pince à robinetterie).



NOTE

Bloc de serrage incompatible avec les pannetons de rechange

Certains pannetons de rechange ne s'adaptent pas dans la réservation du bloc de serrage. Pour les cylindres pourvus de ces pannetons, les clips ne peuvent pas être enfoncés avec le bloc de serrage.





-  79
19. Remettez la cale en place.
 74
20. Vissez à l'aide de la clé de levage une tige d'extension adaptée jusqu'à ce qu'elle soit en contact avec la cale.



NOTE

Longueur sur la tête de boulon

Sur la tête de boulon, vous trouverez un nombre. Ce nombre correspond à la longueur du profil du cylindre pour lequel le boulon convient.

-  81
21. Emmanchez un demi-cylindre sur la tige d'extension.
↳ La tige d'extension est protégée contre la torsion.
 82
22. Retirez la cale.
 83
23. Rapprochez complètement les deux moitiés.
 84
24. Remplacez le clip avec l'ergot en direction de la vis de maintien dans la fente du cylindre profilé et appuyez fermement sur le clip avec le pouce pour qu'il ne puisse plus tomber.
25. Enfoncez le clip dans le cylindre profilé à l'aide d'un outil approprié (par ex. un bloc de serrage ou une pince à robinetterie).

**NOTE****Bloc de serrage incompatible avec les pannetons de recharge**

Certains pannetons de recharge ne s'adaptent pas dans la réservation du bloc de serrage. Pour les cylindres pourvus de ces pannetons, les clips ne peuvent pas être enfoncés avec le bloc de serrage.



85

↳ Le panneton sur le Digital Cylinder AX est remplacé.



86

9. Aide et autres informations

Documentation/documents

<https://www.simons-voss.com/fr/documents.html>

<https://www.smartintego.com/fr/home/infocenter/documentations>

Déclarations de conformité

<https://www.simons-voss.com/fr/certificats.html>

Assistance technique

+49 (0) 89 / 99 228 333

E-Mail

support-simonsvoss@allegion.com

si-support-simonsvoss@allegion.com

FAQ

<https://faq.simons-voss.com/otrs/public.pl>

SimonsVoss Technologies GmbH, Feringastr. 4, D-85774 Unterfoehring, Allemagne

Inhoudsopgave

1.	Algemene veiligheidsinstructies	52
2.	Specifieke veiligheidsinstructies per product	52
3.	Accessoires en gereedschappen	52
3.1	lengtemodulariteit	52
3.2	Meenemers	52
3.3	Gereedschappen	53
4.	Cilinder AX verlengen	53
5.	Cilinder AX inkorten	53
6.	CO-cilinder met FD combineren	54
7.	CO-cilinder tot HZ reduceren	54
8.	Meenemer vervangen	55
9.	Hulp en verdere informatie	55

1. Algemene veiligheidsinstructies

Signaalwoord: Mogelijke onmiddellijke gevolgen van niet-naleving
WAARSCHUWING: Dood of ernstig letsel (mogelijk, maar onwaarschijnlijk)
LET OP: Materieel schade of storing, **OPMERKING:** Laag of nee



WAARSCHUWING

Geblokkeerde toegang

Door foutief geïnstalleerde en/of geprogrammeerde componenten kan de doorgang door een deur geblokkeerd blijven. Voor gevolgen van een geblokkeerde toegang tot gewonden of personen in gevaar, materiële of andere schade, is SimonsVoss Technologies GmbH niet aansprakelijk.

Geblokkeerde toegang als gevolg van manipulatie van het product

Als u het product zelf wijzigt, kunnen er storingen optreden en kan de toegang worden geblokkeerd door een deur.

- Vervang het product alleen wanneer dat nodig is en op de manier die in de documentatie wordt beschreven.

LET OP

Beschadiging door vloeistoffen

Dit product heeft elektronische en/of mechanische componenten die kunnen worden beschadigd door elk type vloeistof.

- Houd vloeistoffen uit de buurt van de elektronica.

Beschadiging door bijtende reinigingsmiddelen

Het oppervlak van dit product kan worden beschadigd door ongeschikte reinigingsmiddelen.

- Maak uitsluitend gebruik van reinigingsmiddelen die geschikt zijn voor kunststof of metalen oppervlakken.



OPMERKING

Beoogd gebruik

SimonsVoss-producten zijn uitsluitend bedoeld voor het openen en sluiten van deuren en vergelijkbare voorwerpen.

- Gebruik SimonsVoss-producten niet voor andere doeleinden.

Kwalificaties vereist

De installatie en inbedrijfstelling vereist gespecialiseerde kennis. Alleen getraind personeel mag het product installeren en in bedrijf stellen.

Aanpassingen of nieuwe technische ontwikkelingen kunnen niet uitgesloten worden en worden gerealiseerd zonder aankondiging.

De Duitse taalversie is de originele handleiding. Andere talen (opstellen in de contracttaal) zijn vertalingen van de originele instructies.

Lees en volg alle installatie-, installatie- en inbedrijfstellingsinstructies. Geef deze instructies en eventuele onderhoudsinstructies door aan de gebruiker.

2. Specifieke veiligheidsinstructies per product



WAARSCHUWING

Storing van de anti-paniekfunctie door ongeoorloofde manipulatie

De Digital Cylinder AX heeft in de antipaniekvariant een vast ingebouwde antipaniekmodule en is beperkt lengtemodulair; buitenzijde naar keuze, binnenzijde vanaf 50 mm en halve cilinder vanaf 50 mm.

1. Probeer niet om de antipaniekmodule te demonteren, want deze kan anders beschadigd raken.
2. Voer na elke ombouw een test van de antipaniekfunctie uit.

3. Accessoires en gereedschappen

3.1 lengtemodulariteit

De profielcilinder kan met de volgende onderdelen verlengd en ingekort worden:

Verlengingspin	Kernverlengstuk van het profiel	Profielverlengstuk
		
■ Z5.BOLT.XX (XX=gewenste basislengte)	■ Z5.CORE.05: 5 mm ■ Z5.CORE.10: 10 mm ■ Z5.CORE.20: 20 mm	■ Z5.PROFILE.05: 5 mm ■ Z5.PROFILE.10: 10 mm ■ Z5.PROFILE.20: 20 mm

Klem



- Z5.CLAMPS

Een set bevat 50 stuks.



Middenstuk van de cilinder	Middenstuk van de halve cilinder	Halfcilinder-middenstuk met multirast
		
■ Z5.CNT.EU	■ Z5.CNT.HZ	■ Z5.CNT.HZ.MR



Knophouder binnen	Blindprofiel binnen zonder knop	Knophouder voor glazen deurknop
		
■ Z5.PR.IN	Voor variant .OK ■ Z5.PR.OK	Profiellengte 30 mm (verlengbaar) ■ Z5.PR.GD

3.2 Meenemers

Bovendien kunt u kiezen uit verschillende meenemers:



Meenemer standaard	Meenemer PM1 (lang)	Meenemer PM2 (kort)
		
■ Z5.CAM.WP	■ Z5.CAM.PM1	■ Z5.CAM.PM2

Dubbele meenemer	Meenemer tandwiel 10 tanden	Meenemer tandwiel 18 tanden
		
■ Z5.CAM.DOUBLE	■ Z5.CAM.GEAR10	■ Z5.GEAR.18

3.3 Gereedschappen

Voor het aanpassen van de Digital Cylinder AX zijn verschillende gereedschappen beschikbaar:

krik (Z5.LIFTER)	afstandhouder (Z5.SPACER)	klemblok (Z5.BLOCK)
		

Het montagegereedschap voor de knop van de Digital Cylinder AX is zo geconstrueerd dat u deze als houder voor de Digital Cylinder AX kunt gebruiken. Leg het met de platte zijde op een vlakke ondergrond en plaats de Digital Cylinder AX met de knop in het montagegereedschap. Het opnieuw in elkaar zetten is eenvoudiger als de Digital Cylinder AX in de houder staat.



2

4. Cilinder AX verlengen



3

Het kern- en profielverlengstuk moeten even lang zijn. Daarnaast heeft u een verlengingsbout nodig voor de gewenste lengte.

- ✓ Krik voor het losmaken van de klem
- ✓ Afstandhouder voor het uitlijnen van de verlengingsbout
- ✓ Klemblok voor het inpersen van de klem

1. Plaats de cilinder AX in het montagegereedschap voor de knop.



4

2. Haak het uiteinde van de krik in de klem.



5

3. Til de klem uit de profielcilinder door de krik naar het midden van de cilinder te verplaatsen.



6

4. Trek de klem volledig uit de profielcilinder.



7

5. Demonteer de beide cilinderhelften.



8

6. Draai met de krik de verlengingsbout naar buiten.



9

7. Breng de passende kernverlengstukken aan.

8. Breng de passende profielverlengstukken aan.



10

9. Monteer de afstandhouder.



11

10. Schroef met de krik een passende verlengingsbout in, totdat deze tegen de afstandhouder aanligt.



OPMERKING

Lengte op de kop van de afstandhouder

Op de kop van de afstandhouder is een getal aangebracht. Dit getal is de lengte van het cilinderprofiel waarbij de afstandhouder past.



12

11. Zet de twee cilinderhelften weer in elkaar.



13

- ↳ De verlengingsbout is beveiligd tegen verdraaien.

12. Verwijder de afstandhouder weer.



14

13. Schuif de helften volledig in elkaar.



15

14. Plaats de klem met de neus voor de stiftschroef weer in de sleuf van de profielcilinder en druk de klem met de duim vast, zodat hij er niet meer uit kan vallen.



16

15. Plaats de cilinder in het klemblok, zodat de profielcilinder en de knop vlak in de uitsparingen liggen.



17

- ↳ De hendel van het klemblok is op één plaats met een metalen plaatje versterkt. De eerder ingeschoven klem ligt tegenover dit metalen plaatje.

16. Druk de hendel van het klemblok naar de bodemplaat toe tot de klem weer volledig in de profielcilinder zit.



- ↳ Cilinder AX is verlengd.

5. Cilinder AX inkorten



18

U hebt een bout nodig voor de gewenste lengte.

- ✓ Krik voor het losmaken van de klem
- ✓ Afstandhouder voor het uitlijnen van de bout
- ✓ Klemblok voor het inpersen van de klem

1. Plaats de cilinder AX in het montagegereedschap voor de knop.



19

2. Haak het uiteinde van de krik in de klem.



20

3. Til de klem uit de profielcilinder door de krik naar het midden van de cilinder te verplaatsen.



21

4. Trek de klem volledig uit de profielcilinder.



22

5. Demonteer de beide cilinderhelften.



23

6. Schroef de bout los met de krik.



24

7. Verwijder de profielverlengstukken.

8. Verwijder de kernverlengstukken.



25

9. Monteer de afstandhouder.









26

10. Schroef met de krik een passende bout in totdat deze tegen de afstandhouder aanligt.









**OPMERKING****Langte op de kop van de afstandhouder**





Op de kop van de afstandhouder is een getal aangebracht. Dit getal is de lengte van het cilinderprofiel waarbij de afstandhouder past.

-  27
- 11. Zet de twee cilinderhelften weer in elkaar.
-  28
 - ↳ De bout is beveiligd tegen verdraaien.
- 12. Verwijder de afstandhouder weer.
-  29
- 13. Schuif de helften volledig in elkaar.
-  30
- 14. Plaats de klem met de neus voor de stiftschroef weer in de sleuf van de profielcilinder.
-  31
- 15. Plaats de cilinder in het klemblok, zodat de profielcilinder en de knop vlak in de uitsparingen liggen.
-  32
 - ↳ De hendel van het klemblok is op één plaats met een metalen plaatje versterkt. De eerder ingeschoven klem ligt tegenover dit metalen plaatje.
- 16. Druk de hendel van het klemblok naar de bodemplaat toe tot de klem weer volledig in de profielcilinder zit.
-  33
- ↳ Cilinder AX is korter gemaakt.

6. CO-cilinder met FD combineren











 34
Uit twee AX-comfortcilinders kunt u een vrij draaiende cilinder AX samenstellen.

- ✓ Krik voor het losmaken van de klem
 - ✓ Afstandhouder voor het uitlijnen van de verlengingsbout
 - ✓ Klemblok voor het inpersen van de klem
1. Plaats de eerste comfortcilinder AX met de mechanische knop naar boven in het montagegereedschap van de knop.
 -  35
 2. Haak het uiteinde van de krik in de klem.
 -  36
 3. Til de klem uit de profielcilinder door de krik naar het midden van de cilinder te verplaatsen.
 -  37
 4. Trek de klem volledig uit de profielcilinder.
 -  38
 5. Demonteer de beide cilinderhelften.
 -  39
 - ↳ Eerste cilinderhelft met middenstuk en meenemer voorbereid.
 6. Plaats de tweede comfortcilinder AX met de elektronische knop naar boven in het montagegereedschap van de knop.
 -  40
 7. Haak het uiteinde van de krik in de klem.
 -  41
 8. Til de klem uit de profielcilinder door de krik naar het midden van de cilinder te verplaatsen.
 -  42
 9. Trek de klem volledig uit de profielcilinder.
 -  43

10. Demonteer de beide cilinderhelften.
 -  44
 - ↳ Tweede cilinderhelft zonder middenstuk voorbereid.
11. Plaats de eerste cilinderhelft op de tweede cilinderhelft.
 -  45
12. Plaats de klem met de neus voor de stiftschroef weer in de sleuf van de profielcilinder.
 -  46
13. Plaats de cilinder in het klemblok, zodat de profielcilinder en de knop vlak in de uitsparingen liggen.
 -  47
 - ↳ De hendel van het klemblok is op één plaats met een metalen plaatje versterkt. De eerder ingeschoven klem ligt tegenover dit metalen plaatje.
14. Druk de hendel van het klemblok naar de bodemplaat toe tot de klem weer volledig in de profielcilinder zit.
 -  48
 - ↳ Vrij draaiende cilinder volledig gemonteerd.

7. CO-cilinder tot HZ reduceren

Uit een AX-comfortcilinder of een vrij draaiende cilinder kunt u met een speciaal middenstuk een halve cilinder samenstellen.

- ✓ Krik voor het losmaken van de klem
 - ✓ Afstandhouder voor het uitlijnen van de verlengingsbout
 - ✓ Klemblok voor het inpersen van de klem
 - ✓ Middenstuk van de halve cilinder
1. Plaats de cilinder AX met de elektronische knop naar boven in het montagegereedschap voor de knop.
 -  50
 2. Haak het uiteinde van de krik in de klem.
 -  51
 3. Til de klem uit de profielcilinder door de krik naar het midden van de cilinder te verplaatsen.
 -  52
 4. Trek de klem volledig uit de profielcilinder.
 5. Demonteer de beide cilinderhelften.
 -  53
 - ↳ Eerste cilinderhelft zonder middenstuk voorbereid.
 6. Plaats de afstandhouder tegen het middenstuk van de halve cilinder.
 -  54
 7. Schroef met de krik een passende verlengingsbout in, totdat deze tegen de afstandhouder aanligt.
 -  55
 8. Plaats de voorbereide cilinderhelft in het montagegereedschap voor de knop.
 -  56
 9. Plaats het middenstuk van de halve cilinder op de voorbereide cilinderhelft.
 -  57
 - ↳ De verlengingsbout is beveiligd tegen verdraaien.
 10. Verwijder de afstandhouder weer.
 -  58
 11. Schuif de cilinderdelen volledig in elkaar.
 -  59
 12. Plaats de klem met de neus voor de stiftschroef weer in de sleuf van de profielcilinder.
 -  60

13. Plaats de cilinder in het klemblok, zodat de profielcilinder en de knop vlak in de uitsparingen liggen.



61

- ↳ De hendel van het klemblok is op één plaats met een metalen plaatje versterkt. De eerder ingeschoven klem ligt tegenover dit metalen plaatje.
14. Druk de hendel van het klemblok naar de bodemplaat toe tot de klem weer volledig in de profielcilinder zit.



62

- ↳ Halve cilinder AX is volledig gemonteerd.

8. Meenemer vervangen

- ✓ Krik voor het losmaken van de klem beschikbaar.
- ✓ Afstandhouder voor het uitlijnen van de verlengingsbout beschikbaar.
- ✓ Geschikt gereedschap voor het inpersen van de klem (bijv. klemblok of armatuurtang) beschikbaar.

1. Plaats de Digital Cylinder AX in het montagegereedschap voor de knop.



63

2. Haak het uiteinde van de krik in de klem.



64

3. Til de klem uit de profielcilinder door de krik naar het midden van de cilinder te verplaatsen.



65

4. Trek de klem volledig uit de profielcilinder.



66

5. Demonteer de beide cilinderhelften.



67

6. Haak het uiteinde van de krik in de tweede klem.



68

7. Til de tweede klem uit de profielcilinder door de krik naar het midden van de cilinder te verplaatsen.



69

8. Trek de tweede klem volledig uit de profielcilinder.



70

9. Draai beide verlengbouts naar buiten.



71

10. Verwijder de meenemer.



72

11. Plaats een nieuwe meenemer.



73

12. Monteer de afstandhouder.



74

13. Schroef met de krik een passende verlengingsbout in, totdat deze tegen de afstandhouder aanligt.



OPMERKING

Lengte op de kop van de afstandhouder

Op de kop van de afstandhouder is een getal aangebracht. Dit getal is de lengte van het cilinderprofiel waarbij de afstandhouder past.



75

14. Steek een cilinderhelft op de verlengbout.



76

- ↳ De verlengingsbout is beveiligd tegen verdraaien.

15. Neem de afstandhouder weer af.



77

16. Schuif de helften volledig in elkaar.



78

17. Plaats de klem met de neus voor de stiftschroef weer in de sleuf van de profielcilinder en druk de klem met de duim vast, zodat hij er niet meer uit kan vallen.

18. Druk de klem met een geschikt gereedschap in de profielcilinder (bijv. klemblok of armatuurtang).



OPMERKING

Klemblok incompatibel met vervangende meenemers

Sommige vervangende meenemers passen niet in de uitsparing van het klemblok. Bij cilinders met deze meenemers kunnen de klemmen niet met het klemblok worden ingedrukt.



79

19. Plaats de afstandhouder opnieuw.



74

20. Schroef met de krik een passende verlengingsbout in, totdat deze tegen de afstandhouder aanligt.



OPMERKING

Lengte op de kop van de afstandhouder

Op de kop van de afstandhouder is een getal aangebracht. Dit getal is de lengte van het cilinderprofiel waarbij de afstandhouder past.



81

21. Steek een cilinderhelft op de verlengbout.

- ↳ De verlengingsbout is beveiligd tegen verdraaien.



82

22. Neem de afstandhouder weer af.



83

23. Schuif de helften volledig in elkaar.



84

24. Plaats de klem met de neus voor de stiftschroef weer in de sleuf van de profielcilinder en druk de klem met de duim vast, zodat hij er niet meer uit kan vallen.

25. Druk de klem met een geschikt gereedschap in de profielcilinder (bijv. klemblok of armatuurtang).



OPMERKING

Klemblok incompatibel met vervangende meenemers

Sommige vervangende meenemers passen niet in de uitsparing van het klemblok. Bij cilinders met deze meenemers kunnen de klemmen niet met het klemblok worden ingedrukt.



85

- ↳ Meenemer op Digital Cylinder AX is vervangen.



86

9. Hulp en verdere informatie

Informatiemateriaal/documenten

<https://www.simons-voss.com/nl/documenten.html>

<https://www.smartintego.com/nt/home/infocenter/documentation>

Conformiteitsverklaringen

<https://www.simons-voss.com/nl/certificaten.html>

Technische Support

+49 (0) 89 / 99 228 333

E-mail

support-simonsvoss@allegion.com
si-support-simonsvoss@allegion.com

FAQ

<https://faq.simons-voss.com/otrs/public.pl>

SimonsVoss Technologies GmbH, Feringastr. 4, 85774 Unterföhring,
Duitsland

Sommaro

1.	Avvisi di sicurezza generali	58
2.	Avvertenze di sicurezza specifiche del prodotto	58
3.	Accessori e attrezzi	58
3.1	Modularità in lunghezza	58
3.2	Trascinatoro	59
3.3	Attrezzi	59
4.	Allungamento del cilindro AX	59
5.	Accorciamento del cilindro AX	59
6.	Combinazione di cilindro CO a formare un cilindro FD	60
7.	Riduzione di cilindro CO a formare un semicilindro HZ	60
8.	Sostituzione del trascinatoro	61
9.	Supporto e ulteriori informazioni	62

1. Avvisi di sicurezza generali

Parola segnale: Possibili effetti immediati di non conformità

AVVERTENZA: Morte o lesioni gravi (possibili, ma improbabili) AVVISO: Danni materiali o malfunzionamento, NOTA: Basso o no



AVVERTENZA

Accesso bloccato

Con componenti montati e/o programmati in modo difettoso, l'accesso attraverso una porta può restare bloccato. La SimonsVoss Technologies GmbH non risponde delle conseguenze di un accesso bloccato, per esempio nel caso si debba accedere a persone ferite o in pericolo, di danni a cose o altri danni!

Accesso bloccato tramite manipolazione del prodotto

Se si modifica il prodotto da solo, possono verificarsi malfunzionamenti e l'accesso attraverso una porta può essere bloccato.

- ❑ Modificare il prodotto solo quando necessario e solo nel modo descritto nella documentazione.

AVVISO

Danni dovuti a fluidi

Il presente prodotto contiene componenti elettronici e/o meccanici che potrebbero subire danni dovuti a liquidi di qualunque tipo.

- ❑ Tenere i componenti elettronici lontani da liquidi.

Danni dovuti a detersivi aggressivi

La superficie di questo prodotto può essere danneggiata da detersivi non idonei.

- ❑ Utilizzare esclusivamente detersivi adatti a superfici in plastica o metallo.



NOTA

Uso conforme

I prodotti SimonsVoss sono concepiti esclusivamente per l'apertura e la chiusura di porte e oggetti simili.

- ❑ Non utilizzare i prodotti SimonsVoss per altri scopi.

Qualifiche richieste

L'installazione e la messa in servizio richiedono conoscenze specialistiche.

- ❑ Solo personale qualificato può installare e mettere in servizio il prodotto.

Non si escludono modifiche o perfezionamenti tecnici, anche senza preavvisi.

La versione in lingua tedesca è il manuale di istruzioni originale. Altre lingue (redazione nella lingua del contratto) sono traduzioni delle istruzioni originali.

Leggere e seguire tutte le istruzioni di installazione, installazione e messa in servizio. Passare queste istruzioni e tutte le istruzioni di manutenzione all'utente.

2. Avvertenze di sicurezza specifiche del prodotto



AVVERTENZA

Malfunzionamento della funzione antipanico dovuto a manipolazioni non autorizzate

Il Digital Cylinder AX nella variante antipanico dispone di un modulo antipanico montato in modo fisso ed è modulare in lunghezza in misura limitata: lato esterno a scelta, lato interno da 50 mm e semicilindro da 50 mm.

1. Non cercare di smontare il modulo antipanico, dal momento che si potrebbe danneggiare.
2. Eseguire una prova di funzionamento antipanico dopo ogni conversione.

3. Accessori e attrezzi

3.1 Modularità in lunghezza

Il cilindro profilato può essere allungato e accorciato con le seguenti parti:

Bullone di prolunga	Prolunga del corpo del profilo	Prolunga del profilo
 <ul style="list-style-type: none"> ❑ Z5.BOLT.XX (XX=lunghezza base desiderata) 	 <ul style="list-style-type: none"> ❑ Z5.CORE.05: 5 mm ❑ Z5.CORE.10: 10 mm ❑ Z5.CORE.20: 20 mm 	 <ul style="list-style-type: none"> ❑ Z5.PROFILE.05: 5 mm ❑ Z5.PROFILE.10: 10 mm ❑ Z5.PROFILE.20: 20 mm

Morsetto



- ❑ Z5.CLAMPS







Un set contiene 50 pezzi.

Elemento centrale cilindro	Elemento centrale semicilindro	Elemento centrale semicilindro con Multirast
 <ul style="list-style-type: none"> ❑ Z5.CNT.EU 	 <ul style="list-style-type: none"> ❑ Z5.CNT.HZ 	 <ul style="list-style-type: none"> ❑ Z5.CNT.HZ.MR

Alloggiamento del pomolo interno	Profilo cieco interno senza pomolo	Alloggiamento del pomolo per pomolo di porta a vetri
		
■ Z5.PR.IN	Per variante .OK ■ Z5.PR.OK	Lunghezza profilo 30 mm (allungabile) ■ Z5.PR.GD

3.2 Trascinatore

Inoltre, è possibile scegliere tra diversi trascinatori:

Trascinatore Standard	Trascinatore PMI (lungo)	Trascinatore PM2 (corto)
		
■ Z5.CAM.WP	■ Z5.CAM.PMI	■ Z5.CAM.PM2
Trascinatore doppio	Trascinatore ruota dentata 10 denti	Trascinatore ruota dentata 18 denti
		
■ Z5.CAM.DOUBLE	■ Z5.CAM.GEAR10	■ Z5.GEAR.18

3.3 Attrezzi

Per l'adattamento del Digital Cylinder AX sono disponibili diversi attrezzi:

Estrattore (Z5.LIFTER)	Distanziatore (Z5.SPACER)	Morsettiera (Z5.BLOCK)
		

L'attrezzo di montaggio del pomolo del Digital Cylinder AX è costruito in modo da poter essere utilizzato come supporto per il Digital Cylinder AX. Poggiarlo con il lato piatto su una superficie piana e posizionare il Digital Cylinder AX con il pomolo nell'attrezzo di montaggio. Il riassetto risulta più semplice, se il Digital Cylinder AX è posizionato nel supporto.



2

4. Allungamento del cilindro AX



3

La prolunga del corpo e la prolunga del profilo devono avere la stessa lunghezza. Inoltre è necessario un bullone di prolunga per la lunghezza desiderata.

- ✓ Estrattore per l'allentamento del morsetto
- ✓ Distanziatori per l'allineamento del bullone di prolunga
- ✓ Morsa di fissaggio per pressare il morsetto

1. Posizionare il cilindro AX nell'attrezzo di montaggio del pomolo.



4

2. Agganciare la punta dell'estratteore nel morsetto. 5
3. Fare leva sul morsetto fuori dal cilindro profilato spostando l'estratteore al centro del cilindro. 6
4. Estrarre completamente il morsetto dal cilindro profilato. 7
5. Separare le due metà del cilindro. 8
6. Usare l'estratteore per svitare il bullone di prolunga. 9
7. Inserire prolunghe del corpo adeguate.
8. Applicare le prolunghe del profilo adeguate. 10
9. Posizionare il distanziatore. 11
10. Usando l'estratteore, avvitare un bullone di prolunga adatto fino a quando non poggia contro il distanziatore.



NOTA

Lunghezza su testa bullone

Troverete un numero sulla testa del bullone. Questo numero è la lunghezza del profilo del cilindro per la quale è adatto il bullone.

- 12
11. Rimettere insieme le due metà del cilindro. 13
- ↳ Il bullone di prolunga è protetto dalla torsione.
12. Estrarre di nuovo il distanziatore. 14
13. Spingere le metà insieme completamente. 15
14. Inserire di nuovo il morsetto con il naso rivolto verso la vite a risvolto nella fessura del cilindro profilato e premere il morsetto saldamente con il pollice in modo che non possa più cadere. 16
15. Inserire il cilindro nella morsa di fissaggio in modo che il cilindro profilato e il pomolo siano a filo nelle cavità. 17
- ↳ La leva della morsa di fissaggio è rinforzata in un punto con una piastra metallica. Il morsetto inserito in precedenza si trova di fronte a questa piastra metallica.
16. Spingere la leva della morsa di fissaggio verso la piastra di base fino a quando il morsetto è di nuovo completamente inserito nel cilindro profilato. 18
- ↳ Il cilindro AX è allungato.

5. Accorciamento del cilindro AX



18

È necessario un bullone per la lunghezza desiderata.

- ✓ Estrattore per l'allentamento del morsetto
 - ✓ Distanziatori per l'allineamento del bullone
 - ✓ Morsa di fissaggio per pressare il morsetto
1. Posizionare il cilindro AX nell'attrezzo di montaggio del pomolo. 19
 2. Agganciare la punta dell'estratteore nel morsetto. 20

- Fare leva sul morsetto fuori dal cilindro profilato spostando l'estrattore al centro del cilindro.



21

- Estrarre completamente il morsetto dal cilindro profilato.



22

- Separare le due metà del cilindro.



23

- Usare l'estrattore per svitare il bullone.



24

- Rimuovere le prolunghe del profilo.

- Rimuovere le prolunghe del corpo.



25

- Posizionare il distanziatore.



26

- Usando l'estrattore, avvitare un bullone adatto fino a quando non poggia contro il distanziatore.

- Agganciare la punta dell'estrattore nel morsetto.



36

- Fare leva sul morsetto fuori dal cilindro profilato spostando l'estrattore al centro del cilindro.



37

- Estrarre completamente il morsetto dal cilindro profilato.



38

- Separare le due metà del cilindro.



39

- Prima metà del cilindro preparata con elemento centrale e ingegno del trascinatore.

- Posizionare il secondo cilindro Comfort AX nell'attrezzo di montaggio del pomolo con il pomolo elettronico rivolto verso l'alto.



40

- Agganciare la punta dell'estrattore nel morsetto.



41

- Fare leva sul morsetto fuori dal cilindro profilato spostando l'estrattore al centro del cilindro.



42

- Estrarre completamente il morsetto dal cilindro profilato.



43

- Separare le due metà del cilindro.



44

- Seconda metà del cilindro preparata senza elemento centrale.

- Posizionare la prima metà del cilindro sulla seconda metà del cilindro.



45

- Inserire di nuovo il morsetto con il naso rivolto verso la vite a risvolto nella fessura del cilindro profilato.



46

- Inserire il cilindro nella morsa di fissaggio in modo che il cilindro profilato e il pomolo siano a filo nelle cavità.



47

- La leva della morsa di fissaggio è rinforzata in un punto con una piastra metallica. Il morsetto inserito in precedenza si trova di fronte a questa piastra metallica.

- Spingere la leva della morsa di fissaggio verso la piastra di base fino a quando il morsetto è di nuovo completamente inserito nel cilindro profilato.



48

- Cilindro a rotazione libera completamente assemblato.

7. Riduzione di cilindro CO a formare un semicilindro HZ



49

È possibile assemblare un semicilindro da un cilindro Comfort AX o un cilindro a rotazione libera utilizzando un elemento centrale speciale.

- ✓ Estrattore per l'allentamento del morsetto
- ✓ Distanziatore per l'allineamento del bullone di prolunga
- ✓ Morsa di fissaggio per pressare il morsetto
- ✓ Elemento centrale semicilindro

- Posizionare il cilindro Comfort AX nell'attrezzo di montaggio del pomolo con il pomolo elettronico rivolto verso l'alto.



50

- Agganciare la punta dell'estrattore nel morsetto.



51

- Fare leva sul morsetto fuori dal cilindro profilato spostando l'estrattore al centro del cilindro.



52



NOTA

Lunghezza su testa bullone

Troverete un numero sulla testa del bullone. Questo numero è la lunghezza del profilo del cilindro per la quale è adatto il bullone.



27

- Rimettere insieme le due metà del cilindro.



28

- Il bullone è protetto dalla torsione.

- Estrarre di nuovo il distanziatore.



29

- Spingere le metà insieme completamente.



30

- Inserire di nuovo il morsetto con il naso rivolto verso la vite a risvolto nella fessura del cilindro profilato.



31

- Inserire il cilindro nella morsa di fissaggio in modo che il cilindro profilato e il pomolo siano a filo nelle cavità.



32

- La leva della morsa di fissaggio è rinforzata in un punto con una piastra metallica. Il morsetto inserito in precedenza si trova di fronte a questa piastra metallica.

- Spingere la leva della morsa di fissaggio verso la piastra di base fino a quando il morsetto è di nuovo completamente inserito nel cilindro profilato.



33

- Il cilindro AX è accorciato.

6. Combinazione di cilindro CO a formare un cilindro FD



34











È possibile formare un cilindro AX a rotazione libera combinando due cilindri AX Comfort.

- ✓ Estrattore per l'allentamento del morsetto
- ✓ Distanziatore per l'allineamento del bullone di prolunga
- ✓ Morsa di fissaggio per pressare il morsetto









- Posizionare il primo cilindro Comfort AX nell'attrezzo di montaggio del pomolo con il pomolo meccanico rivolto verso l'alto.







35

4. Estrarre completamente il morsetto dal cilindro profilato.
5. Separare le due metà del cilindro.
  53
 - ↳ Prima metà del cilindro preparata senza elemento centrale.
6. Posizionare il distanziatore sull'elemento centrale del semicilindro.
  54
7. Usando l'estrattore, avvitare un bullone di prolunga adatto fino a quando non poggia contro il distanziatore.
  55
8. Posizionare il semicilindro preparato nell'attrezzo di montaggio del pomolo.
  56
9. Posizionare l'elemento centrale del semicilindro sulla metà del cilindro preparato.
  57
 - ↳ Il bullone di prolunga è protetto dalla torsione.
10. Estrarre di nuovo il distanziatore.
  58
11. Spingere le parti del cilindro completamente insieme.
  59
12. Inserire di nuovo il morsetto con il naso rivolto verso la vite a risvolto nella fessura del cilindro profilato.
  60
13. Inserire il cilindro nella morsa di fissaggio in modo che il cilindro profilato e il pomolo siano a filo nelle cavità.
  61
 - ↳ La leva della morsa di fissaggio è rinforzata in un punto con una piastra metallica. Il morsetto inserito in precedenza si trova di fronte a questa piastra metallica.
14. Spingere la leva della morsa di fissaggio verso la piastra di base fino a quando il morsetto è di nuovo completamente inserito nel cilindro profilato.
  62
 - ↳ Il semicilindro AX è completamente assemblato.

8. Sostituzione del trascinatore.

- ✓ Disponibile estrattore per allentare il morsetto.
 - ✓ Disponibile distanziatore per allineare il bullone di prolunga.
 - ✓ Disponibile attrezzo idoneo per pressare il morsetto (ad es. morsettieria o chiave a tubo).
1. Introdurre il Digital Cylinder AX nell'attrezzo di montaggio del pomolo.
  63
 2. Agganciare la punta dell'estrattore nel morsetto.
  64
 3. Sollevare il morsetto dal cilindro profilato, spostando l'estrattore nel centro del cilindro.
  65
 4. Estrarre completamente il morsetto dal cilindro profilato.
  66
 5. Separare le due metà del cilindro.
  67
 6. Agganciare la punta dell'estrattore nel secondo morsetto.
  68
 7. Sollevare il secondo morsetto dal cilindro profilato, spostando l'estrattore nel centro del cilindro.
  69
 8. Estrarre completamente il secondo morsetto dal cilindro profilato.
  70





9. Svitare ed estrarre i due bulloni di prolunga.
  71
10. Rimuovere il trascinatore.
  72
11. Inserire un nuovo trascinatore.
  73
12. Posizionare il distanziatore.
  74
13. Avvitare con l'estrattore un bullone di prolunga idoneo fino a posizionarlo sul distanziatore.



NOTA

Lunghezza su testa bullone

Troverete un numero sulla testa del bullone. Questo numero è la lunghezza del profilo del cilindro per la quale è adatto il bullone.



-  75
 14. Applicare una metà del cilindro sul bullone di prolunga.
  76
 - ↳ Il bullone di prolunga è protetto contro la torsione.
 15. Estrarre il distanziatore.
  77
 16. Spingere le due metà fino a farle combaciare completamente.
  78
 17. Rimettere il morsetto con la sporgenza rivolta verso la vite di ritenuta nella fessura del cilindro profilato e premere con decisione il morsetto con il pollice, in modo che non possa cadere.
 18. Premere il morsetto con un attrezzo idoneo nel cilindro profilato (ad es. morsettieria o chiave a tubo).



NOTA

Morsettieria incompatibile con i trascinatori di ricambio

Alcuni trascinatori di ricambio non si adattano all'incavo della morsettieria. In caso di cilindri dotati di questo tipo di trascinatori non è possibile premere i morsetti nella morsettieria.





-  79
 19. Posizionare nuovamente il distanziatore.
  74
 20. Avvitare con l'estrattore un bullone di prolunga idoneo fino a posizionarlo sul distanziatore.



NOTA

Lunghezza su testa bullone

Troverete un numero sulla testa del bullone. Questo numero è la lunghezza del profilo del cilindro per la quale è adatto il bullone.

-  81
 21. Applicare una metà del cilindro sul bullone di prolunga.
 - ↳ Il bullone di prolunga è protetto contro la torsione. 82
 22. Estrarre il distanziatore.
  83
 23. Spingere le due metà fino a farle combaciare completamente.
  84

24. Rimettere il morsetto con la sporgenza rivolta verso la vite di ritenuta nella fessura del cilindro profilato e premere con decisione il morsetto con il pollice, in modo che non possa cadere.
25. Premere il morsetto con un attrezzo idoneo nel cilindro profilato (ad es. morsettiera o chiave a tubo).

**NOTA****Morsettiera incompatibile con i trascinatori di ricambio**

Alcuni trascinatori di ricambio non si adattano all'incavo della morsettiera. In caso di cilindri dotati di questo tipo di trascinatori non è possibile premere i morsetti nella morsettiera.



85

↳ Il trascinatore sul Digital Cylinder AX è stato sostituito.



86

9. Supporto e ulteriori informazioni

Materiale informativo/Documenti

<https://www.simons-voss.com/it/documenti.html>

<https://www.smartintego.com/int/home/infocenter/documentation>

Dichiarazioni di conformità

<https://www.simons-voss.com/it/certificati.html>

Supporto tecnico

+49 (0) 89 / 99 228 333

E-mail

support-simonsvoss@allegion.com

si-support-simonsvoss@allegion.com

FAQ

<https://faq.simons-voss.com/otrs/public.pl>

SimonsVoss Technologies GmbH, Feringastr. 4, D-85774 Unterfoehring, Germania

Indholdsfortegnelse

1.	Generelle sikkerhedshenvisninger.....	64
2.	Produktspecifikke sikkerhedsanvisninger	64
3.	Tilbehør og værktøj	64
3.1	Længdemodularitet	64
3.2	Medbringer	64
3.3	Værktøj	65
4.	Forlængelse af cylinder AX.....	65
5.	Afkortning af cylinder AX	65
6.	Kombination af CO-cylinder med FD	66
7.	Reducering af CO-cylinder til HZ	66
8.	Udskiftning af medbringer	66
9.	Hjælp og flere oplysninger	67

1. Generelle sikkerhedshenvisninger

Signalord: Mulige direkte virkninger i tilfælde af manglende overholdelse
ADVARSEL: Død eller alvorlig personskade (muligt, men usandsynligt) **OP-**
MÆRKSOMHED: Materiel skade eller fejlfunktion, **BEMÆRK:** Lidt eller ingen



ADVARSEL

Spærret adgang

Hvis komponenter er fejlagtigt monteret og/eller programmeret, kan adgang til en dør forblive spærret. For følgeskader, der skyldes spærret adgang, fx til personer, der er sårede eller i fare, tingsskader eller andre skader, hæfter SimonsVoss Technologies GmbH ikke!

Blokeret adgang gennem manipulation af produktet

Hvis du selv ændrer produktet, kan der opstå funktionsfejl, og adgang via en dør kan blokeres.

- ❑ Modificer kun produktet, når det er nødvendigt, og kun på den måde, der er beskrevet i dokumentationen.

OPMÆRKSOMHED

Beskadigelse på grund af væske

Dette produkt indeholder elektroniske og/eller mekaniske komponenter, som kan blive beskadiget på grund af alle typer væsker.

- ❑ Hold væsker væk fra elektronikken.

Beskadigelse på grund af aggressive rengøringsmidler

Produktets overflade kan blive beskadiget på grund af uegnede rengøringsmidler.

- ❑ Brug kun rengøringsmidler, der er velegnede til kunststof- og metaloverflader.



BEMÆRK

Korrekt anvendelse

SimonsVoss-produkter er kun beregnet til åbning og lukning af døre og sammenlignelige genstande.

- ❑ Anvend ikke SimonsVoss-produkter til andre formål.

Krævede kvalifikationer

Installation og idriftsættelse kræver specialiseret viden.

- ❑ Kun uddannet personale må installere og idriftsætte produktet.

Ændringer eller tekniske videreudviklinger kan ikke udelukkes og kan foretages uden forudgående varsel.

Den tyske sprogversion er den originale brugsanvisning. Andre sprog (udkast på kontrakt sproget) er oversættelser af de originale instruktioner.

Læs og følg alle installations-, installations- og idriftsættelsesinstruktioner. Overfør disse instruktioner og eventuel vedligeholdelsesinstruktion til brugeren.

2. Produktspecifikke sikkerhedsanvisninger



ADVARSEL

Fejlfunktion af antipanikfunktionen på grund af uautoriseret manipulation

Digital Cylinder AX har et indbygget antipanikmodul i antipanikversionen og er modular i længden i et begrænset omfang: Udvendig i alle længder, indvendig fra 50 mm og halvcylinder fra 50 mm.

1. Forsøg ikke at afmontere antipanikmodulet, da det ellers kan blive beskadiget.
2. Udfør en antipanikfunktionstest efter hver ændring.

3. Tilbehør og værktøj

3.1 Længdemodularitet

Profilcylindern kan forlænges og forkortes med følgende dele:

Forlængerbolt	Kerneudvidelse af profilen	Udvidelse af profil
 <ul style="list-style-type: none"> ❑ Z5.BOLT.XX (XX= ønsket basislængde) 	 <ul style="list-style-type: none"> ❑ Z5.CORE.05: 5 mm ❑ Z5.CORE.10: 10 mm ❑ Z5.CORE.20: 20 mm 	 <ul style="list-style-type: none"> ❑ Z5.PROFILE.05: 5 mm ❑ Z5.PROFILE.10: 10 mm ❑ Z5.PROFILE.20: 20 mm

Klips



- ❑ Z5.CLAMPS
- Et sæt indeholder 50 stk.

Midterstykke til cylinder



- ❑ Z5.CNT.EU

Midterstykke til halv cylinder



- ❑ Z5.CNT.HZ

Midterstykke til halv cylinder med multirast



- ❑ Z5.CNT.HZ.MR

Knopholder indvendig



- ❑ Z5.PR.IN

Blindprofil indvendigt uden knop



- Til variant .OK
- ❑ Z5.PR.OK

Knopholder til glasdørsknop





- Profillængde 30 mm (kan forlænges)
- ❑ Z5.PR.GD

3.2 Medbringere

Du har også mulighed for at vælge mellem forskellige medbringere:



Medbringere standard	Medbringere PMI (lang)	Medbringere PM2 (kort)
<ul style="list-style-type: none"> ❑ Z5.CAM.WP 	<ul style="list-style-type: none"> ❑ Z5.CAM.PM1 	<ul style="list-style-type: none"> ❑ Z5.CAM.PM2

Dobbelt medbringer	Medbringer-tandhjul med 10 tænder	Medbringer-tandhjul med 18 tænder
		
■ Z5.CAM.DOUBLE	■ Z5.CAM.GEAR10	■ Z5.GEAR.18

3.3 Værktøj

Til tilpasning af Digital Cylinder AX findes der forskellige værktøjer:

Løfter (Z5.LIFTER)	Afstandsholder (Z5.SPACER)	Klemmeblok (Z5.BLO-CK)
		

Knopmonteringsværktøjet til Digital Cylinder AX er designet, så du kan bruge den som holder for Digital Cylinder AX. Placér den på en flad overflade med den flade side nedad, og sæt Digital Cylinder AX med knoppen ind i monteringsværktøjet. Genmonteringen er lettere, hvis Digital Cylinder AX står i holderen.



2

4. Forlængelse af cylinder AX



3

Kerneforlængelsen og profilforlængelsen skal være lige lange. Derudover kræves en forlængerbolt til den ønskede længde.

- ✓ Løfter til løsning af klemme
- ✓ Afstandsholder til justering af forlængerbolt
- ✓ Klemmeblok til montering af klemme

1. Anbring cylinder AX i knopgreb-montageværktøjet.



4

2. Hægt løfterens spids ind i klemmen.



5

3. Lirk klemmen ud af profilylinderen ved at bevæge løfteren i midten af cylinderen.



6

4. Træk klemmen helt ud af profilylinderen.



7

5. Tag de to cylinderhalvdele fra hinanden.



8

6. Skru forlængerbolten ud med løfteren.



9

7. Montér den passende kerneforlængelse.

8. Montér den passende profilforlængelse.



10

9. Montér afstandsholderen.



11

10. Skru en passende forlængerbolt i med løfteren, indtil den støder imod afstandsholderen.



BEMÆRK

Længde på bolthoved

Der befinder sig et tal på bolthovedet. Dette tal er længden på cylinderprofilen, som boltten passer til.



12

11. Montér de to cylinderhalvdele igen.



13

↳ Forlængerbolten er beskyttet imod at dreje.

12. Træk afstandsholderen af igen.



14

13. Skub de to halvdele helt sammen.



15

14. Montér klemmen igen med spidsen imod cylindersikringskruen i profilylinderens slids, og tryk klemmen fast med tommelfingeren, så den ikke længere kan falde ud.



16

15. Montér cylinderen i klemmeblokken, så profilylinderen og knopgrebet flugter i udsparingerne.



17

↳ Klemmeblokkens arm er forstærket med en lille metalplade et sted. Den før indførte klemme ligger overfor denne lille metalplade.

16. Tryk klemmeblokkens arm imod bundpladen, indtil klemmen igen sidder helt i profilylinderen.



18

↳ Cylinder AX er forlængt.

5. Afkortning af cylinder AX



18

Der kræves en bolt til den ønskede længde.

- ✓ Løfter til løsning af klemme
- ✓ Afstandsholder til justering af bolt
- ✓ Klemmeblok til montering af klemme

1. Anbring cylinder AX i knopgreb-montageværktøjet.



19

2. Hægt løfterens spids ind i klemmen.



20

3. Lirk klemmen ud af profilylinderen ved at bevæge løfteren i midten af cylinderen.



21

4. Træk klemmen helt ud af profilylinderen.



22

5. Tag de to cylinderhalvdele fra hinanden.



23

6. Skru boltten ud med løfteren.



24

7. Fjern profilforlængelserne.

8. Fjern kerneforlængelserne.



25

9. Montér afstandsholderen.



26

10. Skru en passende bolt i med løfteren, indtil den støder imod afstandsholderen.



BEMÆRK

Længde på bolthoved

Der befinder sig et tal på bolthovedet. Dette tal er længden på cylinderprofilen, som boltten passer til.







27

11. Montér de to cylinderhalvdele igen.







28

- ↳ Bolten er beskyttet imod at dreje.
- 12. Træk afstandsholderen af igen.  29
- 13. Skub de to halvdele helt sammen.  30
- 14. Montér klemmen igen med spidsen imod cylindersikringsskruen i profilcylinderslids.  31
- 15. Montér cylinderen i klemmeblokken, så profilcylinderen og knopgrebet flugter i udsparingerne.  32
 - ↳ Klemmeblokkens arm er forstærket med en lille metalplade et sted. Den før indførte klemme ligger overfor denne lille metalplade.
- 16. Tryk klemmeblokkens arm imod bundpladen, indtil klemmen igen sidder helt i profilcylinderen.  33
- ↳ Cylinder AX er afkortet.

6. Kombination af CO-cylinder med FD

 34
En frit drejende cylinder AX kan sættes sammen af to AX-komfortcylindere.

- ✓ Løfter til løsning af klemme
- ✓ Afstandsholder til justering af forlængerbolt
- ✓ Klemmeblok til montering af klemme
- 1. Anbring den første komfortcylinder AX med det mekaniske knopgreb opad i knopgreb-montageværktøjet.  35
- 2. Hægt løfterens spids ind i klemmen.  36
- 3. Lirk klemmen ud af profilcylinderen ved at bevæge løfteren i midten af cylinderen.  37
- 4. Træk klemmen helt ud af profilcylinderen.  38
- 5. Tag de to cylinderhalvdele fra hinanden.  39
 - ↳ Første cylinderhalvdel forberedt med mellemstykke og medbringer.
- 6. Anbring den anden komfortcylinder AX med det elektroniske knopgreb opad i knopgreb-montageværktøjet.  40
- 7. Hægt løfterens spids ind i klemmen.  41
- 8. Lirk klemmen ud af profilcylinderen ved at bevæge løfteren i midten af cylinderen.  42
- 9. Træk klemmen helt ud af profilcylinderen.  43
- 10. Tag de to cylinderhalvdele fra hinanden.  44
 - ↳ Anden cylinderhalvdel forberedt uden mellemstykke.
- 11. Anbring den første cylinderhalvdel på den anden cylinderhalvdel.  45
- 12. Montér klemmen igen med spidsen imod cylindersikringsskruen i profilcylinderslids.  46
- 13. Montér cylinderen i klemmeblokken, så profilcylinderen og knopgrebet flugter i udsparingerne.  47

- ↳ Klemmeblokkens arm er forstærket med en lille metalplade et sted. Den før indførte klemme ligger overfor denne lille metalplade.
- 14. Tryk klemmeblokkens arm imod bundpladen, indtil klemmen igen sidder helt i profilcylinderen.  48
- ↳ Frit drejende cylinder færdigmonteret.

7. Reducering af CO-cylinder til HZ













 49

Med et specielt mellemstykke kan en halv cylinder sættes sammen af en AX-komfortcylinder eller en frit drejende cylinder.

- ✓ Løfter til løsning af klemme
- ✓ Afstandsholder til justering af forlængerbolt
- ✓ Klemmeblok til montering af klemme
- ✓ Halvcylinder-mellemstykke
- 1. Anbring cylinder AX med det elektroniske knopgreb opad i knopgreb-montageværktøjet.  50
- 2. Hægt løfterens spids ind i klemmen.  51
- 3. Lirk klemmen ud af profilcylinderen ved at bevæge løfteren i midten af cylinderen.  52
- 4. Træk klemmen helt ud af profilcylinderen.  53
- 5. Tag de to cylinderhalvdele fra hinanden.  54
 - ↳ Første cylinderhalvdel forberedt uden mellemstykke.
- 6. Montér afstandsholderen ved halvcylinder-mellemstykke.  55
- 7. Skru en passende forlængerbolt i med løfteren, indtil den støder imod afstandsholderen.  56
- 8. Anbring den forberedte cylinderhalvdel i knopgreb-montageværktøjet.  57
- 9. Anbring halvcylinder-mellemstykket på den forberedte cylinderhalvdel.  58
 - ↳ Forlængerbolten er beskyttet imod at dreje.
- 10. Træk afstandsholderen af igen.  59
- 11. Skub de to cylinderdele helt sammen.  60
- 12. Montér klemmen igen med spidsen imod cylindersikringsskruen i profilcylinderslids.  61
- 13. Montér cylinderen i klemmeblokken, så profilcylinderen og knopgrebet flugter i udsparingerne.  62
 - ↳ Klemmeblokkens arm er forstærket med en lille metalplade et sted. Den før indførte klemme ligger overfor denne lille metalplade.
- 14. Tryk klemmeblokkens arm imod bundpladen, indtil klemmen igen sidder helt i profilcylinderen.  63
- ↳ Halvcylinder AX er færdigmonteret.

8. Udskiftning af medbringer



- ✓ Løfter til løsning af klemme tilgængelig.
- ✓ Afstandsholder til justering af forlængerbolt tilgængelig.
- ✓ Værktøj til indpresning af klemmen (f.eks. en klemmeblok eller en montagetang) tilgængelig.

- Andbring Digital Cylinder AX i værktøjet til montering af knoppen.  63
- Hægt løfterens spids ind i klemmen.  64
- Lirk klemmen ud af profilcylinderen ved at bevæge løfteren i midten af cylinderen.  65
- Træk klemmen helt ud af profilcylinderen.  66
- Tag de to cylinderhalvdele fra hinanden.  67
- Hægt løfterens spids ind i den anden klemme.  68
- Løft den anden klemme ud af profilcylinderen ved at bevæge løfteren til midten af cylinderen.  69
- Træk den anden klemme helt ud af profilcylinderen.  70
- Skrub begge forlængerbolte af.  71
- Fjern medbringeren.  72
- Sæt en ny medbringer i.  73
- Montér afstandsholderen.  74
- Skrub en passende forlængerbolt i med løfteren, indtil den hviler mod afstandsholderen.

**BEMÆRK****Længde på bolthoved**

Der befinder sig et tal på bolthovedet. Dette tal er længden på cylinderprofilen, som boltten passer til.



- Skub den ene halvdel af cylinderen på forlængerboltten.  76
- Træk afstandsholderen af igen.  77
- Skub de to halvdele helt sammen.  78
- Montér klemmen igen med spidsen mod cylindersikringskruen i profilcylinderens slids, og tryk klemmen fast med tommelfingeren så den ikke kan falde ud.
- Tryk klemmen ind i profilcylinderen med et passende værktøj (f.eks. klemmeblok eller montagetang).

**BEMÆRK****Klemmeblok inkompatibel med udskiftnings-medbringerne**

Nogle udskiftnings-medbringerer passer ikke ind i fordybningen i klemmeblokken. På cylindre med disse medbringerer kan klemmerne ikke trykkes ind med klemmeblokken.





- Placér afstandsholderen igen.  74
- Skrub en passende forlængerbolt i med løfteren, indtil den hviler mod afstandsholderen.

**BEMÆRK****Længde på bolthoved**

Der befinder sig et tal på bolthovedet. Dette tal er længden på cylinderprofilen, som boltten passer til.



- Skub den ene halvdel af cylinderen på forlængerboltten.  82
- Træk afstandsholderen af igen.  83
- Skub de to halvdele helt sammen.  84
- Montér klemmen igen med spidsen mod cylindersikringskruen i profilcylinderens slids, og tryk klemmen fast med tommelfingeren så den ikke kan falde ud.
- Tryk klemmen ind i profilcylinderen med et passende værktøj (f.eks. klemmeblok eller montagetang).

**BEMÆRK****Klemmeblok inkompatibel med udskiftnings-medbringerne**

Nogle udskiftnings-medbringerer passer ikke ind i fordybningen i klemmeblokken. På cylindre med disse medbringerer kan klemmerne ikke trykkes ind med klemmeblokken.



- Medbringeren på Digital Cylinder AX er nu udskiftet.



9. Hjælp og flere oplysninger

Infomateriale/dokumenter

<https://www.simons-voss.com/dk/dokumenter.html>

<https://www.smartintego.com/int/home/infocenter/documentation>

Overensstemmelseserklæringer

<https://www.simons-voss.com/dk/certifikater.html>

Teknisk support

+49 (0) 89 / 99 228 333

e-mail

support-simonsvoss@allegion.com

si-support-simonsvoss@allegion.com

FAQ

<https://faq.simons-voss.com/otrs/public.pl>

SimonsVoss Technologies GmbH, Feringastr. 4, D-85774 Unterföhring, Tyskland

Innehållsförteckning

1.	Allmänna säkerhetsanvisningar	69
2.	Produktspecifika säkerhetsanvisningar	69
3.	Tillbehör och verktyg	69
3.1	Längdmodularitet.....	69
3.2	Medbringare	69
3.3	Verktyg.....	70
4.	Förlänga Cylinder AX.....	70
5.	Förkorta Cylinder AX.....	70
6.	Kombinera CO-cylindrar till FD	71
7.	Reducera CO-cylinder till HZ	71
8.	Byta medbringare	72
9.	Hjälp och ytterligare information.....	72

1. Allmänna säkerhetsanvisningar

Signalord: *Eventuella omedelbara effekter av bristande efterlevnad*

WARNING: Död eller allvarlig skada (möjligt, men osannolikt)OBS: Skador på egendom eller fel. INFO: Låg eller ingen



WARNING

Tillgång spärrad

Felaktigt installerade och/eller programmerade komponenter kan leda till att dörrar spärras. SimonsVoss Technologies GmbH ansvarar inte för konsekvenserna av felaktig installation såsom spärrat tillträde till skadade personer eller personer i risksituationer, materiella skador eller andra typer av skador.

Blockerad åtkomst genom manipulering av produkten

Om du ändrar produkten på egen hand kan fel uppstå och åtkomst via en dörr kan blockeras.

- Ändra endast produkten vid behov och endast på det sätt som beskrivs i dokumentationen.

OBS

Skada på grund av vätskor

Den här produkten innehåller elektroniska och/eller mekaniska komponenter som kan skadas av alla typer av vätskor.

- Låt inte elektroniken komma i kontakt med vätskor.

Skada på grund av aggressiva rengöringsmedel

Ytan på den här produkten kan skadas om olämpliga rengöringsmedel används.

- Använd endast rengöringsmedel som lämpar sig för plast- och metalltor.



INFO

Avsedd användning

SimonsVoss-produkter är uteslutande avsedda för öppning och stängning av dörrar och liknande.

- Använd inte SimonsVoss-produkter för andra syften.

Kvalifikationer krävs

Installation och idrifttagning kräver specialiserad kunskap.

- Endast utbildad personal får installera och driftsätta produkten.

Ändringar eller teknisk vidareutveckling kan inte uteslutas och kan komma att genomföras utan föregående meddelande om detta.

Den tyska språkversionen är den ursprungliga bruksanvisningen. Andra språk (utarbetande på kontraktsspråket) är översättningar av originalinstruktionerna.

Läs och följ alla installations-, installations- och driftsinstruktioner. Skicka dessa instruktioner och alla underhållsinstruktioner till användaren.

2. Produktspecifika säkerhetsanvisningar



WARNING

Störning i antipanikfunktionen på grund av ootillåten manipulation

Digital Cylinder AX har en fast monterad antipanikmodul i antipanikvarianten och är längdmodulärt begränsad: Utsida valfritt, insida från 50 mm och halvcylinder från 50 mm.

1. Försök inte demontera antipanikmodulen eftersom den då kan skadas.
2. Genomför ett antipanikfunktionstest efter varje ombyggnad.

3. Tillbehör och verktyg

3.1 Längdmodularitet

Profilcylindern kan förlängas och förkortas med följande delar:

Förlängningsbult	Kärnförlängning av profilen	Profilförlängning
 <ul style="list-style-type: none"> ■ Z5.BOLT.XX (XX=önskad grundlängd) 	 <ul style="list-style-type: none"> ■ Z5.CORE.05: 5 mm ■ Z5.CORE.10: 10 mm ■ Z5.CORE.20: 20 mm 	 <ul style="list-style-type: none"> ■ Z5.PROFILE.05: 5 mm ■ Z5.PROFILE.10: 10 mm ■ Z5.PROFILE.20: 20 mm

Klämma



- Z5.CLAMPS



En sats innehåller 50 stycken.



Cylindermellanstycke	Halvcylindermellanstycke	Halvcylindermellanstycke med multipårr
 <ul style="list-style-type: none"> ■ Z5.CNT.EU 	 <ul style="list-style-type: none"> ■ Z5.CNT.HZ 	 <ul style="list-style-type: none"> ■ Z5.CNT.HZ.MR

Knoppfäste insida	Blindprofil insida utan knopp	Knoppfäste för glasdörrknopp
 <ul style="list-style-type: none"> ■ Z5.PR.IN 	 <ul style="list-style-type: none"> För variant .OK ■ Z5.PR.OK 	 <ul style="list-style-type: none"> Profilförlängd 30 mm (förlängningsbar) ■ Z5.PR.GD

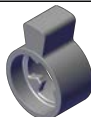
3.2 Medbringare



Det finns dessutom olika medbringare att välja mellan:

Medbringare standard	Medbringare PM1 (lång)	Medbringare PM2 (kort)
 <ul style="list-style-type: none"> ■ Z5.CAM.WP 	 <ul style="list-style-type: none"> ■ Z5.CAM.PM1 	 <ul style="list-style-type: none"> ■ Z5.CAM.PM2

Dubbelmedbringare	Medbringare kuggjul 10 kuggar	Medbringare kuggjul 18 kuggar
		
■ Z5.CAM.DOUBLE	■ Z5.CAM.GEAR10	■ Z5.GEAR.18

3.3 Verktyg

Det finns olika verktyg tillgängliga för anpassning av Digital Cylinder AX:

Lyftdon (Z5.LIFTER)	Distanshållare (Z5.SPACER)	Klämblock (Z5.BLOCK)
		

Knoppmonteringsverktyget till Digital Cylinder AX är konstruerat så att det kan användas som hållare för Digital Cylinder AX. Lägg det med den platta sidan på en plan yta och placera Digital Cylinder AX med knoppen i monteringsverktyget. Återmonteringen går lättare om Digital Cylinder AX står i hållaren.



2

4. Förlänga Cylinder AX



3

Kärnförlängningen och profölförlängningen måste vara lika långa. Dessutom behöver du en förlängningsbult för den önskade längden.

- ✓ Lyftdon för lossning av klämma
- ✓ Distanshållare för inriktning av förlängningsbulten
- ✓ Klämblock för inpressning av klämma

1. Placera Cylinder AX i knoppmonteringsverktyget.



4

2. Haka i lyftdonet i klämman.



5

3. Lyft klämman ur profilylindern genom att röra lyftdonet i cylinderns mitt.



6

4. Dra ut klämman helt ur profilylindern.



7

5. Ta isär de båda cylinderhalvorna.



8

6. Skruva ur förlängningsbulten med lyftdonet.



9

7. Sätt i passande kärnförlängningar.

8. Sätt på passande profölförlängningar.



10

9. Lägg på distanshållaren.



11

10. Skruva in en passande förlängningsbult med lyftdonet så att den ligger an mot distanshållaren.



INFO

Längd på bulthuvudet

På bulthuvudet är en siffra angiven. Denna siffra anger längden på cylinderprofilen till vilken bulten passar.



12

11. Sätt samman de båda cylinderhalvorna igen.



13

- ↳ Förlängningsbulten är skyddad mot att vridas.

12. Dra av distanshållaren igen.



14

13. Skjut samman halvorna helt.



15

14. Sätt tillbaka klämman med den utskjutande delen mot cylinderskruven i profilylinderns ursparning och tryck fast klämman med tummen så att den inte kan lossna.



16

15. Sätt in cylindern i klämblocket så att profilylindern och knoppen ligger plant i ursparningen.



17

- ↳ Spaken på klämblockets spak mot bottenplattan på ett ställe. Den tidigare inskjutna klämman ligger mitt emot denna metallplatta.

16. Tryck klämblockets spak mot bottenplattan så att klämman åter sitter fullständigt i profilylindern.



- ↳ Cylinder AX är förlängd.

5. Förkorta Cylinder AX



18

Du behöver en förlängningsbult för den önskade längden.

- ✓ Lyftdon för lossning av klämma
- ✓ Distanshållare för inriktning av bulten
- ✓ Klämblock för inpressning av klämma

1. Placera Cylinder AX i knoppmonteringsverktyget.



19

2. Haka i lyftdonet i klämman.



20

3. Lyft klämman ur profilylindern genom att röra lyftdonet i cylinderns mitt.



21

4. Dra ut klämman helt ur profilylindern.



22

5. Ta isär de båda cylinderhalvorna.



23

6. Skruva ur bulten med lyftdonet.



24

7. Avlägsna profölförlängningarna.

8. Avlägsna kärnförlängningarna.



25

9. Lägg på distanshållaren.



26

10. Skruva in en passande bult med lyftdonet så att den ligger an mot distanshållaren.









INFO

Längd på bulthuvudet

På bulthuvudet är en siffra angiven. Denna siffra anger längden på cylinderprofilen till vilken bulten passar.













27



11. Sätt samman de båda cylinderhalvorna igen.
 -  28
 - ↳ Bulten är skyddad mot att vridas.
12. Dra av distanshållaren igen.
 -  29
13. Skjut samman halvorna helt.
 -  30
14. Sätt tillbaka klämman med den utskjutande delen mot cylinderskraven i profilycylindrens ursparning.
 -  31
15. Sätt in cylindern i klämblocket så att profilycylindern och knoppen ligger plant i ursparningen.
 -  32
 - ↳ Spaken på klämblocket är förstärkt med en liten metallplatta på ett ställe. Den tidigare inskjutna klämman ligger mitt emot denna metallplatta.
16. Tryck klämblockets spak mot bottenplattan så att klämman åter sitter fullständigt i profilycylindern.
 -  33
 - ↳ Cylinder AX är förkortad.

6. Kombinera CO-cylindrar till FD



Du kan sätta samman en friroterande Cylinder AX av två AX-Comfortcylindrar.













- ✓ Lyftdon för lossning av klämman
 - ✓ Distanshållare för inriktning av förlängningsbulten
 - ✓ Klämblock för inpressning av klämman
1. Placera den första Comfortcylinder AX med den mekaniska knoppen uppåt i knoppmonteringsverktyget.
 -  35
 2. Haka i lyftdonet i klämman.
 -  36
 3. Lyft klämman ur profilycylindern genom att röra lyftdonet i cylinderns mitt.
 -  37
 4. Dra ut klämman helt ur profilycylindern.
 -  38
 5. Ta isär de båda cylinderhalvorna.
 -  39
 - ↳ Första cylinder halvan förberedd med mellanstycke och medbringarbit.
 6. Placera den andra Comfortcylinder AX med den elektroniska knoppen uppåt i knoppmonteringsverktyget.
 -  40
 7. Haka i lyftdonet i klämman.
 -  41
 8. Lyft klämman ur profilycylindern genom att röra lyftdonet i cylinderns mitt.
 -  42
 9. Dra ut klämman helt ur profilycylindern.
 -  43
 10. Ta isär de båda cylinderhalvorna.
 -  44
 - ↳ Andra cylinderhalvan förberedd utan mellanstycke.
 11. Sätt den första cylinderhalvan på den andra cylinderhalvan.
 -  45

12. Sätt tillbaka klämman med den utskjutande delen mot cylinderskraven i profilycylindrens ursparning.
 -  46
13. Sätt in cylindern i klämblocket så att profilycylindern och knoppen ligger plant i ursparningen.
 -  47
 - ↳ Spaken på klämblocket är förstärkt med en liten metallplatta på ett ställe. Den tidigare inskjutna klämman ligger mitt emot denna metallplatta.
14. Tryck klämblockets spak mot bottenplattan så att klämman åter sitter fullständigt i profilycylindern.
 -  48
 - ↳ Friroterande cylinder sammansatt.

7. Reducera CO-cylinder till HZ



Du kan sätta samman en halv cylinder av en AX-Comfortcylinder eller en friroterande cylinder med ett speciellt mellanstycke.

- ✓ Lyftdon för lossning av klämman
 - ✓ Distanshållare för inriktning av förlängningsbulten
 - ✓ Klämblock för inpressning av klämman
 - ✓ Halvcylindermellanstycke
1. Placera Cylinder AX med den elektroniska knoppen uppåt i knoppmonteringsverktyget.
 -  50
 2. Haka i lyftdonet i klämman.
 -  51
 3. Lyft klämman ur profilycylindern genom att röra lyftdonet i cylinderns mitt.
 -  52
 4. Dra ut klämman helt ur profilycylindern.
 5. Ta isär de båda cylinderhalvorna.
 -  53
 - ↳ Första cylinderhalvan förberedd utan mellanstycke.
 6. Lägg på distanshållaren på halvcylindermellanstycket.
 -  54
 7. Skruva in en passande förlängningsbult med lyftdonet så att den ligger an mot distanshållaren.
 -  55
 8. Placera den förberedda cylinderhalvan i knoppmonteringsverktyget.
 -  56
 9. Placera halvcylindermellanstycket i knoppmonteringsverktyget.
 -  57
 - ↳ Förlängningsbulten är skyddad mot att vridas.
 10. Dra av distanshållaren igen.
 -  58
 11. Skjut samman cylinderalarna helt.
 -  59
 12. Sätt tillbaka klämman med den utskjutande delen mot cylinderskraven i profilycylindrens ursparning.
 -  60
 13. Sätt in cylindern i klämblocket så att profilycylindern och knoppen ligger plant i ursparningen.
 -  61
 - ↳ Spaken på klämblocket är förstärkt med en liten metallplatta på ett ställe. Den tidigare inskjutna klämman ligger mitt emot denna metallplatta.

- Tryck klämblockets spak mot bottenplattan så att klämman åter sitter fullständigt i profilylindern.



62

- Halvcylinder AX är sammansatt.

8. Byta medbringare

- ✓ Lyftdon för lossning av klämman finns.
- ✓ Distanshållare för inriktning av förlängningsbulten finns.
- ✓ Lämpligt verktyg för inpressning av klämman (till exempel klämblock eller armaturtång) finns.

- Placera Digital Cylinder AX i knoppmonteringsverktyget.



63

- Haka i lyftdonet i klämman.



64

- Lyft klämman ur profilylindern genom att röra lyftdonet i cylinderns mitt.



65

- Dra ut klämman helt ur profilylindern.



66

- Ta isär de båda cylinderhalvorna.



67

- Haka i lyftdonets spets i den andra klämman.



68

- Lyft den andra klämman ur profilylindern genom att röra lyftdonet i cylinderns mitt.



69

- Dra ut den andra klämman helt ur profilylindern.



70

- Skruva ur de båda förlängningsbultarna.



71

- Avlägsna medbringaren.



72

- Sätt i en ny medbringare.



73

- Lägg på distanshållaren.



74

- Skruva in en passende förlängningsbult med lyftdonet så att den ligger an mot distanshållaren.



INFO

Längd på bulthuvudet

På bulthuvudet är en siffra angiven. Denna siffra anger längden på cylinderprofilen till vilken bulten passar.



75

- Sätt en cylinderhalva på förlängningsbulten.



76

- ⚠ Förlängningsbulten är skyddad mot att vridas.

- Dra av distanshållaren igen.



77

- Skjut samman halvorna helt.



78

- Sätt tillbaka klämman med den utskjutande delen mot cylinderskraven i profilylinderns ursparning och tryck fast klämman med tummen så att den inte kan lossna.

- Pressa in klämman i profilylinder med ett lämpligt verktyg (till exempel klämblock eller armaturtång).



INFO

Klämblock med utbytesmedbringare ej kompatibel

Vissa utbytesmedbringare passar inte i ursparningen på klämblocket. Klämmorna kan inte pressas in i med klämblocket hos cylindrar med dessa medbringare.



79

- Lägg på distanshållaren igen.



74

- Skruva in en passende förlängningsbult med lyftdonet så att den ligger an mot distanshållaren.



INFO

Längd på bulthuvudet

På bulthuvudet är en siffra angiven. Denna siffra anger längden på cylinderprofilen till vilken bulten passar.



81

- Sätt en cylinderhalva på förlängningsbulten.

- ⚠ Förlängningsbulten är skyddad mot att vridas.



82

- Dra av distanshållaren igen.



83

- Skjut samman halvorna helt.



84

- Sätt tillbaka klämman med den utskjutande delen mot cylinderskraven i profilylinderns ursparning och tryck fast klämman med tummen så att den inte kan lossna.

- Pressa in klämman i profilylinder med ett lämpligt verktyg (till exempel klämblock eller armaturtång).



INFO

Klämblock med utbytesmedbringare ej kompatibel

Vissa utbytesmedbringare passar inte i ursparningen på klämblocket. Klämmorna kan inte pressas in i med klämblocket hos cylindrar med dessa medbringare.



85

- ⚠ Medbringaren på Digital Cylinder AX har bytts ut.



86

9. Hjälp och ytterligare information

Infomaterial/dokument

<https://www.simons-voss.com/se/dokument.html>

<https://www.smartintego.com/int/home/infocenter/documentation>

Försäkringar om överensstämmelse

<https://www.simons-voss.com/se/certifikat.html>

Teknisk support

+49 (0) 89 / 99 228 333

support-simonsvoss@allegion.com

si-support-simonsvoss@allegion.com

FAQ

<https://faq.simons-voss.com/otrs/public.pl>

SimonsVoss Technologies GmbH, Feringastr. 4, D-85774 Unterföhring, Tyskland



This is SimonsVoss

SimonsVoss, the pioneer in remote-controlled, cable-free locking technology provides system solutions with a wide range of products for SOHOs, SMEs, major companies and public institutions. SimonsVoss locking systems combine intelligent functionality, high quality and award-winning design Made in Germany.

As an innovative system provider, SimonsVoss focuses on scalable systems, high security, reliable components, powerful software and simple operation. As such, SimonsVoss is regarded as a technology leader in digital locking systems. Our commercial success lies in the courage to innovate, sustainable thinking and action, and heartfelt appreciation of employees and partners.

SimonsVoss is a company in the ALLEGION Group, a globally active network in the security sector. Allegion is represented in

around 130 countries worldwide (www.allegion.com).

Made in Germany

SimonsVoss is truly committed to Germany as a manufacturing location: all products are developed and produced exclusively in Germany.

© 2024, SimonsVoss Technologies GmbH, Unterföhring

All rights are reserved. Text, images and diagrams are protected under copyright law.

The content of this document must not be copied, distributed or modified. You can find more information on our website. Subject to technical changes.

SimonsVoss and MobileKey are registered brands belonging to SimonsVoss.

SimonsVoss
technologies

Made in Germany

A BRAND OF

