



Simons  Voss

DE Kurzanleitung
EN Quick Guide
FR Guide abrégé
NL Korte handleiding
IT Guida breve
DK Kort vejledning
SE Snabbguide

BS21.990604
08.03.2024

Digital SmartHandle AX Metal frame

Simons  Voss
technologies

Abbildungen/Images	3
deutsch	25
english	30
français	34
nederlands	39
italiano	44
dansk	49
svensk	53

5. Design

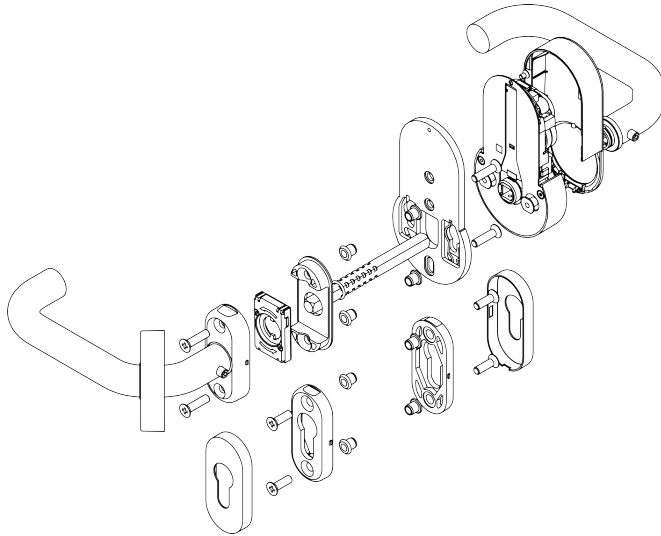

Inside

Outside

6. Prepare door (drilling template)



PH2

Ø7.2

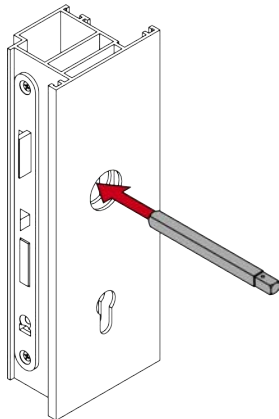



3

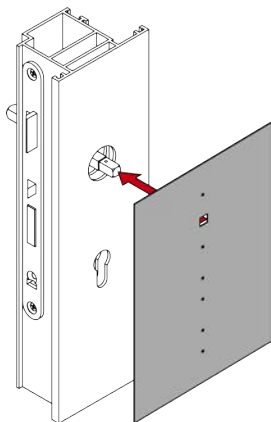

4

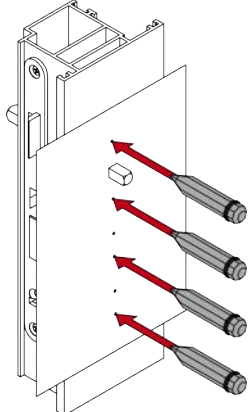

5

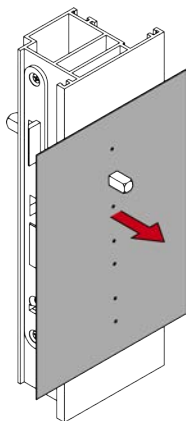

6

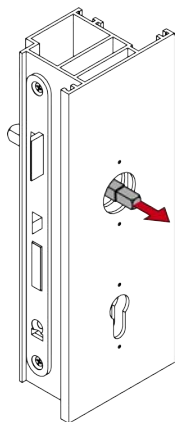

7



PH2

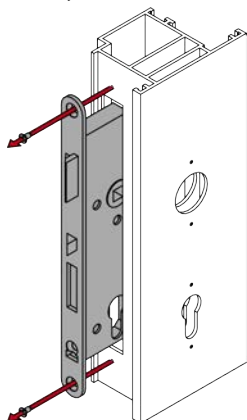

8



Ø7.2

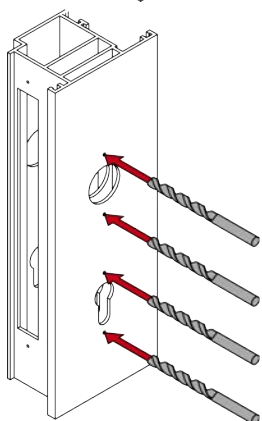

9

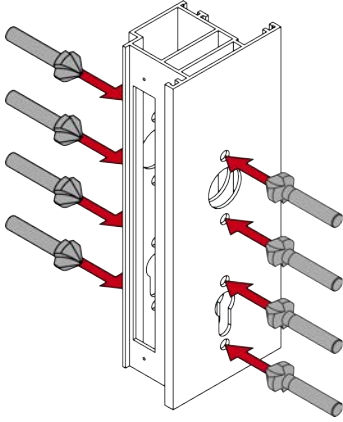

10



PH2

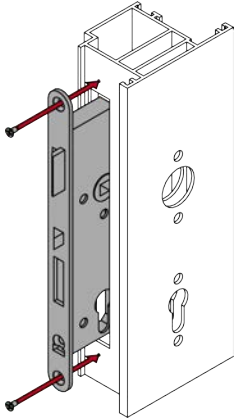

7. For door thickness X: prepare spindle



11

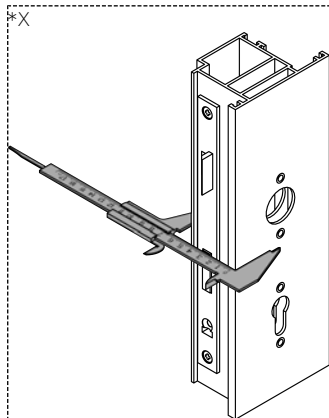

12

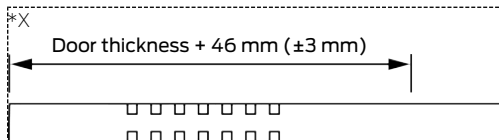

13

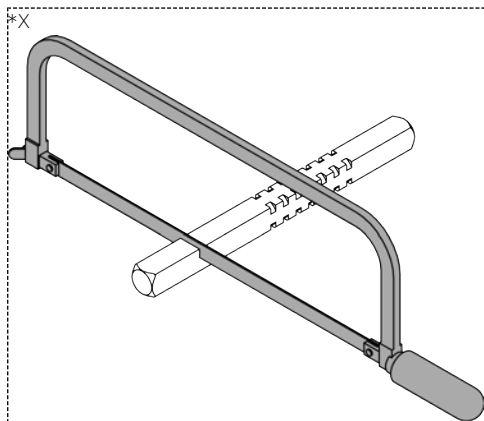

8. Programming the fitting

 14

*System3060

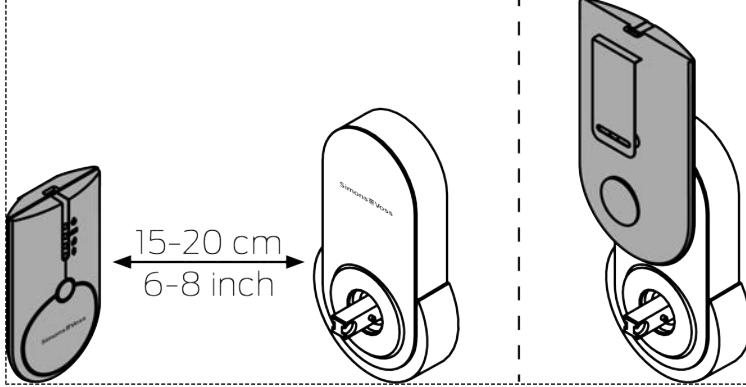

 15

*SI-WO

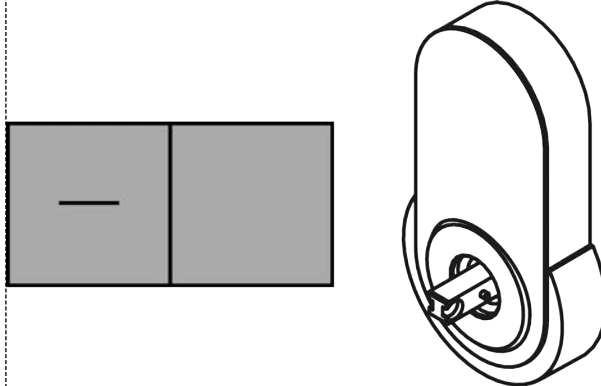

 16

*SI-VCN

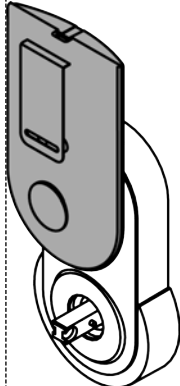

9. Installing the fitting



PH2

PH1

TX15

17

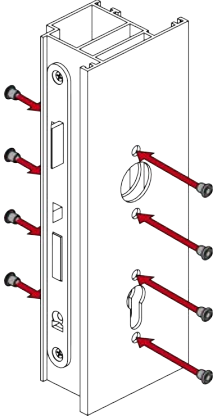

18



PH2



1.1 Nm
±10%

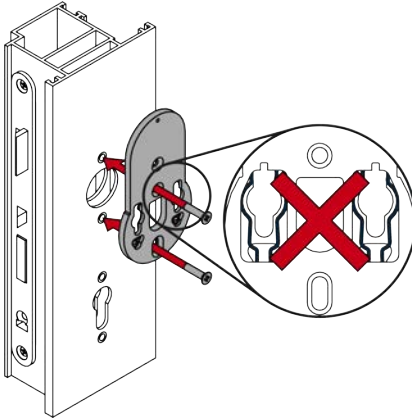

19



PH2



1.1 Nm
±10%

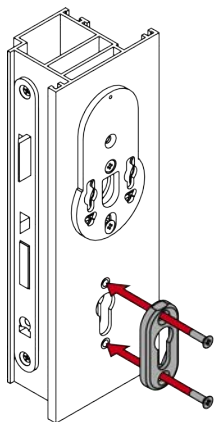

20

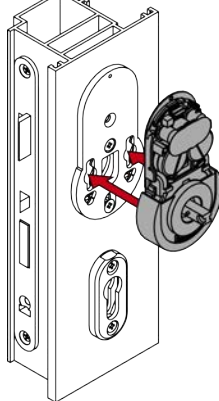

21

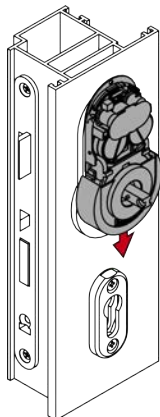

22



PH1



0.8 Nm
±10%

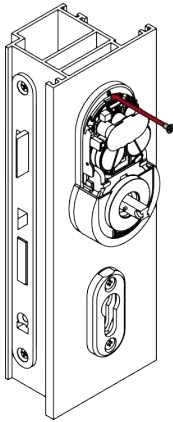

23

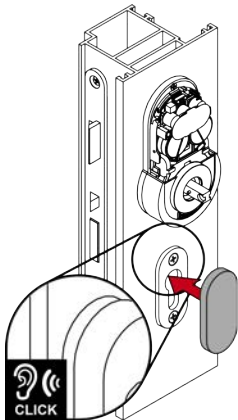

24

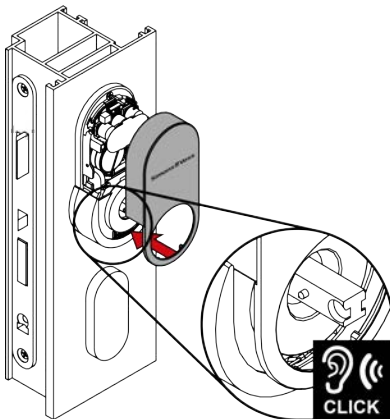

25

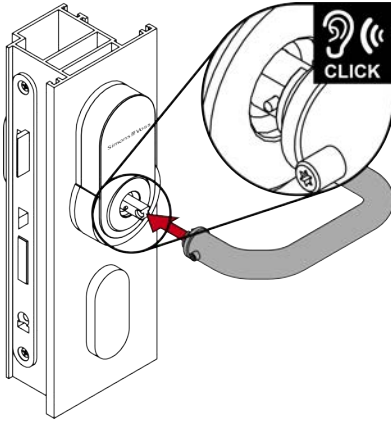

26

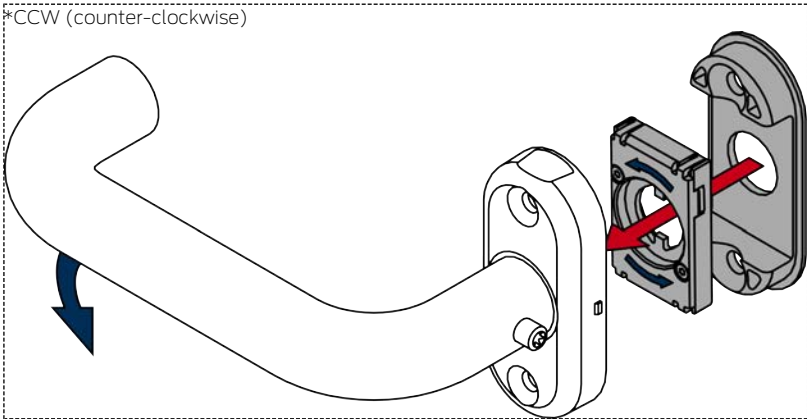

27

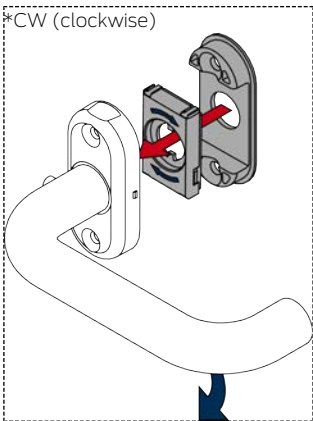

28

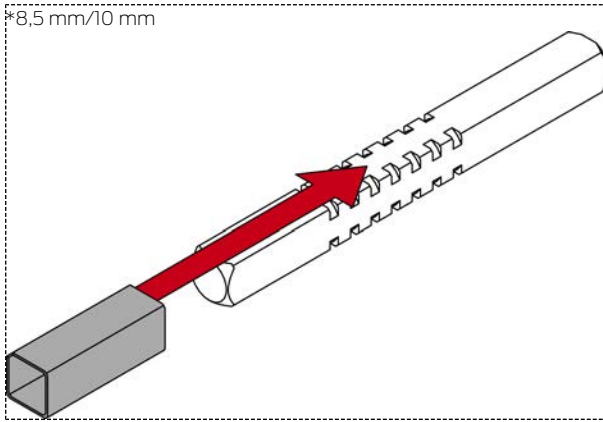

29

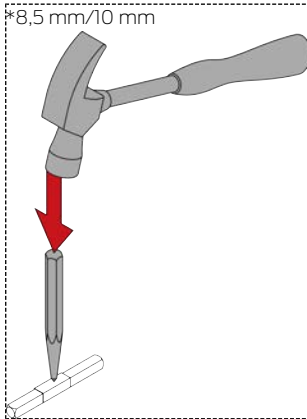

30

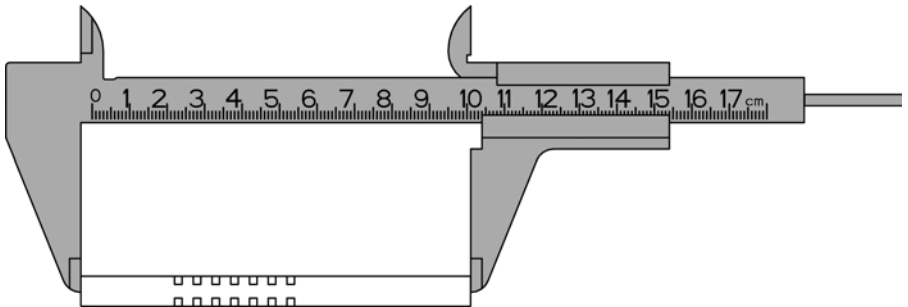

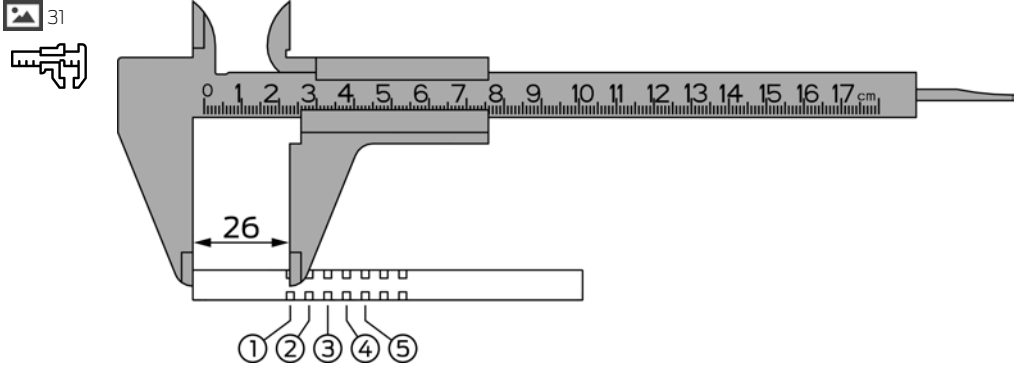

Area	Door thickness (mm)	Spindle length (mm)	Ring position
S	40 - 42	94	3
S	40 - 42	104	5
S	43 - 47	94	2
S	43 - 47	104	4
S	48 - 52	94	1
S	48 - 52	104	3
S	53 - 57	104	2
S	58 - 61	104	1
M	60 - 62	114	3
M	60 - 62	124	5
M	63 - 67	114	2
M	63 - 67	124	4
M	68 - 72	114	1
M	68 - 72	124	3
M	73 - 77	124	2
M	78 - 81	124	1
L	80 - 82	134	3
L	80 - 82	144	5
L	83 - 87	134	2
L	83 - 87	144	4
L	88 - 92	134	1
L	88 - 92	144	3
L	93 - 97	144	2
L	98 - 101	144	1
XL	100 - 184	O-ring is 30–35 mm from the cut end of the spindle.	

 32

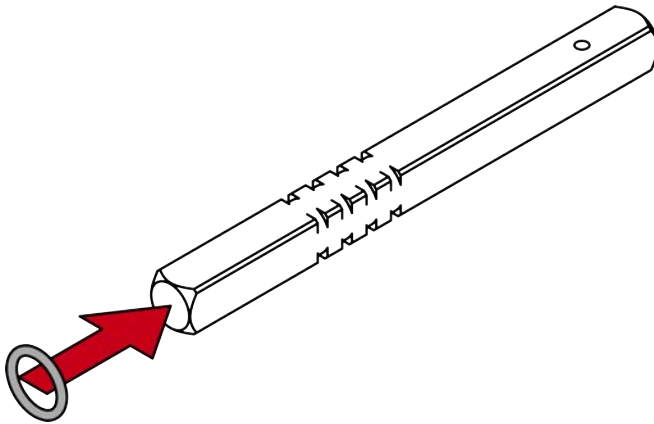

 33

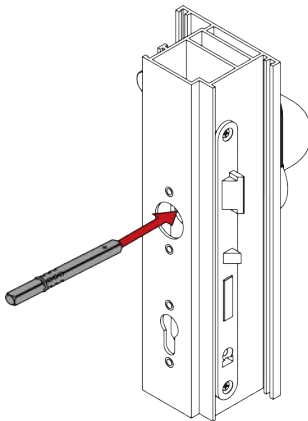

 34

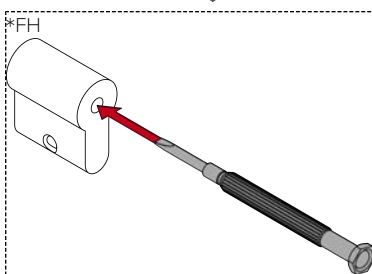

 35

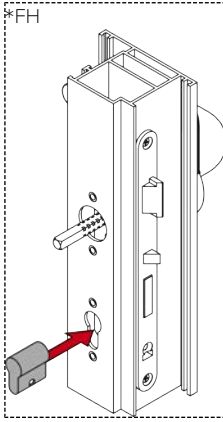

 36



PH2



1.1 Nm
±10%

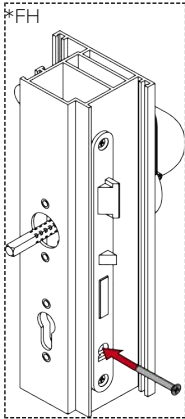

 37



PH2



1.1 Nm
±10%

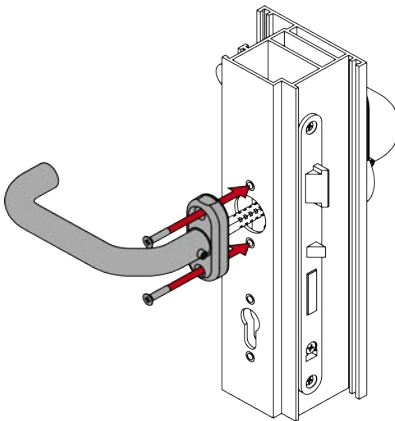

 38



PH2



1.1 Nm
±10%

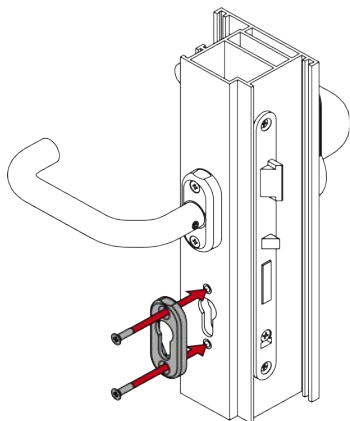

 39



TX15



5.0 Nm
±20%

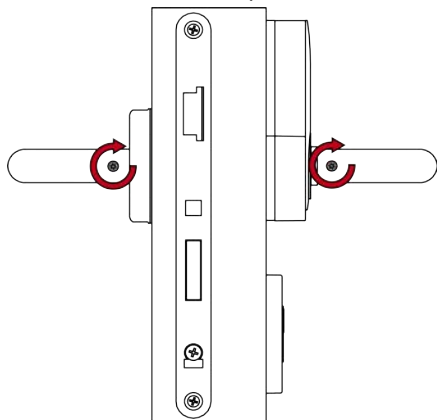

 40

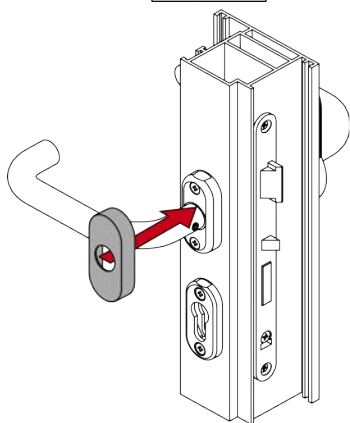

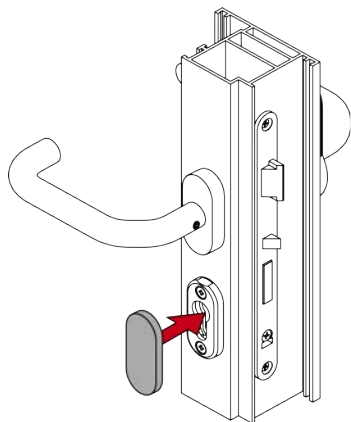

10. Removing the fitting



SW1.5



SW1.5

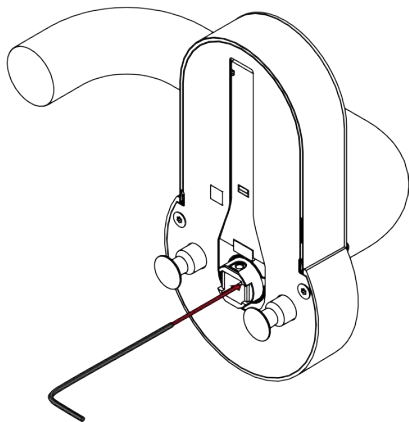

43



SW1.5

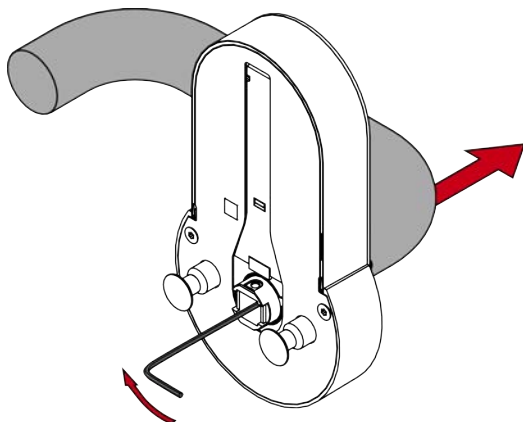

11. Replacing the batteries



44

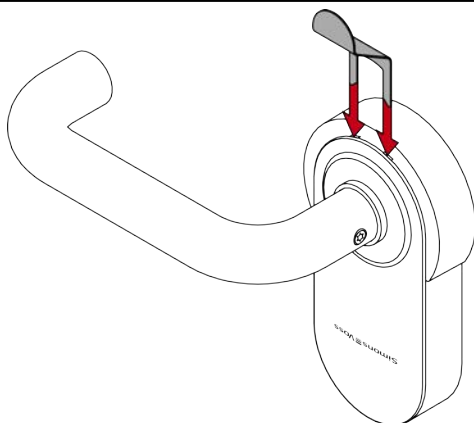

 45

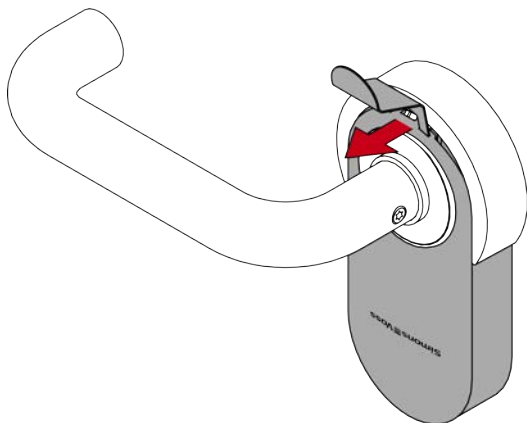

 46

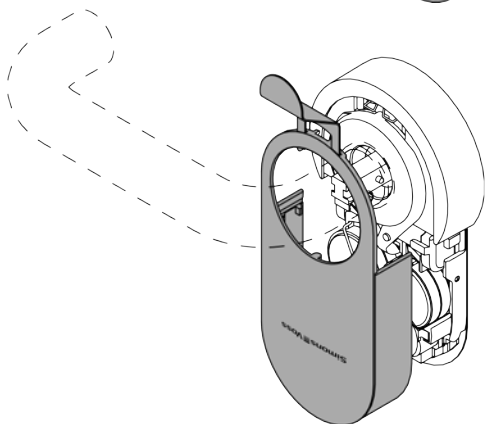

 47

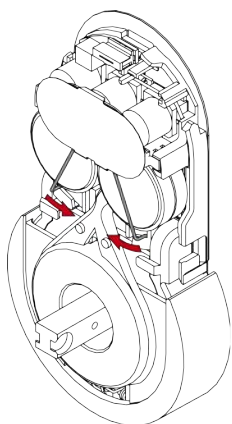

 48

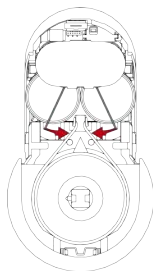

 49

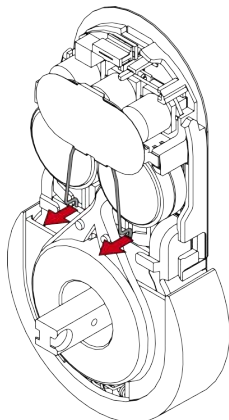

 50

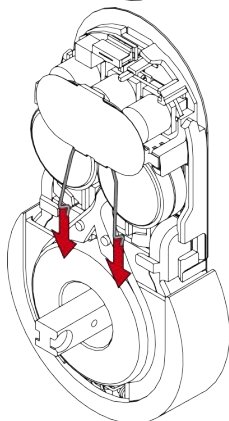

 51

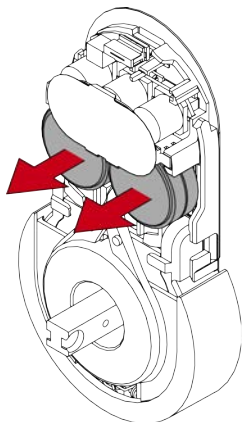

 52

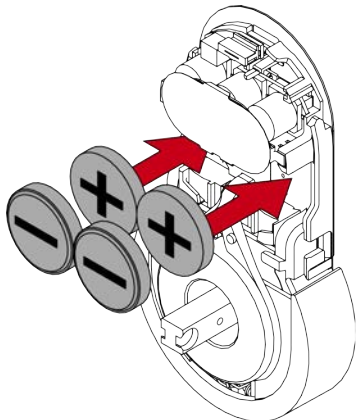

 53

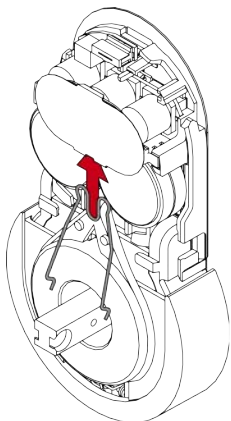

 54

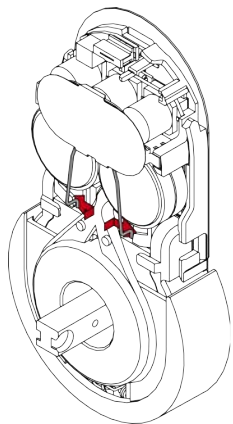

 55

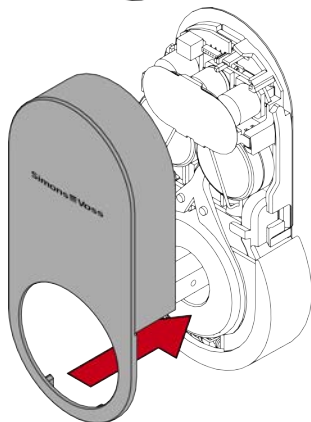

 56

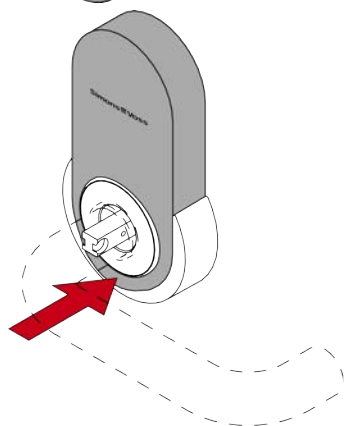

14. Help and other information



57



1. Bestimmungsgemäßer Gebrauch

Bei den Produkten der SmartHandle AX-Serie handelt es sich um elektronische Türbeschläge. Mithilfe eines berechtigten Identifikationsmediums kann das SmartHandle AX einkuppeln und die entsprechende Tür öffnen.

Entsprechende Berechtigungen müssen mit Hilfe eines elektronischen Schließplans erteilt werden.

Produkte der SmartHandle AX-Serie dürfen nur für das Öffnen und Schließen von Türen genutzt werden. Ein anderer Gebrauch ist nicht zulässig.

2. Allgemeine Sicherheitshinweise

Signalwort: Mögliche unmittelbare Auswirkungen bei Nichtbeachtung

WARNUNG: Tod oder schwere Verletzung (möglich, aber unwahrscheinlich), **VORSICHT:** Leichte Verletzung, **ACHTUNG:** Sachschäden oder Fehlfunktionen, **HINWEIS:** Geringe oder keine



WARNUNG

Versperrter Zugang

Durch fehlerhaft montierte und/oder programmierte Komponenten kann der Zutritt durch eine Tür versperrt bleiben. Für Folgen eines versperrten Zutritts wie Zugang zu verletzten oder gefährdeten Personen, Sachschäden oder anderen Schäden haftet die SimonsVoss Technologies GmbH nicht!

Versperrter Zugang durch Manipulation des Produkts

Wenn Sie das Produkt eigenmächtig verändern, dann können Fehlfunktionen auftreten und der Zugang durch eine Tür versperrt werden.

- Verändern Sie das Produkt nur bei Bedarf und nur in der Dokumentation beschriebenen Art und Weise.

Batterie nicht einnehmen. Verbrennungsgefahr durch gefährliche Stoffe

Dieses Produkt enthält Lithium-Knopfzellen. Wenn die Knopfzelle verschluckt wird, können schwere innere Verbrennungen innerhalb von gerade einmal zwei Stunden auftreten und zum Tode führen.

1. Halten Sie neue und gebrauchte Batterien von Kindern fern.
2. Wenn das Batteriefach nicht sicher schließt, dann benutzen Sie das Produkt nicht mehr und halten Sie es von Kindern fern.
3. Wenn Sie meinen, dass Batterien verschluckt wurden oder sich in irgendeinem Körperteil befinden, suchen Sie unverzüglich medizinische Hilfe auf.

Explosionsgefahr durch falschen Batterietyp

Das Einsetzen falscher Batterietypen kann zu einer Explosion führen.

- Verwenden Sie ausschließlich die in den technischen Daten spezifizierten Batterien.



VORSICHT

Feuergefahr durch Batterien

Die eingesetzten Batterien können bei Fehlbehandlung eine Feuer- oder Verbrennungsgefahr darstellen.

1. Versuchen Sie nicht, die Batterien aufzuladen, zu öffnen, zu erhitzen oder zu verbrennen.
2. Schließen Sie die Batterien nicht kurz.

ACHTUNG

Beschädigung durch elektrostatische Entladung (ESD) bei geöffnetem Gehäuse

Dieses Produkt enthält elektronische Bauteile, die durch elektrostatische Entladungen beschädigt werden können.

1. Verwenden Sie ESD-gerechte Arbeitsmaterialien (z.B. Erdungsarmband).
2. Erden Sie sich vor Arbeiten, bei denen Sie mit der Elektronik in Kontakt kommen könnten. Fassen Sie dazu geerdete metallische Oberflächen an (z.B. Türzargen, Wasserrohre oder Heizungsventile).

Beschädigung durch Öle, Fette, Farben und Säuren

Dieses Produkt enthält elektronische und/oder mechanische Bauteile, die durch Flüssigkeiten aller Art beschädigt werden können.

- Halten Sie Öle, Fette, Farben und Säuren vom Produkt fern.

Beschädigung durch aggressive Reinigungsmittel

Die Oberfläche dieses Produkts kann durch ungeeignete Reinigungsmittel beschädigt werden.

- Verwenden Sie ausschließlich Reinigungsmittel, die für Kunststoff- bzw. Metalloberflächen geeignet sind.

Beschädigung durch mechanische Einwirkung

Dieses Produkt enthält elektronische Bauteile, die durch mechanische Einwirkung aller Art beschädigt werden können.

1. Vermeiden Sie das Anfassen der Elektronik.
2. Vermeiden Sie sonstige mechanische Einwirkungen auf die Elektronik.

Beschädigung durch Verpolung

Dieses Produkt enthält elektronische Bauteile, die durch die Verpolung der Spannungsquelle beschädigt werden können.

- Verpolen Sie die Spannungsquelle nicht (Batterien bzw. Netzteile).

Störung des Betriebs durch Funkstörung

Dieses Produkt kann unter Umständen durch elektromagnetische oder magnetische Störungen beeinflusst werden.

- Montieren bzw. platzieren Sie das Produkt nicht unmittelbar neben Geräten, die elektromagnetische oder magnetische Störungen verursachen können (Schaltnetzteile).

Störung der Kommunikation durch metallische Oberflächen

Dieses Produkt kommuniziert drahtlos. Metallische Oberflächen können die Reichweite des Produkts erheblich reduzieren.

- Montieren bzw. platzieren Sie das Produkt nicht auf oder in der Nähe von metallischen Oberflächen.



HINWEIS

Bestimmungsgemäßer Gebrauch

SimonsVoss-Produkte sind ausschließlich für das Öffnen und Schließen von Türen und vergleichbaren Gegenständen bestimmt.

- Verwenden Sie SimonsVoss-Produkte nicht für andere Zwecke.

Funktionsstörungen durch schlechten Kontakt oder unterschiedliche Entladung

Zu kleine/verunreinigte Kontaktflächen oder unterschiedliche entladene Batterien können zu Funktionsstörungen führen.

1. Verwenden Sie nur Batterien, die von SimonsVoss freigegeben sind.
2. Berühren Sie die Kontakte der neuen Batterien nicht mit den Händen.
3. Verwenden Sie saubere und fettfreie Handschuhe.
4. Tauschen Sie immer alle Batterien gleichzeitig aus.

Abweichende Zeiten bei G2-Schließungen

Die interne Zeiteinheit der G2-Schließungen hat eine technisch bedingte Toleranz von bis zu ± 15 Minuten pro Jahr.

Qualifikationen erforderlich

Die Installation und Inbetriebnahme setzt Fachkenntnisse voraus.

- Nur geschultes Fachpersonal darf das Produkt installieren und in Betrieb nehmen.

Änderungen bzw. technische Weiterentwicklungen können nicht ausgeschlossen und ohne Ankündigung umgesetzt werden.

Die deutsche Sprachfassung ist die Originalbetriebsanleitung. Andere Sprachen (Abfassung in der Vertragssprache) sind Übersetzungen der Originalbetriebsanleitung.

Lesen Sie alle Anweisungen zur Installation, zum Einbau und zur Inbetriebnahme und befolgen Sie diese. Geben Sie diese Anweisungen und jegliche Anweisungen zur Wartung an den Benutzer weiter.

3. Produktspezifische Sicherheitshinweise

ACHTUNG

Beschädigung durch Bohren

Sie bohren auf eigene Gefahr. Für Schäden, die durch das Bohren entstanden sind, haftet die SimonsVoss Technologies GmbH nicht.

- Beachten Sie auch die Sicherheitshinweise der Bohrmaschine.

Beschädigung durch ungeeignetes Werkzeug

Wenn Sie versuchen, das Gehäuse mit ungeeignetem Werkzeug zu öffnen, dann kann das Gehäuse beschädigt werden.

- Verwenden Sie nur das mitgelieferte SimonsVoss-Öffnungswerkzeug.

Verlust der präzisen Führung des Drückers

Die Montage kann bei Einsteckschlössern mit Klemmnuss schwergängig sein.

- Bearbeiten Sie die Klemmnuss nicht mechanisch. Der Drücker verliert dabei seine passgenaue Führung.

Erschwerte Montage durch ungenaue Bohrungen

Der Beschlag ist nicht montierbar, wenn die Befestigungsbohrungen und der Vierkant nicht zueinander passen.

- Stellen Sie sicher, dass die Befestigungsbohrungen und der Vierkant auf einer vertikalen Linie sind.



HINWEIS

Wirkung auf das Einsteckschloss

Das SmartHandle AX wirkt ausschließlich auf die Falle des Einsteckschlössers.

Versicherungsrechtliches Verschließen

Versicherungen stellen erhöhte Anforderungen an eine Schließung.

1. Wenn Sie die Tür versicherungsrechtlich verschließen wollen, dann verwenden Sie ein selbstverriegelndes Panikschloss (SVP) oder zusätzlich zum SmartHandle AX einen Schließzylinder.
2. Achten Sie auf die Zulassungen nach EN 179.

SmartHandle mit selbstverriegelndem Panikschloss

Das SmartHandle AX bietet nur mit einem selbstverriegelndem Panikschloss die volle Funktionalität.

1. Kombinieren Sie das SmartHandle AX mit einem selbstverriegelndem Panikschloss (SVP).
2. Achten Sie auf die Konformitätserklärungen der Schlosshersteller nach EN 179.

Auflagen zur Berechtigungssicherheit

Der Betrieb mit Mifare Classic und/oder PinCode-Tastatur schließt die Berechtigungssicherheit Klasse D nach DIN EN 16867:2020 aus.

Verschluss der Rosettenöffnung

Eine ggfs. vorhandene Rosettenöffnung kann für Manipulationen genutzt werden.

1. Verschließen Sie ggfs. vorhandene Rosettenöffnungen, zum Beispiel mit einem Blindzylinder.
2. Bei FH-Varianten: Bauen Sie zwingend einen Blind- oder Schließzylinder aus Messing ein.

4. Lieferumfang

- SmartHandle AX (Rohrrahmen-Variante)
 - Spezialwerkzeug
 - Kurzanleitung
- Für FH-Variante:
- Blindzylinder

5. Aufbau



6. Tür vorbereiten (Bohrschablone)

- ✓ PH2-Schraubendreher vorhanden.
- ✓ Stift oder Anreißnadel vorhanden.
- ✓ Bohrmaschine vorhanden.
- ✓ Geeigneter Bohrer vorhanden (Ø 7,2 mm).
- ✓ Kegelsenker vorhanden.

1. Stecken Sie den Vierkant in das Einsteckschloss. 2
2. Stecken Sie die Bohrschablone auf den Vierkant. 3
3. Richten Sie die Bohrschablone mithilfe der aufgedruckten Skala senkrecht aus.
4. Markieren Sie die zu bohrenden Punkte auf der Tür. 4
5. Entfernen Sie die Bohrschablone. 5
6. Entfernen Sie den Vierkant. 6
7. Bauen Sie das Einsteckschloss aus (PH2). 7
8. Bohren Sie die benötigten Löcher. 8
9. Senken Sie die Löcher mit dem Kegelsenker soweit an, sodass die Blindnietmuttern später bündig eingepresst werden können. 9
10. Bauen Sie das Einsteckschloss ein (PH2). 10

7. Für Türdicke X: Vierkant vorbereiten

- ✓ Säge vorhanden.
- ✓ Messschieber vorhanden.
- ✓ PH2-Schraubendreher vorhanden.

1. Für X: Messen Sie die Türdicke. 11
2. Für X: Markieren Sie die Sägestelle am Vierkant.



HINWEIS

9-mm-Vierkant mit 8-mm-Ende

Der 9-mm-Vierkant hat ein 8-mm-Ende. Dieses Ende wird in den elektronischen Beschlag gesteckt.

- Kürzen Sie den 9-mm-Vierkant so, dass das 8-mm-Ende sich nicht im Abfallteil befindet.

















3. Für X: Kürzen Sie mit einer geeigneten Säge den Vierkant. 13

8. Beschlag programmieren



Programmieren Sie den Beschlag vor der Montage. Je nach Produktfamilie können Sie verschiedene Programmiergeräte verwenden.



9. Beschlag montieren

- ✓ Tür vorgebohrt.
 - ✓ PH2-Schraubendreher vorhanden.
 - ✓ TX15-Schraubendreher vorhanden.
1. Setzen Sie die mitgelieferten Blindnietmuttern in den Türrahmen.  17
 2. Schrauben Sie die Montageplatte auf der Außenseite so fest, dass die Federklammern zur Tür zeigen (PH2, Drehmoment: 1,1 Nm).  18
 3. Schrauben Sie die Rosettenbasis auf der Außenseite fest (PH2, Drehmoment: 1,1 Nm).  19
 4. Schrauben Sie die Rosettenbasis auf der Innenseite fest (PH2, Drehmoment: 1,1 Nm).
 5. Stecken Sie den Beschlag in die Aufnahmen der Montageplatte.  20
 6. Schieben Sie den Beschlag in der Montageplatte bis zum Anschlag nach unten.  21
 7. Schrauben Sie den Beschlag an der Montageplatte fest (PH1, Drehmoment: 0,8 Nm).  22
 8. Stecken Sie eine Blende mit der Einkerbung nach unten auf die Rosettenbasis.  23
 9. Stecken Sie das Cover auf den Beschlag.  24
 10. Stecken Sie den Außendrücker auf den Beschlag.  25
 11. Bestimmen Sie die gewünschte Drehrichtung Ihres Innendrückers.
 12. Setzen Sie das Federelement entsprechend ein.
 13. Setzen Sie die Unterlage in die Innendrücker-Einheit.  26  27
 14. Für 8,5-mm- und 10-mm-Vierkant: Schieben Sie die Adapterhülse in die Mitte des Vierkants. Machen Sie mit Körner und Hammer eine Vertiefung in die Adapterhülse, um das Verrutschen zu verhindern.  28  29
 15. Messen Sie die Gesamtlänge des Vierkants.  30
 16. Ermitteln Sie die Innenseite des Vierkants (Vierkantende bis Mitte erster Rille = 26 mm).
 17. Bestimmen Sie die Position des O-Rings mit der Tabelle.  31

Bereich	Türdicke (mm)	Vierkantlänge (mm)	Ringposition
S	40 - 42	94	3
S	40 - 42	104	5
S	43 - 47	94	2
S	43 - 47	104	4
S	48 - 52	94	1
S	48 - 52	104	3
S	53 - 57	104	2
S	58 - 61	104	1
M	60 - 62	114	3
M	60 - 62	124	5
M	63 - 67	114	2
M	63 - 67	124	4
M	68 - 72	114	1
M	68 - 72	124	3
M	73 - 77	124	2
M	78 - 81	124	1
L	80 - 82	134	3
L	80 - 82	144	5
L	83 - 87	134	2
L	83 - 87	144	4
L	88 - 92	134	1
L	88 - 92	144	3
L	93 - 97	144	2
L	98 - 101	144	1
XL	100 - 184	O-Ring liegt 30-35 mm vom abgesägten Ende des Vierkants.	

18. Schieben Sie den O-Ring auf die berechnete Rille.  32
19. Stecken Sie den Vierkant mit der ringfreien Seite bis zum Anschlag in die Tür.  33
20. Für FH: Setzen Sie den Blindzylinder ein.



HINWEIS

Blindzylinder mit Schraubendreher im Loch führen

Insbesondere bei dicken Türen ist es schwierig, den Blindzylinder richtig zu positionieren.

1. Stecken Sie einen Schraubendreher in das Loch des Blindzylinders.
2. Positionieren Sie den Blindzylinder mithilfe des Schraubendrehers.



21. Für FH: Schrauben Sie den Blindzylinder fest (PH2, Drehmoment: 1,1 Nm).



22. Schrauben Sie die Innendrücker-Einheit auf den Vierkant (PH2, Drehmoment: 1,1 Nm).



23. Schrauben Sie die Rosettenbasis auf der Innenseite fest (PH2, Drehmoment: 1,1 Nm).



24. Schrauben Sie die Madenschrauben beider Drücker fest (TX15, Drehmoment: 5,0 Nm).



25. Stecken Sie die Innendrucker-Blende mit der Einkerbung nach unten auf die Innendrucker-Rosette.



26. Stecken Sie eine Blende mit der Einkerbung nach unten auf die Rosettenbasis.



- ↳ Beschlag ist fertig montiert.

10. Beschlag demontieren

- ✓ 1,5-mm-Sechskantschlüssel vorhanden.

1. Demontieren Sie den Beschlag in umgekehrter Reihenfolge zur Montage.
2. Stecken Sie einen 1,5-mm-Sechskantschlüssel in das Loch der Vierkantaufnahme im Beschlag.



3. Biegen Sie den Sechskantschlüssel auf die Seite, auf der sich das Loch befindet und ziehen Sie gleichzeitig am Außendrücker.



- ↳ Beschlag ist demontiert.

11. Batterien wechseln



HINWEIS

Funktionsstörungen durch schlechten Kontakt oder unterschiedliche Entladung

Zu kleine/verunreinigte Kontaktflächen oder unterschiedliche entladene Batterien können zu Funktionsstörungen führen.

1. Verwenden Sie nur Batterien, die von SimonsVoss freigegeben sind.
2. Berühren Sie die Kontakte der neuen Batterien nicht mit den Händen.
3. Verwenden Sie saubere und fettfreie Handschuhe.
4. Tauschen Sie immer alle Batterien gleichzeitig aus.

- ✓ Spezialwerkzeug ist vorhanden.
✓ Handschuhe vorhanden.

1. Stecken Sie das Spezialwerkzeug in das Cover-Inlay des Beschlags.



2. Nehmen Sie das Cover mit dem Werkzeug ab.



3. Biegen Sie die Batteriekammer vorsichtig nach innen, um sie auszuheben.



4. Öffnen Sie die Batteriekammer.



5. Ziehen Sie die Batteriekammer heraus.



6. Entnehmen Sie die alten Batterien.



7. Setzen Sie die neuen Batterien mit sich berührenden Pluspolen ein (Typ CR2450).



8. Setzen Sie die Batteriekammer wieder ein.



9. Haken Sie die Batterie-Klammer wieder ein.



10. Stecken Sie das Cover wieder auf den Beschlag.



11. Klipsen Sie das Cover wieder fest.



- ↳ Batterien sind gewechselt.

12. Technische Daten

Temperaturbereich (Betrieb)	-25 °C bis +50 °C
Batterietyp	4× CR2450 (3V)
Batteriehersteller	<ul style="list-style-type: none"> ■ Murata ■ Varta ■ Panasonic
IP-Schutzklasse	IP40

Funkemissionen

15,24 kHz - 72,03 kHz Nur für Artikelnummern: SV-S2.*A*, SV-S2.*AM*, SV-S2.*LN*	10 dBµA/m (3 m Entfernung)
13,560006 MHz - 13,560780 MHz	1,04 dBµA/m (3 m Entfernung)
868,000 MHz - 868,600 MHz / 869,700 MHz - 870,000 MHz Nur für Artikelnummern: SV-S2.*LN*, SI-S2.*M.WO*	<25 mW ERP
2402 MHz - 2480 MHz	2,5 mW

13. Konformitätserklärung

Hiermit erklärt die SimonsVoss Technologies GmbH, dass die Artikel (SV-S2.*A*, SV-S2.*AM*, SV-S2.*LN*, SI-S2.*M.WO*, SI-S2.*M.VCN*) folgenden Richtlinien entsprechen:

- 2014/53/EU -Funkanlagen- bzw. für UK: Rechtsverordnung 2017 Nr. 1206 -Funkanlagen-
- 2011/65/EU -RoHS- bzw. für UK: Rechtsverordnung 2012 Nr. 3032 -RoHS-



Der vollständige Text der EU-Konformitätserklärung ist unter der folgenden Internetadresse verfügbar: www.simons-voss.com/de/zertifikate.html.
Der vollständige Text der UK-Konformitätserklärung ist unter der folgenden Internetadresse verfügbar: www.simons-voss.com/de/zertifikate.html.

14. Hilfe und weitere Informationen

Infomaterial/Dokumente

<https://www.simons-voss.com/de/dokumente.html>
<https://www.smartintego.com/de/home/infocenter/dokumentation>

Konformitätserklärungen und Zertifikate

<https://www.simons-voss.com/de/zertifikate.html>

Informationen zur Entsorgung

- Entsorgen Sie das Gerät (SV-S2.*A*, SV-S2.*AM*, SV-S2.*LN*, SI-S2.*M.WO*, SI-S2.*M.VCN*) nicht mit dem Hausmüll, sondern gemäß der europäischen Richtlinie 2012/19/EU bei einer kommunalen Sammelstelle für Elektro-Sonderabfälle.
- Recyceln Sie defekte oder verbrauchte Batterien gemäß der europäischen Richtlinie 2006/66/EG.
- Beachten Sie örtliche Bestimmungen zur getrennten Entsorgung von Batterien.
- Führen Sie die Verpackung einer umweltgerechten Wiederverwertung zu.



E-Mail

support-simonsvoss@allegion.com

si-support-simonsvoss@allegion.com

SimonsVoss Technologies GmbH, Feringastr. 4, D-85774 Unterfoehring,
Deutschland

1. Intended use

Products in the SmartHandle AX range consist of electronic door fittings. Users can engage SmartHandle AX and open the door onto which it is fitted with an authorised ID medium, such as a transponder.

The corresponding authorisations need to be issued using an electronic locking plan.

Products in the SmartHandle AX range may only be used for locking and unlocking doors. No other use is permitted.

2. General safety instructions

Signal word: Possible immediate effects of non-compliance

WARNING: Death or serious injury (possible, but unlikely), CAUTION: Minor injury, IMPORTANT: Property damage or malfunction, NOTE: Low or none



WARNING

Blocked access

Access through a door may stay blocked due to incorrectly fitted and/or incorrectly programmed components. SimonsVoss Technologies GmbH is not liable for the consequences of blocked access such as access to injured or endangered persons, material damage or other damage!

Blocked access through manipulation of the product

If you change the product on your own, malfunctions can occur and access through a door can be blocked.

- Modify the product only when needed and only in the manner described in the documentation.

Do not swallow battery. Danger of burns from hazardous substances

This product contains lithium button cell batteries. Swallowing the button cell battery, in can result in severe internal burns leading to death in as little as two hours.

- Keep new and used batteries away from children.
- If the battery compartment does not close securely, cease using the product and keep it away from children.
- If you think batteries have been swallowed or are in any part of the body, seek medical attention immediately.

Risk of explosion due to incorrect battery type

Inserting the wrong type of battery can cause an explosion.

- Only use the BATTERIES specified in the technical data.



CAUTION

Fire hazard posed by batteries

The batteries used may pose a fire or burn hazard if handled incorrectly.

- Do not try to charge, open, heat or burn the batteries.
- Do not short-circuit the batteries.

IMPORTANT

Damage resulting from electrostatic discharge (ESD) when enclosure is open

This product contains electronic components that may be damaged by electrostatic discharges.

- Use ESD-compliant working materials (e.g. Grounding strap).
- Ground yourself before carrying out any work that could bring you into contact with the electronics. For this purpose, touch earthed metallic surfaces (e.g. door frames, water pipes or heating valves).

Damage resulting from liquids

This product contains electronic and/or mechanic components that may be damaged by liquids of any kind.

- Keep liquids away from the electronics.

Damage resulting from aggressive cleaning agents

The surface of this product may be damaged as a result of the use of unsuitable cleaning agents.

- Only use cleaning agents that are suitable for plastic or metal surfaces.

Damage as a result of mechanical impact

This product contains electronic components that may be damaged by mechanical impacts of any kind.

- Avoid touching the electronics.
- Avoid other mechanical influences on the electronics.

Damage due to polarity reversal

This product contains electronic components that may be damaged by reverse polarity of the power source.

- Do not reverse the polarity of the voltage source (batteries or mains adapters).

Operational malfunction due to radio interference

This product may be affected by electromagnetic or magnetic interference.

- Do not mount or place the product directly next to devices that could cause electromagnetic or magnetic interference (switching power supplies!).

Communication interference due to metallic surfaces

This product communicates wirelessly. Metallic surfaces can greatly reduce the range of the product.

- Do not mount or place the product on or near metallic surfaces.



NOTE

Intended use

SimonsVoss-products are designed exclusively for opening and closing doors and similar objects.

- Do not use SimonsVoss products for any other purposes.

Malfunctions due to poor contact or different discharge

Contact surfaces that are too small/contaminated or different discharged batteries can lead to malfunctions.

- Only use batteries that are approved by SimonsVoss.
- Do not touch the contacts of the new batteries with your hands.
- Use clean and grease-free gloves.
- Always replace all batteries at the same time.

Different times for G2 locks

The internal time unit of the G2 locks has a technical tolerance of up to ± 15 minutes per year.

Qualifications required

The installation and commissioning requires specialized knowledge.

- Only trained personnel may install and commission the product.

Modifications or further technical developments cannot be excluded and may be implemented without notice.

The German language version is the original instruction manual. Other languages (drafting in the contract language) are translations of the original instructions.

Read and follow all installation, installation, and commissioning instructions. Pass these instructions and any maintenance instructions to the user.

3. Product-specific safety instructions

IMPORTANT

Damage by drilling

You drill at your own risk. SimonsVoss Technologies GmbH is not liable for damage caused by drilling.

- Please also observe the safety instructions of the drilling machine.

Damage caused by unsuitable tools

If you try to open the case with unsuitable tools, the case may be damaged.

- Use only the supplied SimonsVoss opening tool.

Loss of the precise guidance of the handle

It may be difficult to install on mortise locks with a retaining nut.

- Do not mechanically alter the locking nut. The handle would then lose its precise guidance.

Difficult installation due to inaccurate holes

The fitting cannot be installed if the fastening holes and the spindle do not match.

- Make sure that the fastening holes and the spindle are in a vertical line.

**NOTE****Effect on the mortise lock**

The SmartHandle AX acts exclusively on the latch of the mortise lock.

Locking and insurances

Insurance companies place increased demands on a closure.

1. If you want to lock the door under insurance law, use a self-locking panic lock or a locking cylinder in addition to the SmartHandle AX.
2. Pay attention to the approvals according to EN 179.

SmartHandle AX with self-locking panic lock

The SmartHandle AX only offers full functionality with a self-locking panic lock.

1. Combine the SmartHandle AX with a self-locking panic lock.
2. Pay attention to the declarations of conformity of the lock manufacturers according to EN 179.

Conditions for authorisation security

Operation with Mifare Classic and/or PinCode keypad excludes authorisation security class D according to DIN EN 16867:2020.

Sealing escutcheon holes

Any escutcheon holes that exist may be used to manipulate the lock.

1. Seal any escutcheon holes with a blind cylinder, for example.
2. In the case of FH versions, you must install a brass dummy cylinder or locking cylinder.

4. Scope of delivery

- SmartHandle AX (metal frame version)
- Special tool
- Quick guide

For FH version:

- Blank cylinder

5. Design



6. Prepare door (drilling template)

- ✓ PH2 screwdriver at hand.
- ✓ Pin or scribe at hand.
- ✓ Drill at hand.
- ✓ Suitable drill bit at hand (Ø 7.2 mm).
- ✓ Countersink at hand.

1. Insert the spindle into the mortise lock.



2. Place the drilling template on the spindle.



3. Align the drill template vertically using the printed scale.

4. Mark the points to be drilled on the door.



5. Remove the drilling template.



6. Remove the spindle.



7. Remove the mortise lock (PH2).



8. Drill the required holes.



9. Countersink the holes with the countersink so that the blind rivet nuts can be pressed into a flush position later.



10. Fit the mortise lock (PH2).



7. For door thickness X: prepare spindle

- ✓ Saw at hand.
- ✓ Vernier calliper at hand.
- ✓ PH2 screwdriver at hand.

1. For X: measure the door thickness.



2. For X: mark the sawing point on the spindle.

**NOTE****9 mm spindle with 8 mm end**

The 9 mm spindle has an 8 mm end. This end is inserted into the electronic fitting.

- Trim the 9 mm spindle, ensuring that the 8 mm end is not the cut part.



3. For X: trim the spindle with a suitable saw.



8. Programming the fitting

Programme the fitting before installation. You can use different programming devices, depending on the product family.



9. Installing the fitting

- ✓ Door pre-drilled.
- ✓ PH2 screwdriver at hand.
- ✓ TX15 screwdriver at hand.

1. Insert the supplied blind rivet nuts into the door frame.



2. Screw the mounting plate firmly into place on the outside so that the spring clips are facing the door (PH2, torque 1.1 Nm).



3. Screw the escutcheon base firmly to the outside (PH2, torque 1.1 Nm).



4. Screw the escutcheon base firmly into place on the inside (PH2, torque 1.1 Nm).

5. Insert the fitting into the mounts on the mounting plate.











6. Push the fitting into the mounting plate until it locks into position.





7. Screw the fitting firmly to the mounting plate (PH1, torque 0.8 Nm).



8. Place a cover with the notch facing downwards on the escutcheon base.
 23
9. Place the cover on the fitting.
 24
10. Fit the outside handle into position on the fitting.
 25
11. Determine the required direction of rotation for your inner handle.
12. Insert the spring element appropriately.
13. Place the underlay in the inner handle unit.
 26
 27
14. For 8.5 mm and 10 mm spindle: slide the adapter sleeve into the centre of the spindle. Use a punch and hammer to make an indent in the adapter sleeve to prevent it from slipping.
 28
 29
15. Measure the total length of the spindle.
 30
16. Locate the inside of the spindle (four-edge end up to the centre of the first groove = 26 mm).
17. Use the table to determine the position of the O-ring.
 31

Area	Door thickness (mm)	Spindle length (mm)	Ring position
S	40 - 42	94	3
S	40 - 42	104	5
S	43 - 47	94	2
S	43 - 47	104	4
S	48 - 52	94	1
S	48 - 52	104	3
S	53 - 57	104	2
S	58 - 61	104	1
M	60 - 62	114	3
M	60 - 62	124	5
M	63 - 67	114	2
M	63 - 67	124	4
M	68 - 72	114	1
M	68 - 72	124	3
M	73 - 77	124	2
M	78 - 81	124	1
L	80 - 82	134	3
L	80 - 82	144	5
L	83 - 87	134	2
L	83 - 87	144	4
L	88 - 92	134	1
L	88 - 92	144	3
L	93 - 97	144	2
L	98 - 101	144	1
XL	100 - 184	O-ring is 30–35 mm from the cut end of the spindle.	

18. Slide the O-ring onto the calculated groove.
 32







19. Insert the spindle into the door with the ring-free side as far as it will go.
 33
20. For FH: insert the dummy cylinder.

**NOTE****Feed the blank cylinder into the hole using a screwdriver**

It is difficult to position the blank cylinder correctly, especially in thick doors.

1. Insert a screwdriver into the hole in the blank cylinder.
2. Position the blank cylinder using the screwdriver.





21. For FH: screw the dummy cylinder firmly into place (PH2, torque 1.1 Nm).
 36
22. Screw the inner handle unit onto the spindle (PH2, torque 1.1 Nm).
 37
23. Screw the escutcheon base firmly into place on the inside (PH2, torque 1.1 Nm).
 38
24. Fasten the grub screws firmly onto both handles (TX15, torque 5.0 Nm).
 39
25. Place the inner handle cover with the notch facing downwards onto the inner handle escutcheon.
 40
26. Place a cover with the notch facing downwards on the escutcheon base.
 41

↳ Fitting is now installed.

10. Removing the fitting

✓ 1.5 mm hexagonal wrench available.

1. Remove the fitting in the reverse order to installation.
2. Insert a 1.5 mm hex key into the hole in the spindle mount in the fitting.
 42
3. Bend the hex key to the side where the hole is located while pulling on the outside handle.
 43

↳ Fitting is now removed.

11. Replacing the batteries

**NOTE****Malfunctions due to poor contact or different discharge**

Contact surfaces that are too small/contaminated or different discharged batteries can lead to malfunctions.

1. Only use batteries that are approved by SimonsVoss.
2. Do not touch the contacts of the new batteries with your hands.
3. Use clean and grease-free gloves.
4. Always replace all batteries at the same time.











✓ Special tool at hand.
✓ Gloves at hand.

1. Insert the special tool into the fitting's cover inlay.



2. Remove the cover with the tool.



3. Carefully bend the battery clip inwards to detach it.
 -  46
 -  47
 -  48
 4. Open the battery holder.
 -  49
 5. Remove the battery holder.
 -  50
 6. Remove the old batteries.
 -  51
 7. Insert the new batteries with the positive terminals next to each other (type CR2450).
 -  52
 8. Put the battery holder back into place.
 -  53
 9. Reattach the battery clip.
 -  54
 10. Replace the cover on the fitting.
 -  55
 11. Snap the cover back into place.
 -  56
- ↳ Batteries are now replaced.

12. Technical data

Operating temperature range	-25 °C to +50 °C
Battery type	4x CR2450 (3V)
Battery manufacturer	<ul style="list-style-type: none"> ■ Murata ■ Varta ■ Panasonic
IP protection rating	IP40

Radio emissions

15.24 kHz - 72.03 kHz Only for item numbers: SV-S2.*A*, SV-S2.*AM*, SV-S2.*LN*	10 dBµA/m (3 m distance)
13.560006 MHz - 13.560780 MHz	1.04 dBµA/m (3 m distance)
868.000 MHz - 868.600 MHz / 869.700 MHz - 870.000 MHz Only for item numbers: SV-S2.*LN*, SI-S2.*M.WO*	<25 mW ERP
2402 MHz - 2480 MHz	2.5 mW

13. Declaration of conformity

The company SimonsVoss Technologies GmbH hereby declares that the articles (SV-S2.*A*, SV-S2.*AM*, SV-S2.*LN*, SI-S2.*M.WO*, SI-S2.*M.VCN*) comply with the following guidelines:

- 2014/53/EU - RED-
or for the UK: UK statutory 2017 No. 1206 -Radio equipment-
- 2011/65/EU - RoHS-
or for the UK: UK statutory 2012 No. 3032 -RoHS-



The full text of the EU Declaration of conformity is available at the following internet address: www.simons-voss.com/en/certificates.html.

The full text of the UK Declaration of conformity is available at the following internet address: www.simons-voss.com/en/certificates.html.

14. Help and other information

Information material/documents

<https://www.simons-voss.com/en/documents.html>

<https://www.smartintego.com/int/home/infocenter/documentation>

Declarations of conformity

<https://www.simons-voss.com/en/certificates.html>

Information on disposal

- Do not dispose of the device (SV-S2.*A*, SV-S2.*AM*, SV-S2.*LN*, SI-S2.*M.WO*, SI-S2.*M.VCN*) in the household waste. Dispose of it at a collection point for electronic waste as per European Directive 2012/19/EU.
- Recycle defective or used batteries in line with European Directive 2006/66/EC.
- Observe local regulations on separate disposal of batteries.
- Take the packaging to an environmentally responsible recycling point.



Email

support-simonsvoss@allegion.com

si-support-simonsvoss@allegion.com

SimonsVoss Technologies GmbH, Feringastr. 4, D-85774 Unterfoehring, Germany

1. Utilisation conforme

Les produits de la série SmartHandle AX sont des béquilles électroniques. Au moyen d'un support d'identification autorisé, la SmartHandle AX peut réaliser un accouplement ou ouvrir la porte correspondante.

Les autorisations correspondantes doivent être accordées au moyen d'un plan de fermeture électronique.

Les produits de la série SmartHandle AX ne doivent servir qu'à ouvrir et fermer des portes. Toute autre utilisation est interdite.

2. Consignes de sécurité générales

Mot indicateur: Effets immédiats possibles du non-respect

AVERTISSEMENT: Mort ou blessure grave (possible, mais improbable), PRU-DENCE: Blessure légère, ATTENTION: Dommages matériels ou dysfonctionnements, NOTE: Peu ou pas



AVERTISSEMENT

Accès bloqué

Toute erreur de montage et/ou de programmation d'un composant peut bloquer l'accès par une porte. La société SimonsVoss Technologies GmbH décline toute responsabilité quant aux conséquences d'un accès bloqué, par exemple, accès pour les personnes blessées ou en danger, dommages matériels ou autres dommages !

Accès bloqué par la manipulation du produit

Si vous modifiez vous-même le produit, des dysfonctionnements peuvent se produire et l'accès peut être bloqué par une porte.

- Ne changer le produit que lorsque cela est nécessaire et de la manière décrite dans la documentation.

Ne pas saisir la pile. Risque de brûlures dues à des substances dangereuses

Ce produit contient des piles au lithium. En cas d'ingestion de la pile, de graves brûlures internes peuvent se produire sous deux heures et entraîner la mort.

- Conservez les piles neuves et usagées hors de portée des enfants.
- Si le compartiment à piles ne ferme pas correctement, cessez d'utiliser le produit et conservez-le hors de portée des enfants.
- En cas de suspicion d'ingestion des piles ou si celles-ci se trouvent dans une partie quelconque de votre corps, consultez immédiatement un médecin.

Risque d'explosion dû à un type de batterie incorrect

L'insertion d'un mauvais type de batterie peut provoquer une explosion.

- Utilisez uniquement les piles indiquées dans les données techniques.



PRUDENCE

Risque d'incendie dû aux piles

En cas de manipulation impropre, les piles insérées peuvent provoquer un incendie ou des brûlures.

- Ne jamais essayer de recharger les piles, de les ouvrir, de les chauffer ou de les brûler.
- Ne pas court-circuiter les piles.

ATTENTION

Endommagement lié à une décharge électrostatique (DES) lorsque le boîtier est ouvert

Ce produit contient des composants électroniques susceptibles d'être endommagés par des décharges électrostatiques.

- Utilisez du matériel de travail adapté à la DES (par ex. un bracelet de mise à la terre).
- Reliez-vous à la terre avant de commencer les travaux pendant lesquels vous pouvez être en contact avec le système électronique. Saisissez pour cela des surfaces métalliques mises à la terre (par ex. huisseries de porte, conduites d'eau ou vannes de chauffage).

Endommagement lié à des liquides

Ce produit contient des composants électroniques et/ou mécaniques susceptibles d'être endommagés par tout type de liquide.

- Tenez les liquides à l'écart du système électronique.

Endommagement lié à des nettoyeurs agressifs

La surface de ce produit peut être endommagée par des nettoyeurs inappropriés.

- Utilisez exclusivement des nettoyeurs adaptés aux surfaces plastiques ou métalliques.

Endommagement lié à une action mécanique

Ce produit contient des composants électroniques susceptibles d'être endommagés par une action mécanique quelconque.

- Évitez de toucher le système électronique.
- Évitez toute autre action mécanique sur le système électronique.

Endommagement lié à une inversion de polarité

Ce produit contient des composants électroniques susceptibles d'être endommagés par une inversion de polarité de la source de tension.

- N'inversez pas la polarité de la source de tension (piles ou blocs d'alimentation).

Défaillance du fonctionnement liée à une perturbation radioélectrique

Dans certaines circonstances, ce produit peut subir l'influence de perturbations électromagnétiques ou magnétiques.

- Ne montez pas et ne placez pas le produit à proximité immédiate d'appareils pouvant générer des perturbations électromagnétiques ou magnétiques (alimentations à découpage !).

Défaillance de la communication liée à des surfaces métalliques

Ce produit communique sans fil. Les surfaces métalliques peuvent réduire considérablement le rayon d'action du produit.

- Ne montez pas et ne placez pas le produit sur ou à proximité de surfaces métalliques.



NOTE

Utilisation conforme aux dispositions

Les produits SimonsVoss sont exclusivement destinés à l'ouverture et la fermeture de portes et d'objets similaires.

- N'utilisez pas les produits SimonsVoss à d'autres fins.

Horaires différents pour les fermetures G2

L'unité de temps interne des fermetures G2 présente une tolérance technique pouvant atteindre ± 15 minutes par an.

Qualifications requises

L'installation et la mise en service nécessitent des connaissances spécialisées.

- Seul le personnel qualifié peut installer et mettre en service le produit.

Dysfonctionnements dus à un mauvais contact ou à une décharge différée

Des surfaces de contact trop petites/contaminées ou différentes batteries déchargées peuvent entraîner des dysfonctionnements.

- Utilisez uniquement des piles autorisées par la société SimonsVoss.
- Ne touchez pas les contacts des piles neuves avec les mains.
- Utilisez des gants propres et exempts de graisse.
- Remplacez toujours toutes les piles à la fois.

Les modifications et nouveaux développements techniques ne peuvent pas être exclus et peuvent être mis en œuvre sans préavis.

La version allemande est le manuel d'instruction original. Les autres langues (rédaction dans la langue du contrat) sont des traductions des instructions originales.

Lisez et suivez toutes les instructions d'installation, d'installation et de mise en service. Transmettez ces instructions et toutes les instructions de maintenance à l'utilisateur.

3. Consignes de sécurité spécifiques au produit

ATTENTION

Dommmages causés par le perçage

Vous percez à vos risques et périls. SimonsVoss Technologies GmbH n'est pas responsable des dommages causés par le forage.

- Respectez également les consignes de sécurité de la perceuse.

Dommmages causés par des outils inadapés

Si vous essayez d'ouvrir le boîtier avec des outils inappropriés, le boîtier peut être endommagé.

- Utilisez uniquement l'outil d'ouverture SimonsVoss fourni.

Perte de précision du guidage de la poignée

Dans le cas de serrures encastrées avec douille de serrage, le montage peut être difficile.

- N'usinez pas la douille de serrage mécaniquement. Le guidage de la poignée perd de sa précision.

Montage difficile en raison de perçages imprécis

La ferrure ne peut pas être montée si les perçages de fixation et le carré ne concordent pas.

- Assurez-vous que les trous de fixation et le carré sont alignés verticalement.



NOTE

Effet sur la serrure à mortaiser

La SmartHandle AX agit exclusivement sur le loquet de la serrure à mortaiser.

Verrouillage en vertu du droit des assurances

Les compagnies d'assurance exigent de plus en plus une fermeture.

1. Si vous souhaitez verrouiller la porte en vertu du droit des assurances, utilisez une serrure antipanique autobloquante ou un cylindre de fermeture en plus de la SmartHandle AX.
2. Respecter les homologations selon EN 179.

SmartHandle avec serrure antipanique autobloquante

Le SmartHandle AX offre uniquement une fonctionnalité complète avec une serrure antipanique autobloquante.

1. Combinez la SmartHandle AX avec une serrure anti-panique autobloquante.
2. Respecter les déclarations de conformité des fabricants de serrures selon EN 179.

Obligations relatives à la sécurité d'autorisation

Le fonctionnement avec Mifare Classic et/ou clavier PinCode exclut la sécurité d'autorisation de classe D selon DIN EN 16867:2020.

Fermeture de l'ouverture de la rosace

Une ouverture de rosace éventuellement existante peut être utilisée pour des manipulations.

1. Fermez le cas échéant les ouvertures de rosace existantes, par exemple avec un cylindre borgne.
2. Pour les variantes FH : Installez impérativement un cylindre borgne ou un cylindre de fermeture en laiton.

4. Contenu de la livraison

- SmartHandle AX (version à cadre tubulaire)
- Outil spécial
- Notice abrégée

Pour la variante FH :

- Cylindre borgne

5. Construction



6. Préparation de la porte (gabarit de perçage)

- ✓ Tournevis PH2 présent.
- ✓ Stylo ou pointe à tracer présent.
- ✓ Perceuse présente.
- ✓ Foret approprié disponible ($\varnothing 7,2$ mm).
- ✓ Chanfrein conique présent.

1. Insérez le carré dans la serrure à mortaise.



2. Placez le gabarit de perçage sur le carré.



3. Alignez le gabarit de perçage verticalement à l'aide de l'échelle imprimée.

4. Marquez les points à percer sur la porte.



5. Enlevez le gabarit de perçage.



6. Enlevez le carré.



7. Démontez la serrure à mortaise (PH2).



8. Percez les trous nécessaires.



9. Chanfreinez les trous à l'aide du chanfrein conique jusqu'à ce que les écrous à rivet borgne puissent être enfoncés à fleur ultérieurement.



10. Montez la serrure à mortaise (PH2).



7. Pour épaisseur de porte X : Préparation du carré

- ✓ Scie présente.
- ✓ Pied à coulisse présent.
- ✓ Tournevis PH2 présent.

1. Pour X : Mesurez l'épaisseur de la porte.



2. Pour X : Marquez le cadre de sciage sur le carré.



NOTE

Carré de 9 mm avec extrémité de 8 mm

Le carré de 9 mm a une extrémité de 8 mm. Cette extrémité est insérée dans la ferrure électronique.

- Raccourcissez le carré de 9 mm de sorte que l'extrémité de 8 mm ne se trouve pas dans la pièce de rebut.



3. Pour X : Raccourcissez le carré à l'aide d'une scie appropriée.



8. Programmation de la ferrure

Programmez la ferrure avant le montage. En fonction de la famille de produits, vous pouvez utiliser différents appareils de programmation.





15



16

9. Montage de la ferrure

- ✓ Porte prépercée.
- ✓ Tournevis PH2 présent.
- ✓ Tournevis TX15 présent.

1. Insérez les écrous à rivet borgne fournis dans le cadre de porte.



17

2. Vissez la plaque de montage à l'extérieur de manière à ce que les clips à ressort soient orientés vers la porte (PH2, couple : 1,1 Nm).



18

3. Vissez la base de la rosace à l'extérieur (PH2, couple de serrage : 1,1 Nm).



19

4. Vissez la base de la rosace à l'intérieur (PH2, couple de serrage : 1,1 Nm).

5. Insérez la ferrure dans les logements de la plaque de montage.



20

6. Poussez la ferrure vers le bas dans la plaque de montage jusqu'à la butée.



21

7. Vissez la ferrure sur la plaque de montage (PH1, couple : 0,8 Nm).



22

8. Insérez une blinde avec l'encoche vers le bas sur la base de la rosace.



23

9. Enfichez le cache de protection sur la ferrure.



24

10. Insérez la béquille extérieure sur la ferrure.



25

11. Déterminez le sens de rotation souhaité de votre béquille intérieure.

12. Insérez l'élément à ressort en conséquence.

13. Placez le support dans l'unité de la béquille intérieure.



26



27

14. Pour carrés de 8,5 mm et 10 mm : Faites glisser la douille de l'adaptateur au centre du carré. À l'aide d'un pointeau et d'un marteau, faites un creux dans la douille de l'adaptateur pour l'empêcher de glisser.



28



29

15. Mesurez la longueur totale du carré.



30

16. Déterminez le côté intérieur du carré (extrémité du carré jusqu'au milieu de la première rainure = 26 mm).

17. Déterminez la position du joint torique à l'aide du tableau.



31

Zone	Épaisseur de porte (mm)	Longueur du carré (mm)	Position de la bague
S	40 - 42	94	3
S	40 - 42	104	5
S	43 - 47	94	2
S	43 - 47	104	4
S	48 - 52	94	1
S	48 - 52	104	3
S	53 - 57	104	2
S	58 - 61	104	1
M	60 - 62	114	3
M	60 - 62	124	5
M	63 - 67	114	2
M	63 - 67	124	4
M	68 - 72	114	1
M	68 - 72	124	3
M	73 - 77	124	2
M	78 - 81	124	1
L	80 - 82	134	3
L	80 - 82	144	5
L	83 - 87	134	2
L	83 - 87	144	4
L	88 - 92	134	1
L	88 - 92	144	3
L	93 - 97	144	2
L	98 - 101	144	1
XL	100 - 184	Le joint torique se trouve à 30-35 mm de l'extrémité sciée du carré.	

18. Faites glisser le joint torique dans la rainure calculée.



32

19. Insérez le carré avec le côté sans bague dans la porte jusqu'à la butée.



33

20. Pour FH : Insérez le cylindre borgne.



NOTE

Guider le cylindre aveugle dans le trou avec un tournevis

Il est particulièrement difficile de positionner correctement le cylindre aveugle lorsque les portes sont épaisses.

1. Insérez un tournevis dans le trou du cylindre aveugle.
2. Positionnez le cylindre aveugle au moyen du tournevis.



34



35

21. Pour FH : Vissez le cylindre borgne (PH2, couple de serrage : 1,1 Nm).



36

22. Vissez l'unité de la béquille intérieure sur le carré (PH2, couple : 1,1 Nm).



37

23. Vissez la base de la rosace à l'intérieur (PH2, couple de serrage : 1,1 Nm).



38

24. Vissez les vis sans tête des deux béquilles (TX15, couple de serrage : 5,0 Nm).



39

25. Placez le blinde de la béquille intérieure sur la rosace de la béquille intérieure avec l'encoche vers le bas.



40

26. Insérez une blinde avec l'encoche vers le bas sur la base de la rosace.



41

- ↳ Le montage de la ferrure est terminé.

10. Démontage de la ferrure

- ✓ Clé à six pans 1,5 mm disponible.

1. Démontez la ferrure dans l'ordre inverse du montage.
2. Insérez une clé hexagonale de 1,5 mm dans le trou du carré conducteur de la ferrure.



42

3. Pliez la clé à six pans du côté où se trouve le trou et tirez simultanément sur la béquille extérieure.



43

- ↳ La ferrure est démontée.

11. Remplacement des piles



NOTE

Dysfonctionnements dus à un mauvais contact ou à une décharge différente

Des surfaces de contact trop petites/contaminées ou différentes batteries déchargées peuvent entraîner des dysfonctionnements.

- Utilisez uniquement des piles autorisées par la société SimonsVoss.
- Ne touchez pas les contacts des piles neuves avec les mains.
- Utilisez des gants propres et exempts de graisse.
- Remplacez toujours toutes les piles à la fois.

- ✓ Outil spécial présent.

- ✓ Gants présents.

1. Insérez l'outil spécial dans l'inlay du cache de protection de la ferrure.



44

2. Retirez le cache de protection à l'aide de l'outil.



45



46

3. Pliez délicatement le clip de la pile vers l'intérieur pour le décrocher.



47



48

4. Ouvrez le clip de la pile.



49

5. Retirez le clip de la pile.



50

6. Retirez les piles usagées.



51

7. Mettez les piles neuves en place avec les pôles positifs en contact (type CR2450).



52

8. Remettez le clip de la pile en place.



53

9. Enclenchez le clip de la pile.



54

10. Remettez le cache de protection en place sur la ferrure.



55

11. Remettez en place le clip du cache de protection.



56

- ↳ Les piles sont remplacées.

12. Données techniques

Plage de température (fonctionnement)	de -25 °C à +50 °C
Types de piles	4 × CR2450 (3 V)
Fabricant de pile	<ul style="list-style-type: none"> ■ Murata ■ Varta ■ Panasonic
Classe de protection IP	IP40

Émissions de radio

15,24 kHz - 72,03 kHz Seulement pour les numéros d'article : SV-S2.*A*, SV-S2.*AM*, SV-S2.*LN*	10 dBµA/m (3 m distance)
13,560006 MHz - 13,560780 MHz	1,04 dBµA/m (3 m distance)
868,000 MHz - 868,600 MHz / 869,700 MHz - 870,000 MHz Seulement pour les numéros d'article : SV-S2.*LN*, SI-S2.*M.WO*	<25 mW ERP
2402 MHz - 2480 MHz	2,5 mW

13. Déclaration de conformité

La société SimonsVoss Technologies GmbH déclare par la présente que les articles (SV-S2.*A*, SV-S2.*AM*, SV-S2.*LN*, SI-S2.*M.WO*, SI-S2.*M.VCN*) est conforme aux directives suivantes:

- 2014/53/EU -RED-
ou pour UK : UK statutory 2017 No. 1206 -Radio equipment-
(équipement radio)
- 2011/65/UE -RoHS-
ou pour UK : UK statutory 2012 No. 3032 -RoHS-



Le texte intégral de la déclaration de conformité CE est disponible à l'adresse Internet suivante : www.simons-voss.com/fr/certificats.html.
Le texte intégral de la déclaration de conformité UK est disponible à l'adresse Internet suivante : www.simons-voss.com/fr/certificats.html.

14. Aide et autres informations

Documentation/documents

<https://www.simons-voss.com/fr/documents.html>

<https://www.smartintego.com/fr/home/infocenter/documentations>

Déclarations de conformité

<https://www.simons-voss.com/fr/certificats.html>

Informations sur l'élimination

- Ne jetez pas l'appareil (SV-S2.*A*, SV-S2.*AM*, SV-S2.*LN*, SI-S2.*M.WO*, SI-S2.*M.VCN*) avec vos ordures ménagères mais dans un point de collecte communal pour appareils électriques et appareils spéciaux conformément à la directive européenne 2012/19/UE.
- Recyclez les piles défectueuses ou usées conformément à la directive européenne 2006/66/CE.
- Veuillez tenir compte des dispositions locales applicables concernant la collecte séparée des piles.
- Recyclez l'emballage d'une manière écologique.



57

E-Mail

support-simonsvoss@allegion.com

si-support-simonsvoss@allegion.com

SimonsVoss Technologies GmbH, Feringastr. 4, D-85774 Unterfoehring,
Allemagne

1. Beoogd gebruik

Bij de producten uit de SmartHandle AX-serie gaat het om elektronische deurbeslagen. Met behulp van een bevoegd identificatiemedium kan de SmartHandle AX activeren en de betreffende deur openen.

De bijbehorende rechten moeten met behulp van een elektronisch sluitplan worden toegewezen.

Producten uit de SmartHandle AX-serie mogen uitsluitend worden gebruikt voor het openen en sluiten van deuren. Een andersoortig gebruik is niet toegestaan.

2. Algemene veiligheidsinstructies

Signaalwoord: Mogelijke onmiddellijke gevolgen van niet-naleving

WAARSCHUWING: Dood of ernstig letsel (mogelijk, maar onwaarschijnlijk). **VOORZICHTIG:** Lichte letsel, LET OP: Materiele schade of storing, **OPMERKING:** Laag of nee



WAARSCHUWING

Geblokkeerde toegang

Door foutief geïnstalleerde en/of geprogrammeerde componenten kan de doorgang door een deur geblokkeerd blijven. Voor gevolgen van een geblokkeerde toegang tot gewonden of personen in gevaar, materiële of andere schade, is SimonsVoss Technologies GmbH niet aansprakelijk.

Geblokkeerde toegang als gevolg van manipulatie van het product

Als u het product zelf wijzigt, kunnen er storingen optreden en kan de toegang worden geblokkeerd door een deur.

- Vervang het product alleen wanneer dat nodig is en op de manier die in de documentatie wordt beschreven.

Batterijen niet inslikken. Verbrandingsgevaar door gevaarlijke stoffen

Dit product bevat lithium-knoopcellen. Als de knoopcel wordt ingeslikt, kunnen ernstige inwendige brandwonden optreden die binnen slechts twee uur de dood veroorzaken.

1. Houd nieuwe en gebruikte batterijen buiten bereik van kinderen.
2. Als het batterijvak niet goed sluit, mag u het product niet meer gebruiken en moet u het uit de buurt van kinderen houden.
3. Als u denkt dat batterijen zijn ingeslikt of in een ander lichaamsdeel terecht zijn gekomen, moet u onmiddellijk medische hulp inroepen.

Explosiegevaar door verkeerd type batterij

Het plaatsen van het verkeerde type batterij kan een explosie veroorzaken.

- Gebruik alleen de in de technische gegevens vermelde batterijen.



VOORZICHTIG

Brandgevaar door batterijen

De gebruikte batterijen kunnen bij verkeerde behandeling tot brand- of verbrandingsgevaar leiden.

1. Probeer niet de batterijen op te laden, open te maken, te verwarmen of te verbranden.
2. U mag de batterijen evenmin kortsluiten.

LET OP

Schade door elektrostatische ontlading (ESD) wanneer de behuizing open is

Dit product heeft elektronische componenten die kunnen worden beschadigd door een elektrostatische ontlading.

1. Maak gebruik van ESD-conforme materialen (bijv. aardingsarmband).
2. Zorg dat u geaard bent voor werkzaamheden waarbij u met de elektronica in contact kunt komen. Gebruik hiervoor geaarde metalen oppervlakken (bijv. Deurposten, waterleidingen of verwarmingsbuizen).

Beschadiging door vloeistoffen

Dit product heeft elektronische en/of mechanische componenten die kunnen worden beschadigd door elk type vloeistof.

- Houd vloeistoffen uit de buurt van de elektronica.

Beschadiging door bijtende reinigingsmiddelen

Het oppervlak van dit product kan worden beschadigd door ongeschikte reinigingsmiddelen.

- Maak uitsluitend gebruik van reinigingsmiddelen die geschikt zijn voor kunststof of metalen oppervlakken.

Beschadiging door mechanische impact

Dit product heeft elektronische componenten die kunnen worden beschadigd door elk type mechanische impact.

1. Vermijd dat u de elektronica aanraakt.
2. Vermijd ook andere mechanische impact op de elektronica.

Beschadiging door verwisseling van de polariteit

Dit product bevat elektronische componenten die door verwisseling van de polariteit van de voedingsbron beschadigd kunnen worden.

- Verwissel de polariteit van de voedingsbron niet (batterijen of netadapters).

Storing van het gebruik door verbroken verbinding

Dit product kan onder bepaalde omstandigheden beïnvloed worden door elektromagnetische of magnetische storingen.

- Monteer of plaats het product niet direct in de buurt van apparaten die elektromagnetische of magnetische storingen kunnen veroorzaken (stroomschakelaars).

Storing van de communicatie door metalen oppervlakken

Dit product communiceert draadloos. Metalen oppervlakken kunnen het zendbereik van het product aanzienlijk verminderen.

- Monteer of plaats het product niet op of in de buurt van metalen oppervlakken.



OPMERKING

Beoogd gebruik

SimonsVoss-producten zijn uitsluitend bedoeld voor het openen en sluiten van deuren en vergelijkbare voorwerpen.

- Gebruik SimonsVoss-producten niet voor andere doeleinden.

Storingen door slecht contact of verschillende ontladingen

Contactoppervlakken die te klein/vervuld zijn of verschillende ontladen accus kunnen leiden tot storingen.

1. Gebruik alleen batterijen die zijn vrijgegeven door SimonsVoss.
2. Raak de contacten van de nieuwe batterijen niet met de handen aan.
3. Gebruik schone, vetvrije handschoenen.
4. Vervang daarom alle batterijen tegelijk.

Afwijkende tijden bij G2-sluitelementen

De interne tijdeenheid van de G2-sluitelementen heeft een technisch bepaalde tolerantie van max. ± 15 minuten per jaar.

Kwaliteitsvereisten

De installatie en inbedrijfstelling vereist gespecialiseerde kennis. Alleen getraind personeel mag het product installeren en in bedrijf stellen.

Aanpassingen of nieuwe technische ontwikkelingen kunnen niet uitgesloten worden en worden gerealiseerd zonder aankondiging.

De Duitse taalversie is de originele handleiding. Andere talen (opstellen in de contracttaal) zijn vertalingen van de originele instructies.

Lees en volg alle installatie-, installatie- en inbedrijfstellingsinstructies. Geef deze instructies en eventuele onderhoudsinstructies door aan de gebruiker.

3. Specifieke veiligheidsinstructies per product

LET OP

Schade door boren

U boort op eigen risico. SimonsVoss Technologies GmbH is niet aansprakelijk voor schade veroorzaakt door het boren.

- Neem ook de veiligheidsinstructies van de boormachine in acht.

Schade veroorzaakt door ongeschikt gereedschap

Als u de koffer probeert te openen met ongeschikt gereedschap, kan de koffer beschadigd raken.

- Gebruik uitsluitend de meegeleverde SimonsVoss-openingsstool.

Verlies van precisie bij het bedienen van de deurkruk

De montage kan bij insteeksloten met klem een beetje moeilijk zijn.

- Bewerk de klem niet mechanisch. Anders functioneert de deurkruk niet meer precies.

Moelijke montage door onnauwkeurige boringen

Het beslag is niet monteerbaar wanneer de bevestigingsgaten en het vierkant niet bij elkaar passen.

- Zorg ervoor dat de bevestigingsgaten en het vierkant op een verticale lijn staan.

**OPMERKING****Effect op de inkepingsslot**

De SmartHandle AX werkt uitsluitend op de vergrendeling van het pennenslot.

Vergrendeling onder het verzekeringsrecht

Verzekeringsmaatschappijen stellen hogere eisen aan een sluiting.

- Als u de deur op grond van de verzekeringswetgeving wilt vergrendelen, gebruik dan naast de SmartHandle AX een zelfremmend paniekslot of een sluitcilinder.
- Let op de toelatingen volgens EN 179.

SmartHandle AX met zelfblokkerende paniekslot

De SmartHandle AX biedt alleen volledige functionaliteit met een zelfremmend paniekslot.

- Combineer de SmartHandle AX met een zelfremmend paniekslot.
- Let op de conformiteitsverklaringen van de slotfabrikanten volgens EN 179.

Voorwaarden voor machtigingszekerheid

Gebruik met Mifare Classic en/of PinCode keypad sluit autorisatie veiligheidsklasse D volgens DIN EN 16867:2020 uit.

Afsluiting van de rozetopening

Een evt. aanwezige rozetopening kan voor manipulaties worden gebruikt.

- Sluit evt. aanwezige rozetopeningen af, bijvoorbeeld met een blinde cilinder.
- Bij FH-varianten: monteer beslist een blind- of profielcilinder van mesing.

4. Leveromvang

- SmartHandle AX (Uitvoering met buisframe)
 - Speciaal gereedschap
 - Korte handleiding
- Voor FH-variant:
- Blindcilinder

5. Opbouw**6. Deur voorbereiden (boormal)**

- PH2-schroevendraaier beschikbaar.
- Pen of kraspen beschikbaar.
- een boormachine beschikbaar houden.
- Geschikte boor beschikbaar (Ø 7,2 mm).
- Verzinkboor beschikbaar.

- Steek het vierkant in het insteekslot.



- Plaats de boormal op het vierkant.



- Lijn de boormal verticaal uit met behulp van de opgedrukte schaalverdeling.

- Markeer de punten die geboord moeten worden op de deur.



- Verwijder de boorsjabloon.



- Verwijder het vierkant.



- Demonteer het insteekslot (PH2).



- Boor de benodigde gaten.



- Verzink de gaten met de verzinkboor zo ver, dat de blindklinkmoeren later vlak kunnen worden ingeprest.



- Bouw het insteekslot in (PH2).

**7. Voor deurdikte X: vierkant voorbereiden**

- Zaag aanwezig.
- Schuifmaat aanwezig.
- PH2-schroevendraaier beschikbaar.

- Voor X: meet de deurdikte.
- Voor X: markeer de zaagsnede op het vierkant.

**OPMERKING****Vierkant van 9 mm met uiteinde van 8 mm**

Het 9 mm vierkant heeft een 8 mm uiteinde. Dit uiteinde wordt in het elektrische beslag gestoken.

- Kort het vierkant van 9 mm zo in, dat het uiteinde van 8 mm zich niet in het afvalgedeelte bevindt.



- Voor X: kort het vierkant in met een geschikte zaag.

**8. Beslag programmeren**

Programmeer het beslag voor de montage. Afhankelijk van de productfamilie kunt u verschillende programmeerapparaten gebruiken.

**9. Beslag monteren**













- Deur voorgeboord.
- PH2-schroevendraaier beschikbaar.
- TX15-schroevendraaier beschikbaar.

- Plaats de meegeleverde blindklinkmoeren in het deurkozijn.





- Schroef de montageplaat aan de buitenzijde zo vast dat de veerklemmen naar de deur wijzen (PH2, draaimoment: 1,1 Nm).



3. Schroef de rozetbasis aan de buitenzijde vast (PH2, draaimoment: 1,1 Nm).
 19
4. Schroef de rozetbasis aan de binnenzijde vast (PH2, draaimoment: 1,1 Nm).
5. Steek het beslag in de uitsparingen van de montageplaat.
 20
6. Schuif het beslag in de montageplaat tot de aanslag naar beneden.
 21
7. Schroef het beslag vast op de montageplaat (PH1, draaimoment: 0,8 Nm).
 22
8. Steek een afdekking met de inkeping naar beneden op de rozetbasis.
 23
9. Steek de cover op het beslag.
 24
10. Steek de buitenklink op het beslag.
 25
11. Bepaal de gewenste draairichting van uw binnendeurkruk.
12. Breng het veerelement dienovereenkomstig aan.
13. Plaats de basis in de eenheid van de binnendeurkruk.
 26
 27
14. Voor 8,5 mm en 10 mm vierkant: schuif de adapterhuls in het midden van het vierkant. Maak met een centerpons en een hamer een verdiept punt in de adapterhuls om verschuiven te voorkomen.
 28
 29
15. Meet de totale lengte van de vierkantstift.
 30
16. Bepaal de binnenkant van de vierkantstift (uiteinde tot het midden van de eerste groef = 26 mm).
17. Bepaal de positie van de O-ring met behulp van de tabel.
 31

Bereik	Deurdikte (mm)	Lengte vierkantstift (mm)	Ringpositie
S	40 - 42	94	3
S	40 - 42	104	5
S	43 - 47	94	2
S	43 - 47	104	4
S	48 - 52	94	1
S	48 - 52	104	3
S	53 - 57	104	2
S	58 - 61	104	1
M	60 - 62	114	3
M	60 - 62	124	5
M	63 - 67	114	2
M	63 - 67	124	4
M	68 - 72	114	1
M	68 - 72	124	3
M	73 - 77	124	2
M	78 - 81	124	1
L	80 - 82	134	3
L	80 - 82	144	5
L	83 - 87	134	2
L	83 - 87	144	4
L	88 - 92	134	1
L	88 - 92	144	3
L	93 - 97	144	2
L	98 - 101	144	1
XL	100 - 184	De O-ring ligt op 30-35 mm van het afgezaagde uiteinde van de vierkantstift.	

18. Schuif de O-ring op de berekende groef.
 32
19. Steek het vierkant met de kant zonder ring tot de aanslag in de deur.
 33
20. Voor FH: breng de blinde cilinder aan.





OPMERKING

Blinde cilinder met schroevendraaier in het gat leiden

In het bijzonder bij dikke deuren is het moeilijk om de blinde cilinder correct te positioneren.

1. Steek een schroevendraaier in het gat van de blinde cilinder.
2. Positioneer de blinde cilinder met behulp van de schroevendraaier.



21. Voor FH: schroef de blinde cilinder vast (PH2, draaimoment: 1,1 Nm).
 36
22. Schroef de binnenklinkenheid op het vierkant (PH2, draaimoment: 1,1 Nm).
 37
23. Schroef de rozetbasis aan de binnenzijde vast (PH2, draaimoment: 1,1 Nm).
 38

24. Schroef de stifttappen van beide deurkrukken vast (TX15, draaimoment: 5,0 Nm).



39

25. Steek de afdekking van de binnenklink met de inkeping naar beneden op de rozet van de binnenklink.



40

26. Steek een afdekking met de inkeping naar beneden op de rozetbasis.



41

↳ Beslag is gereed gemonteerd.

10. Beslag demonteren

✓ 1,5 mm inbusleutel beschikbaar.

1. Demonteer het beslag in omgekeerde volgorde van de montage.

2. Steek een inbusleutel van 1,5 mm in het gat van de opname voor de vierkantstift in het beslag.



42

3. Buig de inbusleutel naar de zijde waar het gat zich bevindt en trek tegelijkertijd aan de buitendeurkruk.



43

↳ Beslag is gedemonteerd.

11. Batterijen vervangen



OPMERKING

Storingen door slecht contact of verschillende ontladingen

Contactoppervlakken die te klein/vervuld zijn of verschillende ontladen accu's kunnen leiden tot storingen.

- Gebruik alleen batterijen die zijn vrijgegeven door SimonsVoss.
- Raak de contacten van de nieuwe batterijen niet met de handen aan.
- Gebruik schone, vetvrije handschoenen.
- Vervang daarom alle batterijen tegelijk.

- ✓ Speciaal gereedschap beschikbaar.
- ✓ Handschoenen aanwezig.

1. Steek het speciale gereedschap in de cover-inlay van het beslag.



44

2. Verwijder de cover met het gereedschap.



45



46

3. Buig de batterijklem voorzichtig naar binnen om hem los te maken.



47



48

4. Open de batterijklem.



49

5. Trek de batterijklem eruit.



50

6. Verwijder de oude batterijen.



51

7. Zet de nieuwe batterijen in met de pluspolen tegen elkaar (type CR2450).



52

8. Zet de batterijklem er weer in.



53

9. Haak de batterijklem weer vast.



54

10. Plaats de cover weer op het beslag.



55

11. Klik de cover weer vast.



56

↳ De batterijen zijn vervangen.

12. Technische gegevens

Temperatuurbereik (bedrijf)	-25°C tot +50°C
Soort batterij	4 × CR2450 (3V)
Batterijmerk	<ul style="list-style-type: none"> ■ Murata ■ Varta ■ Panasonic
IP-beschermingsklasse	IP40

Radio-emissies

15,24 kHz - 72,03 kHz Alleen voor artikelnummers: SV-S2.*A*, SV-S2.*AM*, SV-S2.*LN*	10 dBµA/m (3 m afstand)
13,560006 MHz - 13,560780 MHz	1,04 dBµA/m (3 m afstand)
868,000 MHz - 868,600 MHz / 869,700 MHz - 870,000 MHz Alleen voor artikelnummers: SV-S2.*LN*, SI-S2.*M.WO*	<25 mW ERP
2402 MHz - 2480 MHz	2,5 mW

13. Verklaring van overeenstemming

Het bedrijf SimonsVoss Technologies GmbH verklaart dat de artikelen (SV-S2.*A*, SV-S2.*AM*, SV-S2.*LN*, SI-S2.*M.WO*, SI-S2.*M.VCN*) voldoen aan de volgende richtlijnen:

- 2014/53/EU -RED-
of voor de UK: UK wettelijk 2017 Nr. 1206 -Radioapparatuur-
- 2011/65/EU -RoHS-
of voor de UK: UK wettelijk 2012 Nr. 3032 -RoHS-



De volledige tekst van de EU-conformiteitsverklaring is beschikbaar op het volgende internetadres: www.simons-voss.com/nl/certificaten.html. De volledige tekst van de UK-conformiteitsverklaring is beschikbaar op het volgende internetadres: www.simons-voss.com/nl/certificaten.html.

14. Hulp en verdere informatie

Informatiemateriaal/documenten

<https://www.simons-voss.com/nl/documenten.html>

<https://www.smartintego.com/int/home/infocenter/documentation>

Conformiteitsverklaringen

<https://www.simons-voss.com/nl/certificaten.html>

Informatie over verwijdering

- Voer het apparaat (SV-S2.*A*, SV-S2.*AM*, SV-S2.*LN*, SI-S2.*M.WO*, SI-S2.*M.VCN*) niet af als huishoudelijk afval, maar overeenkomstig de Europese Richtlijn 2012/19/EU bij een gemeentelijke inzamelingspunt voor speciaal elektrotechnisch afval.
- Zorg voor recycling van defecte of gebruikte batterijen volgens de Europese Richtlijn 2006/66/EG.
- Neem de plaatselijke bepalingen in acht voor de gescheiden afvoer van batterijen.
- Voer de verpakking af naar een instantie voor milieuvriendelijke recycling.



57

E-mail

support-simonsvoss@allegion.com

si-support-simonsvoss@allegion.com

SimonsVoss Technologies GmbH, Feringastr. 4, 85774 Unterföhring,
Duitsland

1. Uso conforme

I prodotti della serie SmartHandle AX sono maniglie elettroniche. Con l'ausilio di un mezzo di identificazione autorizzato SmartHandle AX può innestarsi e aprire la porta corrispondente.

Le relative autorizzazioni devono essere rilasciate con l'ausilio di un piano di chiusura elettronico.

I prodotti della serie SmartHandle AX possono essere utilizzati solo per l'apertura e la chiusura delle porte. Qualsiasi altro uso non è consentito.

2. Avvisi di sicurezza generali

Parola segnale: Possibili effetti immediati di non conformità

AVVERTENZA: Morte o lesioni gravi (possibili, ma improbabili), **ATTENZIONE:** Lesione minori, **AVVISO:** Danni materiali o malfunzionamento, **NOTA:** Basso o no



AVVERTENZA

Accesso bloccato

Con componenti montati e/o programmati in modo difettoso, l'accesso attraverso una porta può restare bloccato. La SimonsVoss Technologies GmbH non risponde delle conseguenze di un accesso bloccato, per esempio nel caso si debba accedere a persone ferite o in pericolo, di danni a cose o altri danni!

Accesso bloccato tramite manipolazione del prodotto

Se si modifica il prodotto da solo, possono verificarsi malfunzionamenti e l'accesso attraverso una porta può essere bloccato.

- Modificare il prodotto solo quando necessario e solo nel modo descritto nella documentazione.

Non ingerire la batteria. Pericolo di ustioni dovute a sostanze pericolose

Questo prodotto contiene batterie a bottone al litio. Se la batteria a bottone viene inghiottita, possono verificarsi gravi ustioni interne nel giro di sole due ore che possono causare la morte.

1. Conservare le batterie nuove e usate lontano dalla portata dei bambini.
2. Se il vano batteria non si chiude in modo sicuro, interrompere l'uso del prodotto e tenerlo lontano dalla portata dei bambini.
3. Se pensate che le batterie siano state inghiottite o si trovino in una qualsiasi parte del vostro corpo, rivolgetevi immediatamente a un medico.

Pericolo di esplosione a causa di un tipo di batteria non corretto

L'inserimento del tipo di batteria sbagliato può causare un'esplosione.

- Utilizzare solo le batterie specificate nei dati tecnici.



ATTENZIONE

Pericolo di incendio dovuto alle batterie

Le batterie utilizzate possono costituire un pericolo di incendio o combustione in caso di utilizzo scorretto.

1. Non tentare di caricare, aprire, riscaldare o bruciare le batterie.
2. Non cortocircuitare le batterie.

AVVISO

Danni dovuti a scariche elettrostatiche (ESD) quando l'alloggiamento è aperto

Il presente prodotto contiene componenti elettronici che potrebbero subire danni in conseguenza di scariche elettrostatiche.

1. Utilizzare materiali di lavori conformi ai requisiti ESD (ad es. fascetta antistatica al polso).
2. Effettuare la messa a terra dell'operatore prima di eseguire lavori in cui è possibile entrare in contatto con parti elettroniche. A tale scopo, toccare una superficie metallica opportunamente messa a terra (ad es. telaio porta, tubi dell'acqua o valvole di riscaldamento).

Danni dovuti a fluidi

Il presente prodotto contiene componenti elettronici e/o meccanici che potrebbero subire danni dovuti a liquidi di qualunque tipo.

- Tenere i componenti elettronici lontani da liquidi.

Danni dovuti a detergenti aggressivi

La superficie di questo prodotto può essere danneggiata da detergenti non idonei.

- Utilizzare esclusivamente detergenti adatti a superfici in plastica o metallo.

Danni dovuti a effetti meccanici

Il presente prodotto contiene componenti elettronici che potrebbero subire danni dovuti a effetti meccanici di qualunque tipo.

1. Evitare di toccare le parti elettroniche.
2. Evitare ulteriori effetti meccanici sulle parti elettroniche.

Danni dovuti all'inversione di polarità

Questo prodotto contiene componenti elettronici che possono essere danneggiati dall'inversione di polarità della sorgente di tensione.

- Non invertire la polarità della sorgente di tensione (batterie o alimentatori).

Funzionamento disturbato a causa di interferenze radioelettriche

Questo prodotto potrebbe essere influenzato da disturbi elettromagnetici o magnetici.

- Non montare o posizionare il prodotto direttamente accanto a dispositivi che possono causare interferenze elettromagnetiche o magnetiche (alimentatori switching!).

Interferenze nella comunicazione dovute a superfici metalliche

Questo prodotto comunica in modalità wireless. Le superfici metalliche possono ridurre significativamente la portata del prodotto.

- Non montare o posizionare il prodotto sopra o vicino a superfici metalliche.



NOTA

Uso conforme

I prodotti SimonsVoss sono concepiti esclusivamente per l'apertura e la chiusura di porte e oggetti simili.

- Non utilizzare i prodotti SimonsVoss per altri scopi.

Malfunzionamenti dovuti a contatto insufficiente o a scarichi diversi

Superfici di contatto troppo piccole/contaminate o diverse batterie scariche possono portare a malfunzionamenti.

1. Utilizzare esclusivamente batterie autorizzate da SimonsVoss.
2. Non toccare con le mani i contatti delle nuove batterie.
3. Utilizzare guanti puliti e privi di grasso.
4. Sostituire sempre tutte le batterie contemporaneamente.

Tempi diversi per chiusure G2

L'unità temporale interna delle chiusure G2 è tecnicamente vincolata a una tolleranza fino a ± 15 minuti all'anno.

Qualifiche richieste

L'installazione e la messa in servizio richiedono conoscenze specialistiche.

- Solo personale qualificato può installare e mettere in servizio il prodotto.

Non si escludono modifiche o perfezionamenti tecnici, anche senza preavvisi.

La versione in lingua tedesca è il manuale di istruzioni originale. Altre lingue (redazione nella lingua del contratto) sono traduzioni delle istruzioni originali.

Leggere e seguire tutte le istruzioni di installazione, installazione e messa in servizio. Passare queste istruzioni e tutte le istruzioni di manutenzione all'utente.

3. Avvertenze di sicurezza specifiche del prodotto

AVVISO

Danni da perforazione

Esercitate a vostro rischio e pericolo. SimonsVoss Technologies GmbH non è responsabile dei danni causati dalla perforazione.

- Osservare anche le norme di sicurezza del trapano.

Danni causati da utensili non idonei

Se si tenta di aprire la custodia con strumenti inadeguati, la custodia può essere danneggiata.

- Utilizzare solo l'utensile di apertura SimonsVoss in dotazione.

La maniglia non ha più una guida precisa

In caso di serrature ad incasso dotate di perno di riscontro, il montaggio della SmartHandle può risultare leggermente difficoltoso.

- Non modificare meccanicamente il perno di riscontro, poiché altrimenti la maniglia non avrà più una guida precisa.

Montaggio difficoltoso a causa di fori imprecisi

La maniglia non si può montare, quando i fori di fissaggio e il quadro maniglia non combaciano.

- Assicurarsi che i fori di fissaggio e il quadro maniglia si trovino su una linea verticale.



NOTA

Effetto sulla serratura da infilare

SmartHandle AX agisce esclusivamente sullo scrocco della serratura da infilare.

Blocco secondo la legge sulle assicurazioni

Le compagnie di assicurazione pongono maggiori richieste di chiusura.

- Se si desidera chiudere la porta secondo la legge sull'assicurazione, oltre alla SmartHandle AX si può utilizzare una serratura antipanico autobloccante o un cilindro di chiusura.
- Prestare attenzione alle omologazioni secondo EN 179.

SmartHandle AX con serratura antipanico autobloccante

SmartHandle AX offre tutte le funzionalità solo con una serratura antipanico autobloccante.

- Combinare l'SmartHandle AX con una serratura antipanico autobloccante.
- Prestare attenzione alle dichiarazioni di conformità dei produttori di serrature secondo EN 179.

Condizioni per la sicurezza dell'autorizzazione

Il funzionamento con la tastiera Mifare Classic e/o PinCode esclude la classe di sicurezza di autorizzazione D secondo la norma DIN EN 16867:2020.

Chiusura dell'apertura delle rosette

Per le manipolazioni è possibile utilizzare l'apertura delle rosette ev. presenti.

- Chiudere le aperture delle rosette ev. presenti, ad esempio con un cilindro cieco.
- Per le varianti FH: installare obbligatoriamente un cilindro cieco o di chiusura in ottone.

4. Oggetto di fornitura

- SmartHandle AX (variante telaio tubolare)
- Attrezzo speciale
- Libretto di istruzioni

Per la variante FH:

- Cilindro cieco

5. Struttura



6. Preparazione della porta (maschera di foratura)

- ✓ Cacciavite PH2 a disposizione.
- ✓ Perno o punta per tracciare a disposizione.
- ✓ Trapano a disposizione.
- ✓ Punta adatta a disposizione (Ø 7,2 mm).
- ✓ Svasatore conico a disposizione.

- Inserire il quadro maniglia nella serratura a incasso.



- Applicare la maschera di foratura sul quadro maniglia.



- Allineare la maschera di foratura in verticale con l'ausilio della scala graduata.

- Segnare i punti da forare sulla porta.



- Rimuovere la maschera di foratura.



- Rimuovere il quadro maniglia.



- Rimuovere la serratura a incasso (PH2).



- Praticare i fori necessari.



- Allargare i fori con lo svasatore conico, in modo che i dadi a rivetto cieco, successivamente, possano essere inseriti a pressione a filo.



- Inserire la serratura a incasso (PH2).



-

7. Per lo spessore della porta X: preparazione del quadro maniglia

- ✓ Sega a disposizione.
- ✓ Calibro a disposizione.
- ✓ Cacciavite PH2 a disposizione.

- Per X: misurare lo spessore della porta.
- Per X: contrassegnare il punto da segare sul quadro maniglia.



NOTA

Quadro maniglia di 9 mm con estremità di 8 mm

Il quadro maniglia di 9 mm ha un'estremità di 8 mm. L'estremità è inserita nella maniglia elettronica.

- Accorciare il quadro maniglia di 9 mm, in modo che l'estremità di 8 mm non si trovi nella parte di scarto.



- Per X: accorciare il quadro maniglia con una sega adatta.



8. Programmare la maniglia

Programmare la maniglia prima del montaggio. È possibile utilizzare diversi dispositivi di programmazione a seconda della famiglia di prodotti.





16

9. Montaggio della maniglia

- ✓ Porta già forata.
- ✓ Cacciavite PH2 a disposizione.
- ✓ Cacciavite TX15 a disposizione.

1. Inserire i dadi a rivetto cieco in dotazione nel telaio della porta.



17

2. Avvitare saldamente la piastra di montaggio sul lato esterno, in modo che i morsetti a molla siano rivolti verso la porta (PH2, coppia: 1,1 Nm).



18

3. Avvitare saldamente il portarosetta sul lato esterno (PH2, coppia: 1,1 Nm).



19

4. Avvitare saldamente il portarosetta sul lato interno (PH2, coppia: 1,1 Nm).

5. Inserire la maniglia nell'alloggiamento della piastra di montaggio.



20

6. Spingere la maniglia verso il basso nella piastra di montaggio, fino all'arresto.



21

7. Avvitare saldamente la maniglia nella piastra di montaggio (PH1, coppia: 0,8 Nm).



22

8. Applicare una copertura con la tacca rivolta verso il basso sul portarosetta.



23

9. Applicare la cover sulla maniglia.



24

10. Applicare la maniglia esterna sulla maniglia.



25

11. Stabilire il senso di rotazione desiderato della maniglia interna.

12. Inserire l'elemento a molla correttamente.

13. Inserire la piastrina nell'unità della maniglia interna.



26



27

14. Per il quadro maniglia di 8,5 mm e di 10 mm: spingere il manicotto adattatore al centro del quadro maniglia. Con un martello e un punzone realizzare un incavo nel manicotto adattatore per impedire che si muova.



28



29

15. Misurare la lunghezza complessiva del quadro maniglia.



30

16. Rilevare il lato interno del quadro maniglia (dall'estremità del quadro maniglia al centro della prima scanalatura = 26 mm).

17. Determinare la posizione dell'O-ring con la tabella.



31

Area	Spessore porta (mm)	Lunghezza quadro maniglia (mm)	Posizione anello
S	40 - 42	94	3
S	40 - 42	104	5
S	43 - 47	94	2
S	43 - 47	104	4
S	48 - 52	94	1
S	48 - 52	104	3
S	53 - 57	104	2
S	58 - 61	104	1
M	60 - 62	114	3
M	60 - 62	124	5
M	63 - 67	114	2
M	63 - 67	124	4
M	68 - 72	114	1
M	68 - 72	124	3
M	73 - 77	124	2
M	78 - 81	124	1
L	80 - 82	134	3
L	80 - 82	144	5
L	83 - 87	134	2
L	83 - 87	144	4
L	88 - 92	134	1
L	88 - 92	144	3
L	93 - 97	144	2
L	98 - 101	144	1
XL	100 - 184	L'O-ring si trova a 30-35 mm dall'estremità segata del quadro maniglia.	

18. Far scorrere l'O-ring sulla scanalatura calcolata.



32

19. Inserire il lato senza l'anello del quadro maniglia nella porta finché non si arresta.



33

20. Per FH: inserire il cilindro cieco.



NOTA

Posizionare il cilindro cieco nel foro utilizzando il cacciavite

Soprattutto per le porte di grande spessore, è difficile posizionare correttamente il cilindro cieco.

1. Inserire un cacciavite nel foro del cilindro cieco.
2. Posizionare il cilindro cieco con l'ausilio del cacciavite.



34



35

21. Per FH: avvitare saldamente il cilindro cieco (PH2, coppia: 1,1 Nm).



36

22. Avvitare l'unità della maniglia interna sul quadro maniglia (PH2, coppia: 1,1 Nm).



37

23. Avvitare saldamente il portarosetta sul lato interno (PH2, coppia: 1,1 Nm).



38

24. Avvitare saldamente la vite senza testa di entrambe le maniglie (TX15, coppia: 5,0 Nm).



25. Applicare la copertura della maniglia interna con la tacca rivolta verso il basso sulla rosetta della maniglia interna.



26. Applicare una copertura con la tacca rivolta verso il basso sul portarosetta.



- ↳ La maniglia è completamente montata.

10. Smontaggio della maniglia

- ✓ Chiave esagonale da 1,5 mm disponibile.

1. Smontare la maniglia procedendo nella sequenza opposta rispetto al montaggio.
2. Inserire una chiave esagonale da 1,5 mm nel foro dell'alloggiamento del quadro maniglia nella maniglia.



3. Girare la chiave esagonale dal lato sul quale si trova il foro e contemporaneamente tirare la maniglia esterna.



- ↳ La maniglia è smontata.

11. Sostituzione delle batterie



NOTA

Malfunzionamenti dovuti a contatto insufficiente o a scarichi diversi

Superfici di contatto troppo piccole/contaminate o diverse batterie scariche possono portare a malfunzionamenti.

- Utilizzare esclusivamente batterie autorizzate da SimonsVoss.
- Non toccare con le mani i contatti delle nuove batterie.
- Utilizzare guanti puliti e privi di grasso.
- Sostituire sempre tutte le batterie contemporaneamente.

- ✓ Attrezzo speciale a disposizione.
✓ Guanti a disposizione.

1. Inserire l'attrezzo speciale nell'inserto della cover della maniglia.



2. Togliere la cover con l'attrezzo.



3. Piegare con cautela il morsetto della batteria verso l'interno, per sganclarlo.



4. Aprire il morsetto della batteria.



5. Estrarre il morsetto della batteria.



6. Rimuovere le vecchie batterie.



7. Inserire le batterie nuove in modo tale che i poli positivi si tocchino (tipo CR2450).



8. Reinserire la maniglia.



9. Agganciare nuovamente il morsetto della batteria.



10. Applicare nuovamente la cover sulla maniglia.



11. Reintegrare saldamente la cover.



- ↳ Le batterie sono sostituite.

12. Dati tecnici

Range di temperature (esercizio)	da -25 °C a +50 °C
Tipo di batteria	4 × CR2450 (3V)
Marca delle batterie	<ul style="list-style-type: none"> ■ Murata ■ Varta ■ Panasonic
Grado di protezione	IP40

Emissioni radio

15,24 kHz - 72,03 kHz Solo per i codici articolo: SV-S2.*A*, SV-S2.*AM*, SV-S2.*LN*	10 dBµA/m (3 m distanza)
13,560006 MHz - 13,560780 MHz	1,04 dBµA/m (3 m distanza)
868,000 MHz - 868,600 MHz / 869,700 MHz - 870,000 MHz Solo per i codici articolo: SV-S2.*LN*, SI-S2.*M.WO*	<25 mW ERP
2402 MHz - 2480 MHz	2,5 mW

13. Dichiarazione di conformità

Het bedrijf SimonsVoss Technologies GmbH verklaart hierbij dat de artikelen (SV-S2.*A*, SV-S2.*AM*, SV-S2.*LN*, SI-S2.*M.WO*, SI-S2.*M.VCN*) voldoet aan de volgende richtlijnen:

- 2014/53/UE - RED-
o per il Regno Unito: Normativa del Regno Unito 2017 n. 1206
-Apparecchiature radio-
- 2011/65/UE -RoHS-
o per il Regno Unito: Normativa del Regno Unito 2012 n. 3032 -RoHS-



Il testo integrale della dichiarazione di conformità UE è disponibile al seguente indirizzo Internet: www.simons-voss.com/it/certificati.html.
Il testo integrale della dichiarazione di conformità UK è disponibile al seguente indirizzo Internet: www.simons-voss.com/it/certificati.html.

14. Supporto e ulteriori informazioni

Materiale informativo/Documents

<https://www.simons-voss.com/it/documenti.html>

<https://www.smartintego.com/int/home/infocenter/documentation>

Dichiarazioni di conformità

<https://www.simons-voss.com/it/certificati.html>

Informazioni sullo smaltimento

- Il dispositivo (SV-S2.*A*, SV-S2.*AM*, SV-S2.*LN*, SI-S2.*M.WO*, SI-S2.*M.VCN*) non va smaltito fra i rifiuti domestici, ma conferito presso un centro di raccolta comunale per rifiuti elettronici speciali in conformità con la Direttiva Europea 2012/19/UE.
- Riciclare le batterie guaste o esauste ai sensi della Direttiva Europea 2006/66/CE.
- Osservare le disposizioni locali in materia di smaltimento speciale delle batterie.
- Conferire l'imballaggio presso un punto di raccolta ai fini del riciclaggio ecologico.



57

E-mail

support-simonsvoss@allegion.com

si-support-simonsvoss@allegion.com

SimonsVoss Technologies GmbH, Feringastr. 4, D-85774 Unterfoehring,
Germany

1. Anvendelsesområder

Ved SmartHandle AX-seriens produkter drejer det sig om elektroniske dørbeslag. SmartHandle AX kan koble ind og åbne den pågældende dør ved hjælp af et adgangsberegtiget identifikationsmedium.

Tilsvarende adgangsrrettigheder skal deles af en elektronik låseplan.

SmartHandle AX-seriens produkter må kun bruges til åbning og lukning af døre. Anden anvendelse er ikke tilladt.

2. Generelle sikkerhedshenvisninger

Signalord: Mulige direkte virkninger i tilfælde af manglende overholdelse

ADVARSEL: Død eller alvorlig personskade (muligt, men usandsynligt), FOR-

SIGTIG: Mindre skade, OPMÆRKSOMHED: Materiel skade eller fejlfunktion,

BEMÆRK: Lidt eller ingen



ADVARSEL

Spærret adgang

Hvis komponenter er fejlagtigt monteret og/eller programmeret, kan adgang til en dør forblive spærret. For følgeskader, der skyldes spærret adgang, fx til personer, der er sårede eller i fare, tingskader eller andre skader, hæfter SimonsVoss Technologies GmbH ikke!

Blokeret adgang gennem manipulation af produktet

Hvis du selv ændrer produktet, kan der opstå funktionsfejl, og adgang via en dør kan blokeres.

- Modificer kun produktet, når det er nødvendigt, og kun på den måde, der er beskrevet i dokumentationen.

Batteri må ikke indtages. Forbrændingsfare på grund af farlige stoffer

Dette produkt indeholder lithium-knappceller. Hvis knapcellen sluges, kan det medføre alvorlige indre forbrændinger inden for to timer og dødsfald.

1. Opbevar nye og brugte batterier uden for børns rækkevidde.
2. Hvis batterirummet ikke kan lukkes ordentligt, må produktet ikke længere benyttes, og det opbevares uden for børns rækkevidde.
3. Hvis du tror, at batterier er blevet slugt eller befinder sig i en legemsdel, skal du straks søge lægehjælp.

Eksplisionsfare på grund af forkert batteritype

Isætning af den forkerte batteritype kan resultere i en eksplosion.

- Brug kun de batterier, der er specificeret i de tekniske data.



FORSIGTIG

Brandfare ved batterier

Batterierne kan udgøre en brand- eller forbrændingsfare ved forkert behandling.

1. Forsøg ikke at oplade, åbne, opvarme eller brænde batterierne.
2. Kortslut ikke batterierne.

OPMÆRKSOMHED

Beskadigelse på grund af elektrostatisk afladning (ESD) med huset åbent

Dette produkt indeholder elektroniske komponenter, som kan blive beskadiget på grund af elektrostatisk afladning.

1. Brug ESD-beskyttede arbejdsmaterialer (f.eks. jordforbindelsesbånd).
2. Opret jordforbindelse før arbejde, hvor du kan komme i kontakt med elektronikken. Indfat i denne forbindelse jordforbundne metaloverflader (f.eks. dørarme, vandør eller varmeventiler).

Beskadigelse på grund af væske

Dette produkt indeholder elektroniske og/eller mekaniske komponenter, som kan blive beskadiget på grund af alle typer væsker.

- Hold væsker væk fra elektronikken.

Beskadigelse på grund af aggressive rengøringsmidler

Produktets overflade kan blive beskadiget på grund af uegnede rengøringsmidler.

- Brug kun rengøringsmidler, der er velegnede til kunststof- og metaloverflader.

Beskadigelse på grund af mekanisk påvirkning

Dette produkt indeholder elektroniske komponenter, som kan blive beskadiget på grund af alle typer mekanisk påvirkning.

1. Undgå at berøre elektronikken.
2. Undgå at udsætte elektronikken for andre mekaniske påvirkninger.

Beskadigelse på grund af fejltilslutning

Dette produkt indeholder elektroniske komponenter, som kan blive beskadiget på grund af fejltilslutning af spændingskilden.

- Sørg for ikke at fejltilslutte spændingskilden (batterier eller netdele).

Driftsforstyrrelse på grund af radiostøj

Dette produkt kan under visse omstændigheder påvirkes af elektromagnetiske eller magnetiske forstyrrelser.

- Monter eller anbring ikke produktet umiddelbart i nærheden af enheder, som kan medføre elektromagnetiske eller magnetiske forstyrrelser (strømforsyninger!).

Kommunikationsfejl på grund af metaloverflader

Dette produkt kommunikerer trådløst. Metaloverflader kan reducere produktets rækkevidde væsentligt.

- Monter eller anbring ikke produktet på eller i nærheden af metaloverflader.



BEMÆRK

Korrekt anvendelse

SimonsVoss-produkter er kun beregnet til åbning og lukning af døre og sammenlignelige genstande.

- Anvend ikke SimonsVoss-produkter til andre formål.

Funktionsfejl på grund af dårligt kontakt eller anden afladning

For små / forurenede kontaktområder eller forskellige afladede batterier kan føre til funktionsfejl.

1. Anvend kun batterier, som er frigivet af SimonsVoss.
2. Berør ikke de nye batteriers kontakter med hænderne.
3. Anvend rene og fedtfrie handsker.
4. Skift derfor altid alle batterier samtidigt.

Afvigende tidspunkter ved G2-lukninger

Den interne tidsenhed ved G2-lukninger har en teknisk betinget tolerance på op til ± 15 minutter om året.

Krævede kvalifikationer

Installation og driftsættelse kræver specialiseret viden.

- Kun uddannet personale må installere og driftsætte produktet.

Ændringer eller tekniske videreudviklinger kan ikke udelukkes og kan foretages uden forudgående varsel.

Den tyske sprogversion er den originale brugsanvisning. Andre sprog (udkast på kontrakt sproget) er oversættelser af de originale instruktioner.

Læs og følg alle installations-, installations- og driftsættelsesinstruktioner. Overfør disse instruktioner og eventuel vedligeholdelsesinstruktion til brugeren.

3. Produktspecifikke sikkerhedsanvisninger

OPMÆRKSOMHED

Skade ved boring

De borer på egen risiko. For skader forårsaget af boring er SimonsVoss Technologies GmbH ikke ansvarlig.

- Overhold også borens sikkerhedsinstruktioner.

Skader på grund af uegnet værktøj

Forsøg på at åbne sagen med et forkert værktøj kan beskadige sagen.

- Brug kun det medfølgende SimonsVoss åbningsværktøj.

Tab af præcis føring af håndtag

Montagen kan være stram ved indstikslåse med låsekasse.

- Låsekassen må ikke bearbejdes mekanisk. Håndtaget mister sin nøjagtige føring.

Vanskelig montering på grund af uøjagtige borehuller

Beslaget kan ikke monteres, hvis monteringshullerne og firkanten ikke passer sammen.

- Sørg for, at monteringshullerne og firkanten er på en lodret linje.



BEMÆRK

Effekt på indlåsningsslåsen

SmartHandle AX fungerer udelukkende på låsen på låseåbningen.

Lukningsforsikringslov

Forsikringselskaber stiller større krav til lukning.

- Hvis du vil lukke døren under forsikringsloven, skal du bruge en selvlåsende paniklås eller en låsecylinder ud over SmartHandle AX.
- Vær opmærksom på godkendelserne i henhold til EN 179.

SmartHandle AX med selvlåsende paniklås

SmartHandle AX tilbyder kun fuld funktionalitet med en selvlåsende paniklås.

- Kombiner SmartHandle AX med en selvlåsende paniklås.
- Vær opmærksom på låsefabrikantens overensstemmelseserklæringer i henhold til EN 179.

Betingelser for sikkerhedsstillelse i forbindelse med tilladelsen

Drift med Mifare Classic- og/eller PinCode-tastatur udelukker autorisation sikkerhedsklasse D i henhold til DIN EN 16867:2020.

Lukning af rosetåbning

En evt. eksisterende åbning i rosetten kan bruges til manipulationer.

- Luk evt. eksisterende åbninger i rosetten, f.eks. med en blindcylinder.
- Ved FH-varianten: Det er vigtigt at montere en blindcylinder eller låsecylinder af messing.

4. Leveringsomfang

- SmartHandle AX (rørramme-variant)

- Specialværktøj

- Kort vejledning

For FH-varianten:

- Blindcylinder

5. Montering



6. Forbered døren (boreskabelon)

- PH2-skruetrækker til rådighed.
- Blyant eller ridsenål til stede.
- Boremaskine til rådighed.

- Der er et passende bor (Ø 7,2 mm) til rådighed.
- Konusforsænker tilgængelig.

- Sæt firkanten ind i indstikslåsen.



- Sæt boreskabelonen på firkanten.



- Juster boreskabelonen lodret ved hjælp af den påtrykte skala.

- Markér de punkter, der skal bores på døren.



- Fjern boreskabelonen.



- Fjern firkanten.



- Afmonter indstikslåsen (PH2).



- Bor de nødvendige huller.



- Forsænk hullerne med konusforsænkeren, så blindnetmøtrikkerne senere kan presses ind i niveau.



- Monter indstikslåsen (PH2).



7. For dørtykkelse X: Forbered firkanten

- Sav til rådighed.
- Skydelære til rådighed.
- PH2-skruetrækker til rådighed.

- For X: Mål tykkelsen på døren.



- For X: Markér savpunktet på firkanten.



BEMÆRK

9 mm-firkant med 8 mm-ende

9 mm-firkanten har en ende på 8 mm. Denne ende sættes ind i det elektroniske beslag.

- Afkort 9 mm-firkanten, så 8 mm-enden ikke er i affaldsdelen.



- For X: Afkort firkanten med en egnet sav.



8. Programmering af beslag

Programmér beslaget før montering. Afhængigt af produktfamilien kan du bruge forskellige programmeringsenheder.

















9. Monter beslaget



- Døren er forboret.
- PH2-skruetrækker til rådighed.
- TX15-skruetrækker til rådighed.

- Indsæt de medfølgende blindnetmøtrikker i dørkarmen.



2. Skru monteringspladen fast på ydersiden, så fjederklemmerne vender ind mod døren (PH2, drejningsmoment: 1,1 Nm).
 18
3. Skru rosetbasen fast på ydersiden (PH2, drejningsmoment: 1,1 Nm).
 19
4. Skru rosetbasen fast på indersiden (PH2, drejningsmoment: 1,1 Nm).
5. Sæt beslaget ind i monteringspladens holdere.
 20
6. Skub beslaget i monteringspladen ned indtil anslag.
 21
7. Skru beslaget fast til monteringspladen (PH1, drejningsmoment: 0,8 Nm).
 22
8. Sæt et dæksel med indhakket nedad på rosetbasen.
 23
9. Sæt dækslet på beslaget.
 24
10. Sæt det udvendige håndtag på beslaget.
 25
11. Bestem den ønskede drejeretning for dit indvendige håndtag.
12. Indsæt fjederelementet i overensstemmelse hermed.
13. Anbring underlaget i den indvendige håndtagsenhed.
 26
 27
14. For 8,5 mm og 10 mm firkant: Skub adaptertyllen ind i midten af firkanten. Lav en fordybning i adaptertyllen med en hammer og en kørner for at forhindre, at den glider.
 28
 29
15. Mål firkantens samlede længde.
 30
16. Bestem firkantens inderside (firkantens ende til midten af den første rille = 26 mm).
17. Bestem O-ringens placering med tabellen.
 31

Område	Dørtykkelse (mm)	Firkantens længde (mm)	Ringens position
S	40 - 42	94	3
S	40 - 42	104	5
S	43 - 47	94	2
S	43 - 47	104	4
S	48 - 52	94	1
S	48 - 52	104	3
S	53 - 57	104	2
S	58 - 61	104	1
M	60 - 62	114	3
M	60 - 62	124	5
M	63 - 67	114	2
M	63 - 67	124	4
M	68 - 72	114	1
M	68 - 72	124	3
M	73 - 77	124	2
M	78 - 81	124	1
L	80 - 82	134	3
L	80 - 82	144	5
L	83 - 87	134	2
L	83 - 87	144	4
L	88 - 92	134	1
L	88 - 92	144	3
L	93 - 97	144	2
L	98 - 101	144	1
XL	100 - 184	O-ringen er 30-35 mm fra den afsavede ende af firkanten.	

18. Skub O-ringen ind i den beregnede rille.
 32
19. Sæt firkanten med den ringfrie side så langt ind i døren, som den kan komme.
 33
20. For FH: Indsæt blindcylindern.

**BEMÆRK****Før blindcylindern med skruetrækker i hullet**

Især ved tykke døre er det svært at placere blindcylindern korrekt.

1. Sæt en skruetrækker ind i hullet i blindcylindern.
2. Placer blindcylindern ved hjælp af skruetrækkeren.



34



35

21. For FH: Skru blindcylindern fast (PH2, drejningsmoment: 1,1 Nm).



36

22. Skru den indvendige håndtagsenhed på firkanten (PH2, drejningsmoment: 1,1 Nm).



37

23. Skru rosetbasen fast på indersiden (PH2, drejningsmoment: 1,1 Nm).



38

24. Spænd de to håndtags gevindskruer (TX15, drejningsmoment: 5,0 Nm).



39

25. Sæt det indvendige håndtagsdæksel med hakket nedad på det indvendige håndtags roset.



40

26. Sæt et dæksel med indhakket nedad på rosetbasen.



41

- ↳ Beslaget er færdigmonteret.

10. Afmontering af beslag

- ✓ Anvend 1,5 mm unbrakonøgle.

1. Afmonter beslaget i omvendt rækkefølge i forhold til monteringen.
2. Sæt en 1,5 mm sekskantnøgle ind i hullet på den firkantede holder i beslaget.



42

3. Bøj sekskantnøglen til den side, hvor hullet er placeret, og træk samtidig i det udvendige håndtag.



43

- ↳ Beslaget er afmonteret.

11. Udskiftning af batterier



BEMÆRK

Funktionsfejl på grund af dårlig kontakt eller anden afladning

For små / forurenede kontaktområder eller forskellige afladede batterier kan føre til funktionsfejl.

1. Anvend kun batterier, som er frigivet af SimonsVoss.
2. Børør ikke de nye batteriers kontakter med hænderne.
3. Anvend rene og fedtfrie handsker.
4. Skift derfor altid alle batterier samtidigt.

- ✓ Specialværktøj er tilgængeligt.
✓ Handsker til rådighed.

1. Sæt specialværktøjet ind i dækslet på beslagsiden.



44

2. Tag dækslet af med værktøjet.



45



46

3. Bøj forsigtigt batteriklemmen indad for at hægte den af.



47



48

4. Åbn batteriklemmen.



49

5. Træk batteriklemmen ud.



50

6. Tag de gamle batterier ud.



51

7. Sæt de nye batterier i med de positive poler i berøring (type CR2450).



52

8. Sæt batteriklemmen på igen.



53

9. Sæt batteriklipsen på plads igen.



54

10. Sæt dækslet tilbage på beslaget.



55

11. Klips dækslet fast igen.



56

- ↳ Batterierne er udskiftet.

12. Tekniske data

Temperaturområde (drift)	-25 °C til +50 °C
Batteritype	4× CR2450 (3V)
Batteriproducent	<ul style="list-style-type: none"> ■ Murata ■ Varta ■ Panasonic
IP-kapslingsklasse	IP40

Radio emissions

15,24 kHz - 72,03 kHz Kun for artikelnumre: SV-S2.*A*, SV-S2.*AM*, SV-S2.*LN*	10 dBµA/m (3 m afstand)
13,560006 MHz - 13,560780 MHz	1,04 dBµA/m (3 m afstand)
868,000 MHz - 868,600 MHz / 869,700 MHz - 870,000 MHz Kun for artikelnumre: SV-S2.*LN*, SI-S2.*M.WO*	<25 mW ERP
2402 MHz - 2480 MHz	2,5 mW

13. Overensstemmelseserklæring

Hermed erklærer SimonsVoss Technologies GmbH at varen (SV-S2.*A*, SV-S2.*AM*, SV-S2.*LN*, SI-S2.*M.WO*, SI-S2.*M.VCN*) overholder følgende retningslinjer:

- 2014/53/EU -RED- eller for Storbritannien: UK lovbekendtgørelse 2017 nr. 1206 -Radioudstyr-
- 2011/65/EU -RoHS- eller for Storbritannien: UK lovbekendtgørelse 2012 nr. 3032 -RoHS-



Den fulde ordlyd af EU-overensstemmelseserklæringen er tilgængelig på følgende internetadresse: www.simons-voss.com/dk/certifikater.html. Den fulde ordlyd af UK-overensstemmelseserklæringen er tilgængelig på følgende internetadresse: www.simons-voss.com/dk/certifikater.html.

14. Hjælp og flere oplysninger

Infomateriale/dokumenter

<https://www.simons-voss.com/dk/dokumenter.html>
<https://www.smartintego.com/int/home/infocenter/documentation>

Overensstemmelseserklæringer

<https://www.simons-voss.com/dk/certifikater.html>

Oplysninger om bortskaffelse

- Enheden (SV-S2.*A*, SV-S2.*AM*, SV-S2.*LN*, SI-S2.*M.WO*, SI-S2.*M.VCN*) må ikke bortskaffes med husholdningsaffaldet, men skal afleveres på den kommunale affaldsplads, jf. det europæiske direktiv 2012/19/EU.
- Brugte eller defekte batterier skal genanvendes jf. det europæiske direktiv 2006/66/EG.
- Overhold de lokale bestemmelser for separat bortskaffelse af batterier.
- Aflever emballagen til miljørigtig genanvendelse.



57

e-mail

support-simonsvoss@allegion.com
si-support-simonsvoss@allegion.com

SimonsVoss Technologies GmbH, Feringastr. 4, D-85774 Unterföhring, Tyskland

1. Avsedd användning

Produkterna i SmartHandle AX-serien gäller elektroniska dörrhandtag. Med hjälp av ett behörigt identifikationsmedium kan man aktivera SmartHandle AX och öppna motsvarande dörr.

Behörigheter måste tilldelas med hjälp av ett elektroniskt lässchema.

Produkterna i SmartHandle AX-serien får bara användas för att öppna och stänga dörrar. Varje annan användning är förbjuden.

2. Allmänna säkerhetsanvisningar

Signalord: Eventuella omedelbara effekter av bristande efterlevnad

WARNING: Död eller allvarlig skada (möjligt, men osannolikt), **OBSERVERA:** Liten skada, **OBS:** Skador på egendom eller fel, **INFO:** Låg eller ingen



WARNING

Tillgång spärrad

Felaktigt installerade och/eller programmerade komponenter kan leda till att dörrar spärras. SimonsVoss Technologies GmbH ansvarar inte för konsekvenserna av felaktig installation såsom spärrat tillträde till skadade personer eller personer i risksituationer, materiella skador eller andra typer av skador.

Blockerad åtkomst genom manipulering av produkten

Om du ändrar produkten på egen hand kan fel uppstå och åtkomst via en dörr kan blockeras.

- Ändra endast produkten vid behov och endast på det sätt som beskrivs i dokumentationen.

Swälj inte batteriet. Risk för brännskador på grund av farliga ämnen.

Den här produkten innehåller litiumknappcells-batterier. Om man råkar svälja ett knappcells-batteri kan allvariga inre brännskador uppstå inom bara två timmar vilket i sin tur kan leda till döden.

- Förvara nya och förbrukade batterier utom räckhåll för barn.
- Upphör att använda produkten och förvara den utom räckhåll för barn om batterilocket inte går att stänga ordentligt.
- Uppök omedelbart läkare om du misstänker att batterier har svälts eller befinner sig i någon kroppsdel.

Explosionsrisk på grund av felaktig batterityp

Att sätta i fel typ av batteri kan leda till en explosion.

- Använd endast de batterier som anges i de tekniska data.



OBSERVERA

Brandrisk som utgår från batterier

De isatta batterierna kan orsaka brand eller brännskador om de hanteras på ett felaktigt sätt.

- Försök inte att ladda upp, öppna eller värma upp batterierna.
- Kortslut inte batterierna.

OBS

Skador på grund av elektrostatisk urladdning (ESD) när höljiet är öppet

Den här produkten innehåller elektroniska komponenter som kan skadas av elektrostatiska urladdningar.

- Använd alltid ESD-anpassat arbetsmaterial (t.ex. jordningsarmband).
- Jorda dig före alla arbeten där du kan komma i kontakt med elektronik. Det gör du genom att fatta tag i en jordad metallyta (såsom dörkarmar, vattenrör eller värmeventiler).

Skada på grund av våtskor

Den här produkten innehåller elektroniska och/eller mekaniska komponenter som kan skadas av alla typer av våtskor.

- Låt inte elektroniken komma i kontakt med våtskor.

Skada på grund av aggressiva rengöringsmedel

Ytan på den här produkten kan skadas om olämpliga rengöringsmedel används.

- Använd endast rengöringsmedel som lämpar sig för plast- och metalltytor.

Skada på grund av mekanisk påverkan

Den här produkten innehåller elektroniska komponenter som kan skadas av alla typer av mekanisk påverkan.

- Undvik att vidröra elektroniken.
- Undvik annan mekanisk påverkan på elektroniken.

Skada på grund av polvändning

Den här produkten innehåller elektroniska komponenter som kan skadas på grund av polvändning i spänningskällan.

- Vänd inte spänningskällans poler (batterier resp. nätdelar).

Driftstörning på grund av radiostörning

Den här produkten kan i vissa fall påverkas av elektromagnetiska eller magnetiska störningar.

- Produkten ska inte monteras eller placeras i omedelbar närhet av utrustning som kan orsaka elektromagnetiska eller magnetiska störningar (switchade nätaggregat!).

Kommunikationsstörning på grund av metallytor

Den här produkten kommunicerar trådlöst. Metallytor kan minska produktens räckvidd avsevärt.

- Produkten ska inte monteras eller placeras på eller i närheten av metallytor.



INFO

Avsedd användning

SimonsVoss-produkter är uteslutande avsedda för öppning och stängning av dörrar och liknande.

- Använd inte SimonsVoss-produkter för andra syften.

Funktionsstörningar på grund av dålig dålig kontakt eller annan urladdning

För små / kontaminerade kontaktytor eller olika urladdade batterier kan leda till funktionsstörningar.

- Används endast batterier som är godkända av SimonsVoss.
- Vidrör inte de nya batteriernas kontakter med händerna.
- Använd rena och fettfria handskar.
- Byt alltid alla batterier samtidigt.

Avvikande tider vid G2-lås

G2-låsens interna tidsenhet har en tekniskt betingad tolerans på upp till ± 15 minuter per år.

Kvalifikationer krävs

Installation och idrifttagning kräver specialiserad kunskap.

- Endast utbildad personal får installera och driftsätta produkten.

Ändringar eller teknisk vidareutveckling kan inte uteslutas och kan komma att genomföras utan föregående meddelande om detta.

Den tyska språkversionen är den ursprungliga bruksanvisningen. Andra språk (utarbetade på kontraktsspråket) är översättningar av originalinstruktionerna.

Läs och följ alla installations-, installations- och driftsinstruktioner. Skicka dessa instruktioner och alla underhållsinstruktioner till användaren.

3. Produktspecifika säkerhetsanvisningar

OBS

Skada vid borring

De borrar på egen risk. För skador orsakade av borring är SimonsVoss Technologies GmbH inte ansvarigt. Sie bohren auf eigene Gefahr.

- Beakta också borrhens säkerhetsinstruktioner.

Skador på grund av olämpligt verktyg

Att försöka öppna ärendet med ett felaktigt verktyg kan skada fallet.

- Använd endast det medföljande SimonsVoss-öppningsverktyget.

Förlust av exakt handtagsstyrning

Hos instickslåås med klämhylsa kan monteringen vara trög.

- Bearbeta inte klämhylsan mekaniskt. Handtaget förlorar då sin exakta styrning.

Försvårad montering på grund av oprecisa hål

Handtaget kan inte monteras om monteringshålen och fyrkanten inte passar ihop.

- Säkerställ att fästhålen och fyrkanten står i vertikal linje.

**INFO****Påverkan på låsningen**

SmartHandle AX fungerar uteslutande på spärrlåset.

Försäkringslagstiftning

Försäkringsbolag ställer större krav på stängning.

- Om du vill stänga dörren enligt försäkringslagarna, använd ett självlåsande paniklås eller en låscylinder utöver SmartHandle AX.
- Var uppmärksam på godkännandena enligt EN 179.

SmartHandle AX med självlåsande paniklås

SmartHandle AX erbjuder full funktionalitet endast med ett självlåsande paniklås.

- Kombinera SmartHandle AX med ett självlåsande paniklås.
- Var uppmärksam på förklaringarna om överensstämmelse hos låsetillverkaren enligt EN 179.

Villkor för säkerhet i samband med tillstånd

Drift med Mifare Classic- och/eller PinCode-tangentbord utesluter behörighetssäkerhetsklass D enligt DIN EN 16867:2020.

Försluta rosettöppning

En rosettöppning kan utnyttjas för manipulation.

- Roslet eventuella rosettöppningar med exempelvis en blindcylinder.
- För FH-varianter: Montera ovlirkortigen en blind- eller låscylinder av mässing.

4. Leveransomfång

- SmartHandle AX (Rörramsvariant)

- Specialverktyg

- Snabbguide

För FH-variant:

- Blindcylinder

5. Uppbyggnad**6. Förbereda dörr (borrschablon)**

- ✓ PH2-skruvmejsel finns.
- ✓ Stift eller ritsnål finns.
- ✓ Borrmaskin finns.
- ✓ Lämpligt borrstål (Ø 7,2 mm).
- ✓ Konförsänkare finns.

- Stick in fyrkanten i instickslåset.



- Sätt på borrschablonen på fyrkanten.



- Rikta in borrschablonen lodrätt med hjälp av den påtryckta skalan.

- Markera borrhålen på dörren.



- Avlägsna borrhålschablonen.



- Avlägsna fyrkanten.



- Demontera instickslåset (PH2).



- Borra de hål som behövs.



- Försänk hålen med konförsänkaren så mycket att blindnitmuttrarna senare kan pressas in utan att sticka ut.



- Montera instickslåset (PH2).

**7. För dörrtjocklek X: Förbereda fyrkant**

- ✓ Såg finns.
- ✓ Skjutmått finns.
- ✓ PH2-skruvmejsel finns.

- För X: Mät dörrtjockleken.
- För X: Markera sågstatlet på fyrkanten.

**INFO****9 mm-fyrkant med 8 mm-ände**

9 mm-fyrkanten har en 8 mm-ände. Den här änden sticks in i det elektroniska handtaget.

- Korta 9 mm-fyrkanten så att 8 mm-änden inte befinner sig den bortsgade delen.



- För X: Korta av fyrkanten med en lämplig såg.

**8. Programmera handtag**

Programmera handtaget före montering. Beroende på produktfamilj kan du använda olika programmeringsenheter.

**9. Montera handtag**

- ✓ Dörr förborrad.
- ✓ PH2-skruvmejsel finns.
- ✓ TX15-skruvmejsel finns.

- Sätt in de medföljande blindnitmuttrarna i dörrkarmen.



- Skruva fast monteringsplattan på utsidan på så sätt att fjäderklämmorna pekar mot dörren (PH2, åtdragningsmoment: 1,1 Nm).













- Skruva fast rosettbasen med på utsidan (PH2, åtdragningsmoment: 1,1 Nm).





- Skruva fast rosettbasen med på insidan (PH2, åtdragningsmoment: 1,1 Nm).

- Sätt in handtaget i monteringsplattans fästen.



6. Skjut in beslaget nedåt i monteringsplattan till anslaget.
 21
7. Skruva fast beslaget på monteringsplattan (PH1, åtdragningsmoment: 0,8 Nm).
 22
8. Sätt fast ett skydd på rosettbasen med ursparningen vänd nedåt.
 23
9. Sätt kåpan på modulen.
 24
10. Sätt ytterhandtaget på beslaget.
 25
11. Fastställ önskad vridriktning för innerhandtaget.
12. Sätt i fjäderelementet enligt motsvarande.
13. Sätt in underlägget i innerhandtagsenheten.
 26
 27
14. För 8,5 mm- och 10 mm-fyrkant: Skjut in adapterhylsan i mitten av fyrkanten. Gör en fördjupning i adapterhylsan med en körnare och hammare för att förhindra att den glider.
 28
 29
15. Mät fyrkantens totallängd.
 30
16. Fastställ fyrkantens insida (fyrkantsände till mitten av första spår = 26 mm).
17. Bestäm O-ringens position med tabellen.
 31

Område	Dörrtjocklek (mm)	Fyrkantslängd (mm)	Ringposition
S	40–42	94	3
S	40–42	104	5
S	43–47	94	2
S	43–47	104	4
S	48–52	94	1
S	48–52	104	3
S	53–57	104	2
S	58–61	104	1
M	60–62	114	3
M	60–62	124	5
M	63–67	114	2
M	63–67	124	4
M	68–72	114	1
M	68–72	124	3
M	73–77	124	2
M	78–81	124	1
L	80–82	134	3
L	80–82	144	5
L	83–87	134	2
L	83–87	144	4
L	88–92	134	1
L	88–92	144	3
L	93–97	144	2
L	98–101	144	1
XL	100–184	O-ringens ligger 30–35 mm från fyrkantens avsågade ände.	

18. Skjut på O-ringens på det beräknade spåret.
 32
19. Skjut in fyrkanten med den ringfria sidan till anslag i dörren.
 33
20. För FH: Sätt i blindcylindern.



INFO

För in blindcylindern i hålet med skruvmejseln.

Särskilt om dörrarna är tjocka är det svårt att positionera blindcylindern korrekt.

1. Sätt in en skruvmejseln i hålet för blindcylindern.
2. Positionera blindcylindern med hjälp av skruvmejseln.



34



35

21. För FH: Skruva fast blindcylindern (PH2, åtdragningsmoment: 1,1 Nm).



36

22. Skruva på innerhandtagsenheten på fyrkanten (PH2, åtdragningsmoment: 1,1 Nm).



37

23. Skruva fast rosettbasen med på insidan (PH2, åtdragningsmoment: 1,1 Nm).



38

24. Skruva fast de båda handtagens stoppskruvar (TX15, åtdragningsmoment: 5,0 Nm).



39

25. Sätt fast ett innerhandtagsskydd på rosettbasen med ursparningen vänd nedåt.



40

26. Sätt fast ett skydd på rosettbasen med ursparningen vänd nedåt.



41

- ↳ Handtaget är färdigmonterat.

10. Demontera handtag

- ✓ 1,5 mm sexkantsnyckel finns.

1. Demontera handtaget i omvänd ordningsföljd jämfört med montering.
2. Sätt i en 1,5 mm-insexnyckel i hålet på fyrkantsfästet i handtaget.



42

3. Böj insexnyckeln åt den sida där hålet sitter och dra samtidigt i ytterhandtaget.



43

- ↳ Handtaget är demonterat.

11. Byt batterier.



INFO

Funktionsstörningar på grund av dålig dålig kontakt eller annan urladdning

För små / kontaminerade kontaktytor eller olika urladdade batterier kan leda till funktionsstörningar.

- Används endast batterier som är godkända av SimonsVoss.
- Vidrör inte de nya batteriernas kontakter med händerna.
- Använd rena och fettfria handskar.
- Byt alltid alla batterier samtidigt.

- ✓ Specialverktyg finns.
✓ Handskar finns.

1. Sätt i specialverktyget i kåpinlägget på handtaget.



44

2. Avlägsna kåpan med verktyget.



45



46

3. Böj batteriklämman försiktigt inåt för att haka ur den.



47



48

4. Öppna batteriklämman.



49

5. Dra ut batteriklämman.



50

6. Ta ur de gamla batterierna.



51

7. Sätt i de nya batterierna så att pluspolerna vidrör varandra (typ CR2450).



52

8. Sätt tillbaka batteriklämman igen.



53

9. Haka i batteriklämmorna igen.



54

10. Sätt tillbaka kåpan på handtaget.



55

11. Knäpp fast kåpan igen.



56

- ↳ Batterierna är bytta.

12. Tekniska data

Temperaturområde (drift)	-25 °C till +50 °C
Batterityp	4 × CR2450 (3V)
Batteritillverkare	<ul style="list-style-type: none"> ■ Murata ■ Varta ■ Panasonic
IP-kapslingsklass	IP40

Utsläpp radio

15,24 kHz - 72,03 kHz Endast för artikelnummer: SV-S2.*A*, SV-S2.*AM*, SV-S2.*LN*	10 dBµA/m (3 m avstånd)
13,560006 MHz - 13,560780 MHz	1,04 dBµA/m (3 m avstånd)
868,000 MHz - 868,600 MHz / 869,700 MHz - 870,000 MHz Endast för artikelnummer: SV-S2.*LN*, SI-S2.*M.WO*	<25 mW ERP
2402 MHz - 2480 MHz	2,5 mW

13. Försäkran om överensstämmelse

Häri förklarar SimonsVoss Technologies GmbH att varan (SV-S2.*A*, SV-S2.*AM*, SV-S2.*LN*, SI-S2.*M.WO*, SI-S2.*M.VCN*) uppfyller följande riktlinjer:

- 2014/53/EU - RED- eller för Storbritannien: Förenade kungarikets lag 2017 nr 1206 - Radioutrustning-
- 2011/65/EU - RoHS- eller för Storbritannien: Förenade kungarikets lag 2012 nr 3032 - RoHS-



Den fullständiga texten till EU-försäkran om överensstämmelse finns på följande internetadress: www.simons-voss.com/se/certifikat.html.
Den fullständiga texten till UK-försäkran om överensstämmelse finns på följande internetadress: www.simons-voss.com/se/certifikat.html.

14. Hjälps och ytterligare information

Infomaterial/dokument

<https://www.simons-voss.com/se/dokument.html>

<https://www.smartintego.com/int/home/infocenter/documentation>

Försäkningar om överensstämmelse

<https://www.simons-voss.com/se/certifikat.html>

Informationen är öppen

- Produkten (SV-S2.*A*, SV-S2.*AM*, SV-S2.*LN*, SI-S2.*M.WO*, SI-S2.*M.VCN*) får inte slängas i hushållsoporna utan ska lämnas in på en kommunal uppsamlingsplats för elektriskt och elektroniskt avfall i enlighet med direktiv 2012/19/EU.
- Defekta eller uttjänta batterier ska återvinnas i enlighet med direktiv 2006/66/EG.
- Beakta gällande lokala bestämmelser gällande separat bortskaftande av batterier.
- Avfallshantera förpackningsmaterial på ett miljövänligt sätt.



57

support-simonsvoss@allegion.com

si-support-simonsvoss@allegion.com

SimonsVoss Technologies GmbH, Feringastr. 4, D-85774 Unterföhring, Tyskland

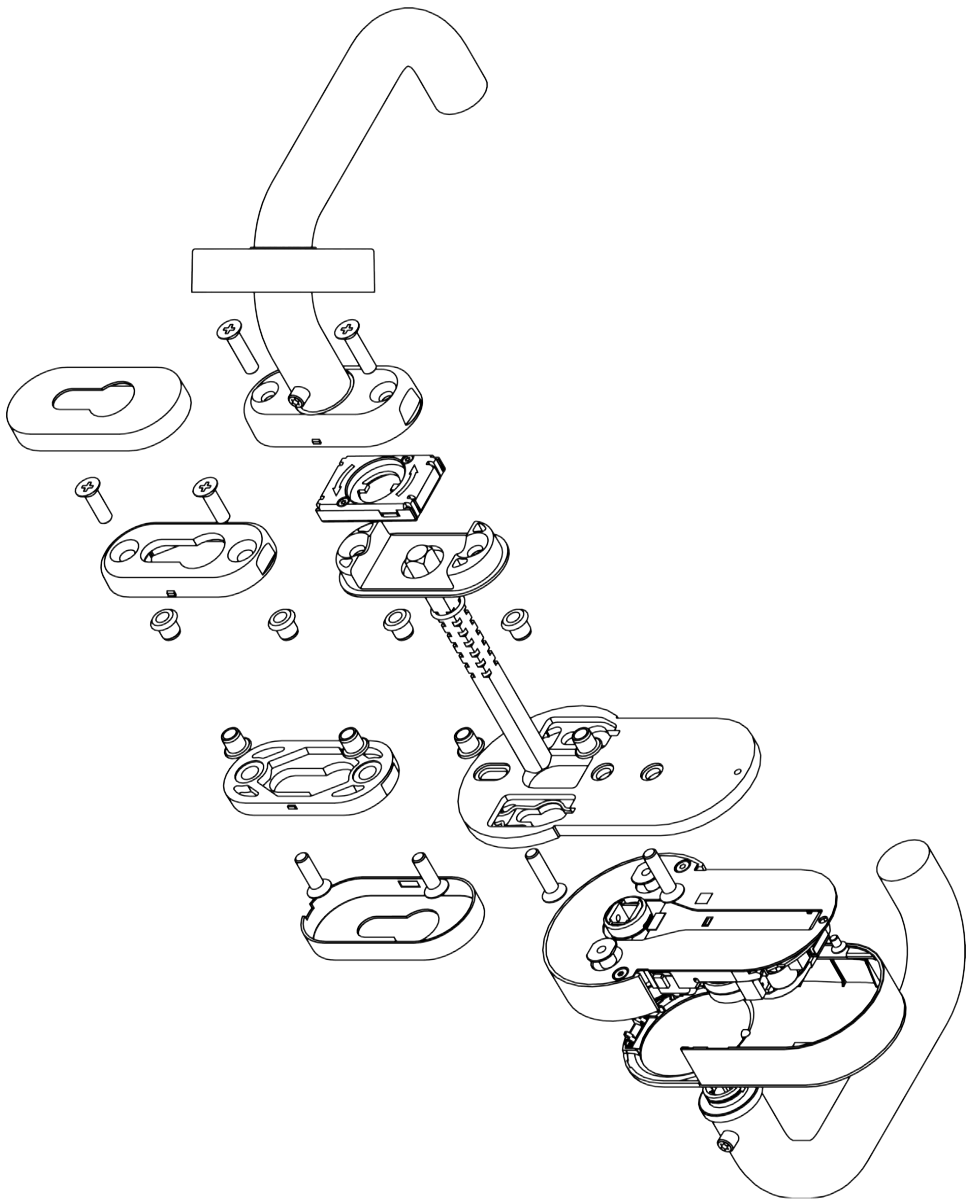

© 2024, SimonsVoss Technologies GmbH, Unterföhring

All rights are reserved. Text, images and diagrams are protected under copyright law.

The content of this document must not be copied, distributed or modified. You can find more information on our website. Subject to technical changes.

SimonsVoss and MobileKey are registered brands belonging to SimonsVoss.

SimonsVoss
technologies

Made in Germany

A BRAND OF

