



DE	Kurzanleitung
EN	Quick Guide
FR	Guide abrégé
NL	Korte handleiding
IT	Guida breve
DK	Kort vejledning
SE	Snabbguide

Digital Cylinder AX (Z5) Escape thumb-t.

Z550.99050008
06.03.2024

Simons  **Voss**
technologies

Abbildungen/Images	3
deutsch	29
english	43
français	56
nederlands	69
italiano	82
dansk	95
svensk.....	107

3. Installation situations



DIN L
outwards opening

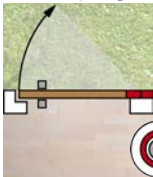

DIN R
inward opening





DIN L
inward opening

DIN R
outwards opening

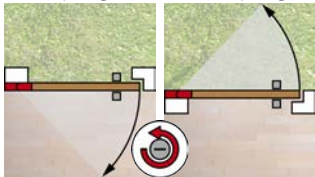

4. Installation on fitted cylinder (clockwise un-
locking)

SW1.5



3

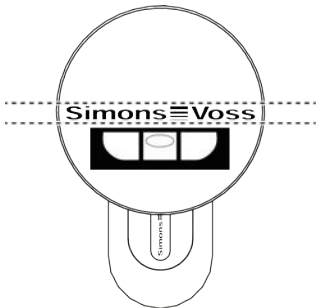

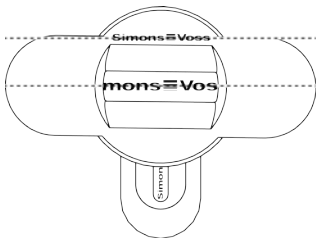



SW1.5

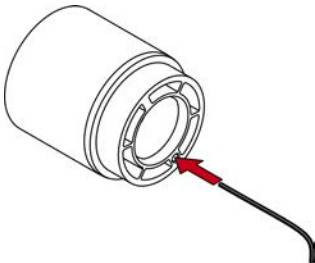

4. Installation on fitted cylinder (clockwise un-
locking)

8 / 120 | EN

 6



SW1.5

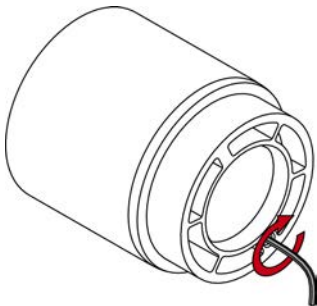

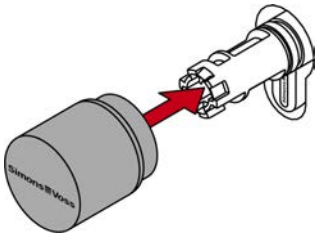

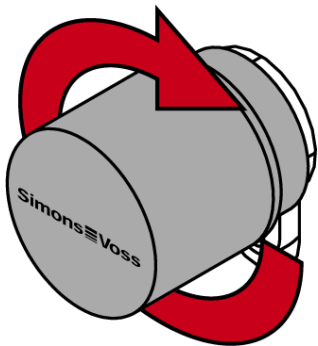

5. Installation on the removed cylinder (anti-clockwise unlocking)



SW1.5



3

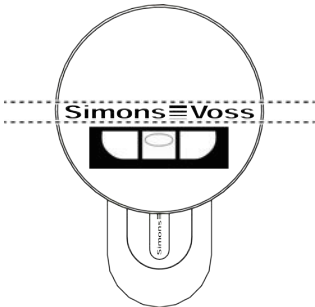

5. Installation on the removed cylinder (anti-clockwise unlocking)

12 / 120 | EN

 4

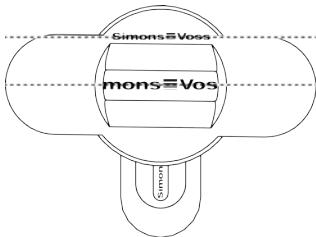

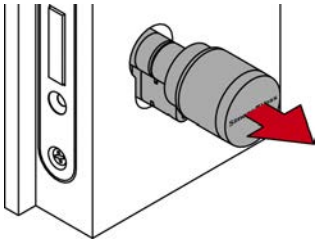

5. Installation on the removed cylinder (anti-clockwise unlocking)

14 / 120 | EN

 5



SW1.5

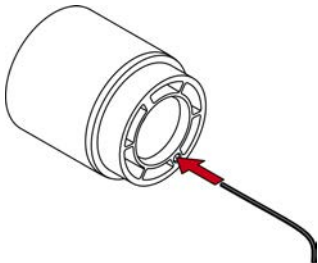

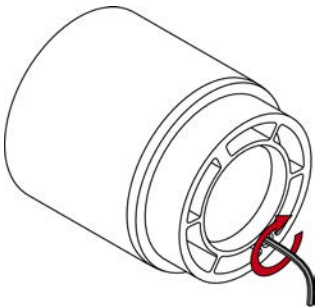

 14

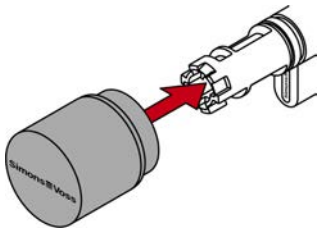

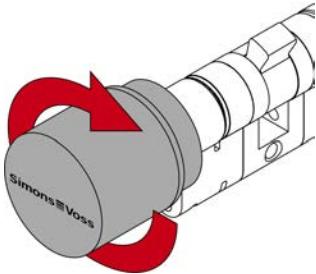

5. Installation on the removed cylinder (anti-clockwise unlocking)

18 / 120 | EN

 16



SW1.5

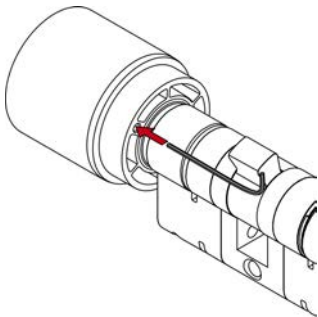



SW1.5

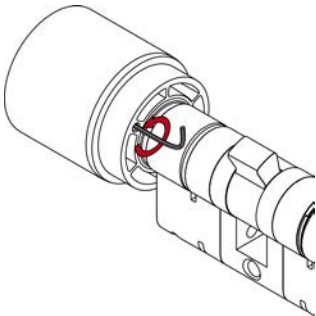

5. Installation on the removed cylinder (anti-clockwise unlocking)

20 / 120 | EN

 18

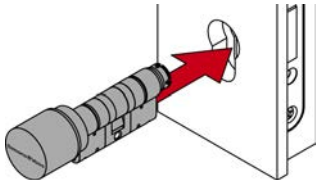

 19

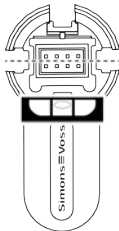

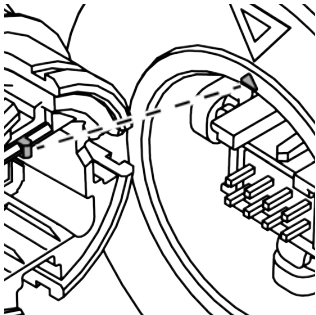
 20

 21

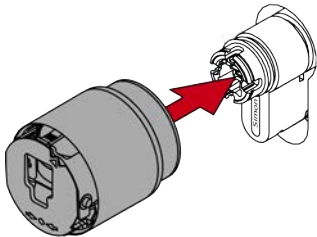



SW1.5

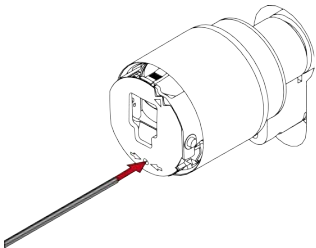

5. Installation on the removed cylinder (anti-clockwise unlocking)

24 / 120 | EN

 23



SW1.5

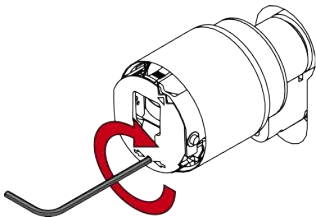



SW1.5

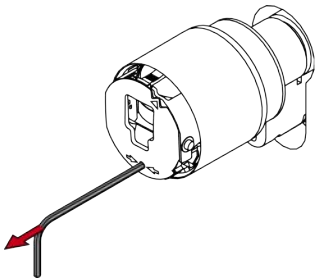

 25

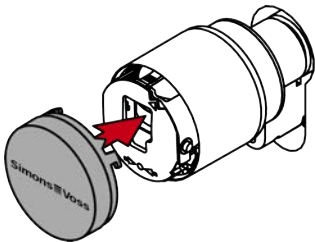

 26



Inhaltsverzeichnis

1. Allgemeine Sicherheitshinweise..... 30
2. Bestimmungsgemäßer Gebrauch 32
3. Einbausituationen 33
4. Montage am eingebauten Zylinder (Entriegeln im Uhrzeigersinn)..... 34
5. Montage am ausgebauten Zylinder (Entriegeln gegen den Uhrzeigersinn) 36
6. Hilfe und weitere Informationen..... 41

1. Allgemeine Sicherheitshinweise

Signalwort: Mögliche unmittelbare Auswirkungen bei Nichtbeachtung

WARNUNG: Tod oder schwere Verletzung (möglich, aber unwahrscheinlich)
ACHTUNG: Sachschäden oder Fehlfunktionen, **HINWEIS:** Geringe oder keine



WARNUNG

Versperrter Zugang

Durch fehlerhaft montierte und/oder programmierte Komponenten kann der Zutritt durch eine Tür versperrt bleiben. Für Folgen eines versperrten Zutritts wie Zugang zu verletzten oder gefährdeten Personen, Sachschäden oder anderen Schäden haftet die SimonsVoss Technologies GmbH nicht!

Versperrter Zugang durch Manipulation des Produkts

Wenn Sie das Produkt eigenmächtig verändern, dann können Fehlfunktionen auftreten und der Zugang durch eine Tür versperrt werden.

- ❖ **Verändern Sie das Produkt nur bei Bedarf und nur in der**

Dokumentation beschriebenen Art und Weise.

ACHTUNG

Beschädigung durch Öle, Fette, Farben und Säuren

Dieses Produkt enthält elektronische und/oder mechanische Bauteile, die durch Flüssigkeiten aller Art beschädigt werden können.

- ❖ Halten Sie Öle, Fette, Farben und Säuren vom Produkt fern.

Beschädigung durch aggressive Reinigungsmittel

Die Oberfläche dieses Produkts kann durch ungeeignete Reinigungsmittel beschädigt werden.

- ❖ Verwenden Sie ausschließlich Reinigungsmittel, die für Kunststoff- bzw. Metalloberflächen geeignet sind.



HINWEIS

Bestimmungsgemäßer Gebrauch

SimonsVoss-Produkte sind ausschließlich für das Öffnen

und Schließen von Türen und vergleichbaren Gegenständen bestimmt.

- ❖ Verwenden Sie SimonsVoss-Produkte nicht für andere Zwecke.

Qualifikationen erforderlich

Die Installation und Inbetriebnahme setzt Fachkenntnisse voraus.

- ❖ Nur geschultes Fachpersonal darf das Produkt installieren und in Betrieb nehmen.

Änderungen bzw. technische Weiterentwicklungen können nicht ausgeschlossen und ohne Ankündigung umgesetzt werden.

Die deutsche Sprachfassung ist die Originalbetriebsanleitung. Andere Sprachen (Abfassung in der Vertragssprache) sind Übersetzungen der Originalbetriebsanleitung.

Lesen Sie alle Anweisungen zur Installation, zum Einbau und zur Inbetriebnahme und befolgen Sie diese. Geben Sie diese Anweisungen und jegliche Anweisungen zur Wartung an den Benutzer weiter.

2. Bestimmungsgemäßer Gebrauch

Der Escape-Knauf für den Digital Cylinder AX ist mit einer

Ratschenfunktion ausgestattet. Er ersetzt den Innenknauf eines Comfortzylinders.

- ❖ Entriegeln von innen jederzeit ohne Identmedium möglich
- ❖ Verriegeln nur von außen und nur mit Identmedium möglich.

Der Escape-Knauf eignet sich sowohl für DIN-L- als auch für DIN-R-Türen. Stellen Sie die Drehrichtung einfach im ausgebauten Zustand ein.

Personen können jederzeit aus Räumen flüchten, die mit Comfortzylindern und Escape-Knäufen ausgestattet sind.

3. Einbausituationen

Je nach Einbausituation unterscheidet sich die Montage:

Entriegeln im Uhrzeigersinn



1

Der Escape-Knauf entriegelt die Tür im Uhrzeigersinn. Der Zylinder muss nicht ausgebaut werden (siehe *Montage am eingebauten Zylinder (Entriegeln im Uhrzeigersinn)* [▶ 34]).

Entriegeln gegen den Uhrzeigersinn



2

Der Escape-Knauf entriegelt die Tür gegen den Uhrzeigersinn. Bauen Sie während der Montage den Zylinder

aus (siehe *Montage am ausgebauten Zylinder (Entriegeln gegen den Uhrzeigersinn)* [[▶ 36](#)]).

4. Montage am eingebauten Zylinder (Entriegeln im Uhrzeigersinn)

Mechanischen Knauf demontieren

✓ Spezialwerkzeug vorhanden.

1. Richten Sie den Knauf waagrecht aus.



3

2. Setzen Sie das Spezialwerkzeug an.

3. Richten Sie das Spezialwerkzeug so aus, dass das Logo parallel zur Aussparung ist.



4

4. Drehen Sie das Spezialwerkzeug und den Knauf gleichzeitig gegen den Uhrzeigersinn.

5. Ziehen Sie das Spezialwerkzeug und den Knauf gleichzeitig ab.

↳ Mechanischer Knauf ist demontiert.

Escape-Knauf montieren

✓ 1,5-mm-Sechskantschlüssel vorhanden.

1. Stecken Sie den 1,5-mm-Sechskantschlüssel in den Es-

cape-Knauf.



2. Drehen Sie den Sechskantschlüssel bis zum Anschlag im Uhrzeigersinn.

↳ Escape-Knauf klickt.



3. Ziehen Sie den Sechskantschlüssel wieder heraus.
4. Stecken Sie den Escape-Knauf auf den Zylinderschaft.



5. Drehen Sie den Escape-Knauf im Uhrzeigersinn, bis er einrastet.



Funktionstest

1. Drehen und ziehen Sie am Escape-Knauf, um festzustellen, ob er ordnungsgemäß eingerastet ist.
2. Prüfen Sie, ob Sie mit dem Escape-Knauf die Tür entriegeln können.

↳ Escape-Knauf ist montiert.

5. Montage am ausgebauten Zylinder (Energie- gegen den Uhrzeigersinn)

Mechanischen Knauf demontieren

✓ Spezialwerkzeug vorhanden.

1. Richten Sie den Knauf waagrecht aus.



2. Setzen Sie das Spezialwerkzeug an.

3. Richten Sie das Spezialwerkzeug so aus, dass das Logo parallel zur Aussparung ist.



4. Drehen Sie das Spezialwerkzeug und den Knauf gleichzeitig gegen den Uhrzeigersinn.

5. Ziehen Sie das Spezialwerkzeug und den Knauf gleichzeitig ab.

↳ Mechanischer Knauf ist demontiert.

Zylinder ausbauen

1. Schrauben Sie die Stulpschraube heraus.

2. Bauen Sie den Zylinder aus.



Elektronischen Knauf demontieren

✓ Spezialwerkzeug vorhanden.

- ✓ 1,5-mm-Sechskantschlüssel vorhanden.
- 1. Richten Sie den Knauf waagrecht aus.
- 2. Setzen Sie das Spezialwerkzeug an.
- 3. Richten Sie das Spezialwerkzeug so aus, dass das Logo parallel zur Aussparung ist.
- 4. Halten Sie Spezialwerkzeug und Knaufkappe gleichzeitig fest und drehen Sie beides zusammen zuerst 1-2° im Uhrzeigersinn und danach gegen den Uhrzeigersinn weg.



HINWEIS

Abrutschen beim Drehen

Die Oberfläche der Knaufkappe kann rutschig sein und die Kappe sich (insbesondere bei WP-Ausführungen, erkennbar am blauen Zylinderhalsring oder der gelaserten Markierung auf der inneren Seite des Zylinderprofils) schwer drehen lassen.

- Tragen Sie rutschfeste Handschuhe.

-
- 5. Ziehen Sie das Werkzeug und die Kappe ab.
 - 6. Stecken Sie den Sechskantschlüssel bis zum Anschlag in das dafür vorgesehene Loch.

7. Drehen Sie den Sechskantschlüssel um 270 Grad gegen den Uhrzeigersinn.
8. Ziehen Sie den Sechskantschlüssel wieder heraus.
9. Ziehen Sie den Knauf ab.

↳ Elektronischer Knauf ist demontiert.

Escape-Knauf montieren

✓ 1,5-mm-Sechskantschlüssel vorhanden.

1. Stecken Sie den 1,5-mm-Sechskantschlüssel in den Escape-Knauf.



5

2. Drehen Sie den Sechskantschlüssel bis zum Anschlag im Uhrzeigersinn.

↳ Escape-Knauf klickt.



6

3. Ziehen Sie den Sechskantschlüssel wieder heraus.
4. Stecken Sie den Escape-Knauf auf den Zylinderschaft.



14

5. Halten Sie den Schließbart fest und drehen Sie den Escape-Knauf bis zum Anschlag im Uhrzeigersinn.



15

6. Stecken Sie den 1,5-mm-Sechskantschlüssel in den Es-

cape-Knauf.



7. Drehen Sie den 1,5-mm-Sechskantschlüssel bis zum Anschlag gegen den Uhrzeigersinn.

↳ Escape-Knauf klickt.



8. Bauen Sie den Zylinder wieder ein.



9. Schrauben Sie die Stulpschraube fest.

Elektronischen Knauf wieder montieren

- ✓ 1,5-mm-Sechskantschlüssel vorhanden.

1. Richten Sie die Knaufaufnahme waagrecht aus.



2. Stecken Sie den Knauf auf.





21



HINWEIS

Mitgelieferten Sechskantschlüssel verwenden

Im Lieferumfang des Spezialwerkzeugs befindet sich auch ein Sechskantschlüssel.

- Verwenden Sie diesen Sechskantschlüssel, um den elektronischen Knauf zu montieren und zu demontieren.

3. Stecken Sie den Sechskantschlüssel bis zum Anschlag in das dafür vorgesehene Loch.



22

4. Drehen Sie den Sechskantschlüssel um 270 Grad im Uhrzeigersinn.



23

5. Ziehen Sie den Sechskantschlüssel wieder heraus.



24

6. Stecken Sie die Kappe auf.



25



26

7. Drehen Sie die Kappe im Uhrzeigersinn.



- ↳ Kappe rastet mit einem Klicken ein.

- ↳ Elektronischer Knauf ist montiert.

Funktionstest

1. Drehen und ziehen Sie am Escape-Knauf, um festzustellen, ob er ordnungsgemäß eingerastet ist.
 2. Prüfen Sie, ob Sie mit dem Escape-Knauf die Tür entriegeln können.
- ↳ Escape-Knauf ist montiert.

6. Hilfe und weitere Informationen

Infomaterial/Dokumente

<https://www.simons-voss.com/de/dokumente.html>

<https://www.smartintego.com/de/home/infocenter/dokumentation>

Technischer Support

+49 (0) 89 / 99 228 333

E-Mail

support-simonsvoss@allegion.com

si-support-simonsvoss@allegion.com

FAQ

<https://faq.simons-voss.com/otrs/public.pl>

SimonsVoss Technologies GmbH, Feringastr. 4, D-85774
Unterfoehring, Deutschland

Contents

1. General safety instructions 44
2. Intended use..... 46
3. Installation situations 47
4. Installation on fitted cylinder (clockwise unlocking)
..... 48
5. Installation on the removed cylinder (anticlockwise
unlocking) 49
6. Help and other information 54

1. General safety instructions

Signal word: Possible immediate effects of non-compliance

WARNING: Death or serious injury (possible, but unlikely)IM-

PORTANT: Property damage or malfunction, NOTE: Low or

none



WARNING

Blocked access

Access through a door may stay blocked due to incorrectly fitted and/or incorrectly programmed components.

SimonsVoss Technologies GmbH is not liable for the consequences of blocked access such as access to injured or endangered persons, material damage or other damage!

Blocked access through manipulation of the product

If you change the product on your own, malfunctions can occur and access through a door can be blocked.

- ❖ Modify the product only when needed and only in the

manner described in the documentation.

IMPORTANT

Damage resulting from liquids

This product contains electronic and/or mechanic components that may be damaged by liquids of any kind.

- ❖ Keep liquids away from the electronics.

Damage resulting from aggressive cleaning agents

The surface of this product may be damaged as a result of the use of unsuitable cleaning agents.

- ❖ Only use cleaning agents that are suitable for plastic or metal surfaces.



NOTE

Intended use

SimonsVoss-products are designed exclusively for opening and closing doors and similar objects.

- ❖ Do not use SimonsVoss products for any other purposes.

Qualifications required

The installation and commissioning requires specialized knowledge.

- ❖ Only trained personnel may install and commission the product.

Modifications or further technical developments cannot be excluded and may be implemented without notice.

The German language version is the original instruction manual. Other languages (drafting in the contract language) are translations of the original instructions.

Read and follow all installation, installation, and commissioning instructions. Pass these instructions and any maintenance instructions to the user.

2. Intended use

The escape thumb-turn for the Digital Cylinder AX is equipped with a ratchet function. It replaces the inside thumb-turn of a comfort cylinder.

- ❖ Unlocking from inside possible at any time without an identification medium
- ❖ Locking only possible from the outside and only with an identification medium.

The escape thumb-turn is suitable for DIN L and DIN R doors. Simply adjust the direction of rotation when it is removed.

People can escape rooms fitted with comfort cylinders and escape thumb-turns at any time.

3. Installation situations

Installation differs depending on the installation situation:

Unlocking clockwise



1

The escape thumb-turn unlocks the door in a clockwise direction. The cylinder does not need to be removed (see *Installation on fitted cylinder (clockwise unlocking)* [▶ 48]).

Unlocking anti-clockwise



2

The escape thumb-turn unlocks the door in an anti-clockwise direction. Remove the cylinder during installation (see *Installation on the removed cylinder (anticlockwise unlocking)* [▶ 49]).

4. Installation on fitted cylinder (clockwise un- locking)

Removing the mechanical thumb-turn

✓ Special tool available.

1. Align the thumb turn horizontally.



2. Attach the special tool.

3. Align the special tool so that the logo is parallel to the recess.



4. At the same time turn the special tool and the thumb turn counterclockwise.

5. Remove the special tool and the thumb turn at the same time.

↳ The mechanical thumb turn is disassembled.

Installing the escape thumb-turn

✓ 1.5 mm hexagonal wrench available.

1. Insert the 1.5 mm hex key into the escape thumb turn.



2. Turn the hex key fully clockwise until it comes to a stop.

↳ Escape thumb turn clicks.



6

3. Pull out the hexagon wrench again.
4. Place the escape thumb turn on the cylindrical shaft.



7

5. Turn the escape thumb-turn clockwise until it engages.



8

Functional test

1. Turn and pull the escape thumb-turn to check that it is properly locked in position.
2. Check that you can unlock the door with the escape thumb-turn.

↳ Escape thumb turn is installed.

5. Installation on the removed cylinder (anti-clockwise unlocking)

Removing the mechanical thumb-turn

✓ Special tool available.

1. Align the thumb turn horizontally.



3

2. Attach the special tool.
3. Align the special tool so that the logo is parallel to the

recess.



4. At the same time turn the special tool and the thumb turn counterclockwise.
5. Remove the special tool and the thumb turn at the same time.

↳ The mechanical thumb turn is disassembled.

Removing the cylinder

1. Unscrew the fastening screw.
2. Remove the cylinder.



Disassembling the electronic thumb-turn

- ✓ Special tool available.
 - ✓ 1.5 mm hexagonal wrench available.
1. Align the thumb turn horizontally.
 2. Attach the special tool.
 3. Align the special tool so that the logo is parallel to the recess.
 4. Hold the special tool and thumb turn cap firmly at the same time and turn them together 1-2° clockwise first

and then counter-clockwise.



NOTE

Slipping when turning







The surface of the thumb turn cap can be slippery and the cap can be difficult to turn (especially with WP versions, recognizable by the blue cylinder neck ring or the lasered marking on the inner side of the cylinder profile).

- ❑ Wear non-slip gloves.

-
5. Remove the tool and cover.
 6. Insert the hexagonal wrench into the hole provided until it stops.
 7. Turn the hex wrench 270 degrees counterclockwise.
 8. Pull out the hexagon wrench again.
 9. Pull off the thumb turn.
- ↳ Electronic thumb turn is disassembled.

Installing the escape thumb-turn

- ✓ 1.5 mm hexagonal wrench available.

1. Insert the 1.5 mm hex key into the escape thumb turn.
 5
2. Turn the hex key fully clockwise until it comes to a stop.
↳ Escape thumb turn clicks.
 6
3. Pull out the hexagon wrench again.
4. Place the escape thumb turn on the cylindrical shaft.
 14
5. Hold the cam firmly and turn the escape thumb-turn clockwise until it stops.
 15
6. Insert the 1.5 mm hex key into the escape thumb turn.
 16
7. Turn the 1.5 mm hex key fully counter-clockwise until it will go no further.
↳ Escape thumb turn clicks.
 17
8. Reinstall the cylinder.
 18
9. Tighten the fastening screw.

Re-fitting the electronic thumb-turn

✓ 1.5 mm hexagonal wrench available.

1. Align the thumb turn mount horizontally.



19

2. Attach the thumb turn.



20



21

**NOTE****Use the supplied hexagonal wrench.**

The special tool is supplied with a hexagonal wrench.

- Use this hexagonal wrench to mount and dismount the electronic thumb turn.

-
3. Insert the hexagonal wrench into the hole provided until it stops.



22

4. Turn the hex key 270 degrees clockwise.



23

5. Pull out the hexagon wrench again.



24

6. Put on the cover.



25



26

7. Turn the cover clockwise.



27

↳ The cover snaps into place with one click.

- ↳ The electronic thumb turn is installed.

Functional test

1. Turn and pull the escape thumb-turn to check that it is properly locked in position.
2. Check that you can unlock the door with the escape thumb-turn.

- ↳ Escape thumb turn is installed.

6. Help and other information

Information material/documents

<https://www.simons-voss.com/en/documents.html>

<https://www.smartintego.com/int/home/infocenter/documentation>

Technical support

+49 (0) 89 / 99 228 333

Email

support-simonsvoss@allegion.com

si-support-simonsvoss@allegion.com

FAQs

<https://faq.simons-voss.com/otrs/public.pl>

SimonsVoss Technologies GmbH, Feringastr. 4, D-85774
Unterfoehring, Germany

Tables des matières

1. Consignes de sécurité générales 57
2. Utilisation conforme aux dispositions 59
3. Situations de montage 60
4. Montage sur le cylindre monté (déverrouillage dans le sens des aiguilles d'une montre) 61
5. Montage sur le cylindre déposé (déverrouillage dans le sens inverse des aiguilles d'une montre) 62
6. Aide et autres informations 68

1. Consignes de sécurité générales

Mot indicateur: Effets immédiats possibles du non-respect

AVERTISSEMENT: Mort ou blessure grave (possible, mais improbable)
ATTENTION: Dommages matériels ou dysfonctionnements,
NOTE: Peu ou pas



AVERTISSEMENT

Accès bloqué

Toute erreur de montage et/ou de programmation d'un composant peut bloquer l'accès par une porte. La société SimonsVoss Technologies GmbH décline toute responsabilité quant aux conséquences d'un accès bloqué, par exemple, accès pour les personnes blessées ou en danger, dommages matériels ou autres dommages !

Accès bloqué par la manipulation du produit

Si vous modifiez vous-même le produit, des dysfonctionnements peuvent se produire et l'accès peut être bloqué par une porte.

- ❑ Ne changer le produit que lorsque cela est nécessaire et

de la manière décrite dans la documentation.

ATTENTION

Endommagement lié à des liquides

Ce produit contient des composants électroniques et/ou mécaniques susceptibles d'être endommagés par tout type de liquide.

- ❖ Tenez les liquides à l'écart du système électronique.

Endommagement lié à des nettoyeurs agressifs

La surface de ce produit peut être endommagée par des nettoyeurs inappropriés.

- ❖ Utilisez exclusivement des nettoyeurs adaptés aux surfaces plastiques ou métalliques.



NOTE

Utilisation conforme aux dispositions

Les produits SimonsVoss sont exclusivement destinés à

l'ouverture et la fermeture de portes et d'objets similaires.

- ❖ N'utilisez pas les produits SimonsVoss à d'autres fins.

Qualifications requises

L'installation et la mise en service nécessitent des connaissances spécialisées.

- ❖ Seul le personnel qualifié peut installer et mettre en service le produit.

Les modifications et nouveaux développements techniques ne peuvent pas être exclus et peuvent être mis en œuvre sans préavis.

La version allemande est le manuel d'instruction original. Les autres langues (rédaction dans la langue du contrat) sont des traductions des instructions originales.

Lisez et suivez toutes les instructions d'installation, d'installation et de mise en service. Transmettez ces instructions et toutes les instructions de maintenance à l'utilisateur.

2. Utilisation conforme aux dispositions

Le bouton Escape du cylindre numérique AX est doté d'une fonction réglable du sens de rotation. Il remplace le bouton intérieur d'un cylindre confort.

- ❖ Déverrouillage de l'intérieur possible à tout moment

sans support d'identification

- Verrouillage uniquement possible de l'extérieur et uniquement avec un support d'identification.

Le bouton Escape convient aux portes DIN-L et DIN-R. Réglez simplement le sens de rotation à l'état démonté. Les personnes peuvent sortir à tout moment des pièces dotées de cylindres confort et de boutons Escape.

3. Situations de montage

Le montage diffère en fonction de la situation :

Déverrouillage dans le sens des aiguilles d'une montre



Le bouton Escape déverrouille la porte dans le sens des aiguilles d'une montre. Il n'est pas nécessaire de démonter le cylindre (voir *Montage sur le cylindre monté (déverrouillage dans le sens des aiguilles d'une montre) [▶ 61]*).

Déverrouillage dans le sens inverse des aiguilles d'une montre



Le bouton Escape déverrouille la porte dans le sens inverse des aiguilles d'une montre. Démontez le cylindre lors du montage (voir *Montage sur le cylindre déposé (déverrouillage dans le sens inverse des aiguilles d'une*

montre) [▶ 62]).

4. Montage sur le cylindre monté (déverrouillage dans le sens des aiguilles d'une montre)

Démontage du bouton mécanique

✓ Outil spécial disponible.

1. Orientez la poignée horizontalement.



3

2. Mettez l'outil spécial en place.

3. Orientez l'outil spécial de manière que le logo soit parallèle à l'évidement.



4

4. Tournez en même temps l'outil spécial et la poignée dans le sens antihoraire.

5. Retirez en même temps l'outil spécial et la poignée.

↳ La poignée mécanique est démontée.

Montage du bouton Escape

✓ Clé à six pans 1,5 mm disponible.

1. Insérez la clé à six pans de 1,5 mm dans le bouton Escape.



5

2. Tournez la clé à six pans dans le sens horaire jusqu'en butée.

↳ Le bouton Escape émet un clic.



6

3. Retirez la clé à six pans.

4. Placez le bouton Escape sur la tige du cylindre.



7

5. Tournez le bouton Escape dans le sens horaire jusqu'à ce qu'il s'enclenche.



8

Essai de fonctionnement

1. Tournez et tirez le bouton Escape pour vérifier qu'il est bien enclenché.
2. Vérifiez si vous pouvez déverrouiller la porte avec le bouton Escape.

↳ Le bouton Escape est monté.

5. Montage sur le cylindre déposé (déverrouillage dans le sens inverse des aiguilles d'une montre)

Démontage du bouton mécanique

- ✓ Outil spécial disponible.

1. Orientez la poignée horizontalement.



3

2. Mettez l'outil spécial en place.
3. Orientez l'outil spécial de manière que le logo soit parallèle à l'évidement.



4

4. Tournez en même temps l'outil spécial et la poignée dans le sens antihoraire.
 5. Retirez en même temps l'outil spécial et la poignée.
- ↳ La poignée mécanique est démontée.

Démontage du cylindre

1. Dévissez la vis de maintien.
2. Démontez le cylindre.



11

Démontage du bouton électronique

- ✓ Outil spécial disponible.
 - ✓ Clé à six pans 1,5 mm disponible.
1. Orientez la poignée horizontalement.
 2. Mettez l'outil spécial en place.
 3. Orientez l'outil spécial de manière que le logo soit parallèle à l'évidement.

4. Tenez fermement l'outil spécial et le cache de la poignée, puis faites tourner les deux d'abord de 1 à 2° dans le sens des aiguilles d'une montre, puis dans le sens inverse.



NOTE

Glisser en tournant

La surface du capuchon de bouton peut être glissante et le capuchon peut être difficile à tourner (en particulier avec les versions WP, reconnaissables à la bague bleue du col du cylindre ou au marquage au laser sur le côté intérieur du profilé du cylindre).

- Portez des gants antidérapants.

-
5. Retirez l'outil et le cache.
 6. Enfoncez la clé six pans dans l'orifice prévu à cet effet jusqu'en butée.
 7. Tournez la clé à six pans de 270 degrés dans le sens antihoraire.
 8. Retirez la clé à six pans.
 9. Retirez la poignée.

↳ Le bouton électronique est démonté.

Montage du bouton Escape

✓ Clé à six pans 1,5 mm disponible.

1. Insérez la clé à six pans de 1,5 mm dans le bouton Escape.



2. Tournez la clé à six pans dans le sens horaire jusqu'en butée.

↳ Le bouton Escape émet un clic.



3. Retirez la clé à six pans.
4. Placez le bouton Escape sur la tige du cylindre.



5. Tenez fermement le panneton de fermeture et tournez le bouton Escape dans le sens horaire jusqu'en butée.



6. Insérez la clé à six pans de 1,5 mm dans le bouton Escape.



7. Tournez la clé à six pans de 1,5 mm dans le sens antihoraire jusqu'en butée.

↳ Le bouton Escape émet un clic.



17

8. Remontez le cylindre.



18

9. Revissez la vis de maintien.

Remontage du bouton électronique

- ✓ Clé à six pans 1,5 mm disponible.

1. Orientez le logement du bouton horizontalement.



19

2. Mettez la poignée en place.



20



21



NOTE

Utiliser la clé à six pans fournie

Une clé à six pans est livrée avec l'outil spécial.

- Utilisez cette clé à six pans pour monter et démonter la poignée électronique.

3. Enfoncez la clé six pans dans l'orifice prévu à cet effet

jusqu'en butée.



22

4. Tournez la clé à six pans de 270 degrés dans le sens horaire.



23

5. Retirez la clé à six pans.



24

6. Mettez le cache en place.



25



26

7. Tournez le cache dans le sens horaire.



27

↳ Le cache s'enclenche avec un déclic.

↳ Le bouton électronique est monté.

Essai de fonctionnement

1. Tournez et tirez le bouton Escape pour vérifier qu'il est bien enclenché.
2. Vérifiez si vous pouvez déverrouiller la porte avec le bouton Escape.

↳ Le bouton Escape est monté.

6. Aide et autres informations

Documentation/documents

<https://www.simons-voss.com/fr/documents.html>

<https://www.smartintego.com/fr/home/infocenter/documentations>

Assistance technique

+49 (0) 89 / 99 228 333

E-Mail

support-simonsvoss@allegion.com

si-support-simonsvoss@allegion.com

FAQ

<https://faq.simons-voss.com/otrs/public.pl>

SimonsVoss Technologies GmbH, Feringastr. 4, D-85774
Unterfoehring, Allemagne

Inhoudsopgave

1.	Algemene veiligheidsinstructies.....	70
2.	Beoogd gebruik.....	72
3.	Inbouwsituaties.....	73
4.	Montage op ingebouwde cilinder (rechtsom ontgren- delen).....	74
5.	Montage op uitgebouwde cilinder (linksom ontgren- delen)	75
6.	Hulp en verdere informatie	80

1. Algemene veiligheidsinstructies

Signaalwoord: Mogelijke onmiddellijke gevolgen van niet-naleving

WAARSCHUWING: Dood of ernstig letsel (mogelijk, maar onwaarschijnlijk)**LET OP:** Materiële schade of storing, **OPMERKING:** Laag of nee



WAARSCHUWING

Geblokkeerde toegang

Door foutief geïnstalleerde en/of geprogrammeerde componenten kan de doorgang door een deur geblokkeerd blijven. Voor gevolgen van een geblokkeerde toegang tot gewonden of personen in gevaar, materiële of andere schade, is SimonsVoss Technologies GmbH niet aansprakelijk.

Geblokkeerde toegang als gevolg van manipulatie van het product

Als u het product zelf wijzigt, kunnen er storingen optreden en kan de toegang worden geblokkeerd door een deur.

- ❖ Vervang het product alleen wanneer dat nodig is en op

de manier die in de documentatie wordt beschreven.

LET OP

Beschadiging door vloeistoffen

Dit product heeft elektronische en/of mechanische componenten die kunnen worden beschadigd door elk type vloeistof.

- Houd vloeistoffen uit de buurt van de elektronica.

Beschadiging door bijtende reinigingsmiddelen

Het oppervlak van dit product kan worden beschadigd door ongeschikte reinigingsmiddelen.

- Maak uitsluitend gebruik van reinigingsmiddelen die geschikt zijn voor kunststof of metalen oppervlakken.



OPMERKING

Beoogd gebruik

SimonsVoss-producten zijn uitsluitend bedoeld voor het

openen en sluiten van deuren en vergelijkbare voorwerpen.

- Gebruik SimonsVoss-producten niet voor andere doeleinden.

Kwalificaties vereist

De installatie en inbedrijfstelling vereist gespecialiseerde kennis. Alleen getraind personeel mag het product installeren en in bedrijf stellen.

Aanpassingen of nieuwe technische ontwikkelingen kunnen niet uitgesloten worden en worden gerealiseerd zonder aankondiging.

De Duitse taalversie is de originele handleiding. Andere talen (opstellen in de contracttaal) zijn vertalingen van de originele instructies.

Lees en volg alle installatie-, installatie- en inbedrijfstellingsinstructies. Geef deze instructies en eventuele onderhoudsinstructies door aan de gebruiker.

2. Beoogd gebruik

De Escape-knop voor de digitale cilinder AX is voorzien van een ratelfunctie. Hij vervangt de binnenknop van een comfortcilinder.

- Openen van binnenuit altijd zonder identificatiemedium

mogelijk

- Afsluiten alleen van buitenaf en alleen met identificatiemedium mogelijk.

De Escape-knop is geschikt voor zowel DIN-L- als DIN-R-deuren. Stel de draairichting eenvoudig in gedemonteerde toestand in.

Personen kunnen op elk gewenst moment vluchten uit ruimten die zijn uitgerust met comfortcilinders en escape-knoppen.

3. Inbouwsituaties

Afhankelijk van de inbouwsituatie verschilt de montage:
rechtsom ontgrendelen



1

De escape-knop ontgrendelt de deur rechtsom. De cilinder hoeft niet gedemonteerd te worden (zie *Montage op ingebouwde cilinder (rechtsom ontgrendelen)* [► 74]).

linksom ontgrendelen



2

De escape-knop ontgrendelt de deur linksom. Demonteer de cilinder tijdens de montage (zie *Montage op uitgebouwde cilinder (linksom ontgrendelen)* [► 75]).

4. Montage op ingebouwde cilinder (rechtsom ontgrendelen)

Mechanische knop demonteren

✓ Speciaal gereedschap beschikbaar.

1. Richt de knop horizontaal uit.



3

2. Plaats het speciale gereedschap.

3. Zet het speciale gereedschap dusdanig op de knop dat het logo parallel is met de inkeping.



4

4. Draai het speciale gereedschap en de knop tegelijkertijd linksom.

5. Trek het speciale gereedschap en de knop tegelijkertijd van de deur.

↳ Mechanische knop is gedemonteerd.

Escape-knop monteren

✓ 1,5 mm inbussleutel beschikbaar.

1. Steek de inbussleutel van 1,5 mm in de Escape-knop.



5

2. Draai de inbussleutel volledig tot de aanslag rechtsom.

↳ Escape-knop klikt.



6

3. Trek de inbussleutel weer uit de opening.
4. Steek de escape-knop op de cilinderschacht.



7

5. Draai de escape-knop rechtsom tot hij vastklikt.



8

Functietest

1. Draai en trek aan de escape-knop om te controleren of deze goed vastzit.
 2. Controleer of u met de escape-knop de deur kunt openen.
- ↳ Escape-knop is gemonteerd.

5. Montage op uitgebouwde cilinder (linksom ontgrendelen)

Mechanische knop demonteren

- ✓ Speciaal gereedschap beschikbaar.

1. Richt de knop horizontaal uit.



3

2. Plaats het speciale gereedschap.
3. Zet het speciale gereedschap dusdanig op de knop dat

het logo parallel is met de inkeping.



4. Draai het speciale gereedschap en de knop tegelijkertijd linksom.
5. Trek het speciale gereedschap en de knop tegelijkertijd van de deur.

↳ Mechanische knop is gedemonteerd.

Cilinder uitbouwen

1. Schroef de stiftschroef los.
2. Demonteer de cilinder.



Elektronische knop demonteren

- ✓ Speciaal gereedschap beschikbaar.
- ✓ 1,5 mm inbussleutel beschikbaar.

1. Richt de knop horizontaal uit.
2. Plaats het speciale gereedschap.
3. Zet het speciale gereedschap dusdanig op de knop dat het logo parallel is met de inkeping.
4. Houd het speciale gereedschap en het knopkapje tegelijkertijd vast en draai ze allebei eerst 1-2° rechtsom en

vervolgens linksom weg.



OPMERKING

Uitgliden bij het draaien

Het oppervlak van de knopdop kan glad zijn en de dop kan moeilijk te draaien zijn (vooral bij WP-versies, herkenbaar aan de blauwe cilinderhalsring of de gelaserde markering aan de binnenkant van het cilinderprofiel).

❑ Draag antisliphandschoenen.

-
5. Neem het gereedschap en de kap weg.
 6. Steek de inbussleutel tot de aanslag in de hiervoor bestemde opening.
 7. Draai de inbussleutel 270 graden linksom.
 8. Trek de inbussleutel weer uit de opening.
 9. Trek de knop van de deur.
- ↳ Elektronische knop is gedemonteerd.

Escape-knop monteren

✓ 1,5 mm inbussleutel beschikbaar.

1. Steek de inbussleutel van 1,5 mm in de Escape-knop.



2. Draai de inbussleutel volledig tot de aanslag rechtsom.

↳ Escape-knop klikt.



3. Trek de inbussleutel weer uit de opening.

4. Steek de escape-knop op de cilinderschacht.



5. Houd de meenemer vast en draai de escape-knop tot de aanslag rechtsom.



6. Steek de inbussleutel van 1,5 mm in de Escape-knop.



7. Draai de inbussleutel van 1,5 mm volledig tot de aanslag linksom.

↳ Escape-knop klikt.



8. Monteer de cilinder weer.



9. Schroef de stiftschroef vast.

Elektronische knop weer monteren

✓ 1,5 mm inbussleutel beschikbaar.

1. Lijn de knophouder horizontaal uit.



19

2. Breng de knop aan.



20



21

**OPMERKING****Gebruik de meegeleverde inbussleutel.**

Met het speciale gereedschap wordt ook een inbussleutel meegeleverd.

- Gebruik deze inbussleutel om de elektronische knop te monteren en te demonteren.

-
3. Steek de inbussleutel tot de aanslag in de hiervoor bestemde opening.



22

4. Draai de inbussleutel 270 graden rechtsom.



5. Trek de inbussleutel weer uit de opening.



6. Breng het kapje aan.



7. Draai het kapje rechtsom.



↳ Het kapje klikt hoorbaar vast.

- ↳ Elektronische knop is gemonteerd.

Functietest

1. Draai en trek aan de escape-knop om te controleren of deze goed vastzit.
2. Controleer of u met de escape-knop de deur kunt openen.

- ↳ Escape-knop is gemonteerd.

6. Hulp en verdere informatie

Informatiemateriaal/documenten

<https://www.simons-voss.com/nl/documenten.html>

<https://www.smartintego.com/int/home/infocenter/>

documentation

Technische Support

+49 (0) 89 / 99 228 333

E-mail

support-simonsvoss@allegion.com

si-support-simonsvoss@allegion.com

FAQ

<https://faq.simons-voss.com/otrs/public.pl>

SimonsVoss Technologies GmbH, Feringastr. 4, 85774
Unterföhring, Duitsland

Sommarario

1. Avvisi di sicurezza generali 83
2. Impiego conforme 85
3. Situazioni di installazione 86
4. Montaggio su cilindro montato (sblocco in senso orario) 87
5. Montaggio su cilindro smontato (sblocco in senso antiorario) 88
6. Supporto e ulteriori informazioni 93

1. Avvisi di sicurezza generali

Parola segnale: Possibili effetti immediati di non conformità

AVVERTENZA: Morte o lesioni gravi (possibili, ma improbabili)

AVVISO: Danni materiali o malfunzionamento, **NOTA:**

Basso o no



AVVERTENZA

Accesso bloccato

Con componenti montati e/o programmati in modo difettoso, l'accesso attraverso una porta può restare bloccato. La SimonsVoss Technologies GmbH non risponde delle conseguenze di un accesso bloccato, per esempio nel caso si debba accedere a persone ferite o in pericolo, di danni a cose o altri danni!

Accesso bloccato tramite manipolazione del prodotto

Se si modifica il prodotto da solo, possono verificarsi malfunzionamenti e l'accesso attraverso una porta può essere bloccato.

- ❑ Modificare il prodotto solo quando necessario e solo nel

modo descritto nella documentazione.

AVVISO

Danni dovuti a fluidi

Il presente prodotto contiene componenti elettronici e/o meccanici che potrebbero subire danni dovuti a liquidi di qualunque tipo.

- ❑ Tenere i componenti elettronici lontani da liquidi.

Danni dovuti a detersivi aggressivi

La superficie di questo prodotto può essere danneggiata da detersivi non idonei.

- ❑ Utilizzare esclusivamente detersivi adatti a superfici in plastica o metallo.



NOTA

Uso conforme

I prodotti SimonsVoss sono concepiti esclusivamente per

l'apertura e la chiusura di porte e oggetti simili.

- ❖ Non utilizzare i prodotti SimonsVoss per altri scopi.

Qualifiche richieste

L'installazione e la messa in servizio richiedono conoscenze specialistiche.

- ❖ Solo personale qualificato può installare e mettere in servizio il prodotto.

Non si escludono modifiche o perfezionamenti tecnici, anche senza preavviso.

La versione in lingua tedesca è il manuale di istruzioni originale. Altre lingue (redazione nella lingua del contratto) sono traduzioni delle istruzioni originali.

Leggere e seguire tutte le istruzioni di installazione, installazione e messa in servizio. Passare queste istruzioni e tutte le istruzioni di manutenzione all'utente.

2. Impiego conforme

Il pomolo Escape per il cilindro digitale AX è dotato di una funzione di cricchetto. Sostituisce il pomolo interno di un cilindro Comfort.

- ❖ Sblocco dall'interno possibile in qualsiasi momento senza mezzo di identificazione

- ❖ Chiusura possibile solo dall'esterno e solo con un mezzo di identificazione.

Il pomolo Escape è adatto a entrambe le porte DIN sx e DIN dx. È sufficiente impostare il senso di rotazione nello stato smontato.

Le persone possono fuggire dalle stanze dotate di cilindri Comfort e pomoli Escape in qualsiasi momento.

3. Situazioni di installazione

Il montaggio differisce a seconda della situazione di installazione:

sblocco in senso orario



Il pomolo Escape sblocca la porta in senso orario. Il cilindro non deve essere smontato (vedere *Montaggio su cilindro montato (sblocco in senso orario)* [▶ 87]).

Sblocco in senso antiorario



Il pomolo Escape sblocca la porta in senso antiorario. Smontate il cilindro durante il montaggio (vedere *Montaggio su cilindro smontato (sblocco in senso antiorario)* [▶ 88]).

4. Montaggio su cilindro montato (sblocco in senso orario)

Smontaggio pomolo meccanico

✓ Utensile speciale disponibile.

1. Allineare il pomolo in orizzontale.



2. Fissare l'utensile speciale.

3. Allineare l'utensile speciale in modo che il logo sia parallelo alla scanalatura.



4. Ruotate l'attrezzo speciale e il pomolo simultaneamente in senso antiorario.

5. Estraete l'attrezzo speciale e il pomolo contemporaneamente.

↳ Il pomolo meccanico è smontato.

Montaggio del pomolo Escape

✓ Chiave esagonale da 1,5 mm disponibile.

1. Inserire la chiave esagonale da 1,5 mm nel pomolo Escape.



2. Ruotate la chiave esagonale in senso orario fino all'arre-

sto.

↳ Il pomolo Escape emette un clic.



3. Estrarre di nuovo la chiave esagonale.

4. Inserire il pomolo Escape sullo stelo del cilindro.



5. Ruotate il pomolo Escape in senso orario fino a quando non scatta in posizione.



Prova di funzionamento

1. Girate e tirate il pomolo Escape per verificare che sia inserito correttamente.

2. Accertatevi di poter sbloccare la porta con il pomolo Escape.

↳ Il pomolo Escape è montato.

5. Montaggio su cilindro smontato (sblocco in senso antiorario)

Smontaggio pomolo meccanico

✓ Utensile speciale disponibile.

1. Allineare il pomolo in orizzontale.



2. Fissare l'utensile speciale.
3. Allineare l'utensile speciale in modo che il logo sia parallelo alla scanalatura.



4

4. Ruotate l'attrezzo speciale e il pomolo simultaneamente in senso antiorario.
5. Estraete l'attrezzo speciale e il pomolo contemporaneamente.

↳ Il pomolo meccanico è smontato.

Smontaggio del cilindro

1. Svitare la vite di ritenuta.
2. Rimuovete il cilindro.



11

Smontaggio del pomolo elettronico

- ✓ Utensile speciale disponibile.
 - ✓ Chiave esagonale da 1,5 mm disponibile.
1. Allineare il pomolo in orizzontale.
 2. Fissare l'utensile speciale.
 3. Allineare l'utensile speciale in modo che il logo sia parallelo alla scanalatura.
 4. Afferrare l'utensile speciale e il cappuccio del pomolo contemporaneamente e ruotarli entrambi insieme prima

in senso orario di 1-2° e poi in senso antiorario.



NOTA

Scivolare quando si gira

La superficie del cappuccio della manopola può essere scivolosa e il cappuccio può essere difficile da girare (specialmente con le versioni WP, riconoscibili dall'anello blu del collo del cilindro o dalla marcatura laserata sul lato interno del profilo del cilindro).

■ Indossare guanti antiscivolo.

5. Rimuovere l'utensile e il cappuccio.
 6. Inserire la chiave esagonale nell'apposito foro fino a battuta.
 7. Girare la chiave esagonale di 270 gradi in senso antiorario.
 8. Estrarre di nuovo la chiave esagonale.
 9. Rimuovere il pomolo.
- ↳ Il pomolo elettronico è smontato.

Montaggio del pomolo Escape

✓ Chiave esagonale da 1,5 mm disponibile.

1. Inserire la chiave esagonale da 1,5 mm nel pomolo Escape.



2. Ruotate la chiave esagonale in senso orario fino all'arresto.

↳ Il pomolo Escape emette un clic.



3. Estrarre di nuovo la chiave esagonale.
4. Inserire il pomolo Escape sullo stelo del cilindro.



5. Tenete fermo l'ingegno di chiusura e ruotate il pomolo Escape in senso orario fino all'arresto.



6. Inserire la chiave esagonale da 1,5 mm nel pomolo Escape.



7. Ruotate il chiave esagonale da 1,5 mm in senso antiorario fino all'arresto.

↳ Il pomolo Escape emette un clic.



8. Reinstallate il cilindro.



9. Avvitare saldamente la vite a risvolto.

Rimontaggio del pomolo elettronico

✓ Chiave esagonale da 1,5 mm disponibile.

1. Allineare in orizzontale la sede del pomolo.



19

2. Infilare il pomolo.



20



21



NOTA

Utilizzare la chiave esagonale in dotazione

L'utensile speciale viene fornito con una chiave esagonale.

■ Utilizzare questa chiave esagonale per montare e smontare il pomolo elettronico.

3. Inserire la chiave esagonale nell'apposito foro fino a battuta.



22

4. Girare la chiave esagonale di 270 gradi in senso orario.



5. Estrarre di nuovo la chiave esagonale.



6. Infilare il cappuccio.



7. Ruotare il cappuccio in senso orario.



↳ Il cappello scatta con un clic.

- ↳ Il pomolo elettronico è montato.

Prova di funzionamento

1. Girate e tirate il pomolo Escape per verificare che sia inserito correttamente.
 2. Accertatevi di poter sbloccare la porta con il pomolo Escape.
- ↳ Il pomolo Escape è montato.

6. Supporto e ulteriori informazioni

Materiale informativo/Documenti

<https://www.simons-voss.com/it/documenti.html>

<https://www.smartintego.com/int/home/infocenter/>

documentation

Supporto tecnico

+49 (0) 89 / 99 228 333

E-mail

support-simonsvoss@allegion.com

si-support-simonsvoss@allegion.com

FAQ

<https://faq.simons-voss.com/otrs/public.pl>

SimonsVoss Technologies GmbH, Feringastr. 4, D-85774
Unterfoehring, Germania

Indholdsfortegnelse

- | | | |
|----|---|-----|
| 1. | Generelle sikkerhedshenvisninger..... | 96 |
| 2. | Korrekt anvendelse | 98 |
| 3. | Monteringssituationer | 99 |
| 4. | Montage ved monteret cylinder (lås op med uret)
..... | 99 |
| 5. | Montage ved afmonteret cylinder (lås op imod uret)
..... | 101 |
| 6. | Hjælp og flere oplysninger | 106 |

1. Generelle sikkerhedshenvisninger

Signalord: Mulige direkte virkninger i tilfælde af manglende overholdelse

ADVARSEL: Død eller alvorlig personskade (muligt, men usandsynligt) OPMÆRKSOMHED: Materiel skade eller fejlfunktion, BEMÆRK: Lidt eller ingen



ADVARSEL

Spærret adgang

Hvis komponenter er fejlagtigt monteret og/eller programmeret, kan adgang til en dør forblive spærret. For følgeskader, der skyldes spærret adgang, fx til personer, der er sårede eller i fare, tingsskader eller andre skader, hæfter SimonsVoss Technologies GmbH ikke!

Blokeret adgang gennem manipulation af produktet

Hvis du selv ændrer produktet, kan der opstå funktionsfejl, og adgang via en dør kan blokeres.

- Modificer kun produktet, når det er nødvendigt, og kun

på den måde, der er beskrevet i dokumentationen.

OPMÆRKSOMHED

Beskadigelse på grund af væske

Dette produkt indeholder elektroniske og/eller mekaniske komponenter, som kan blive beskadiget på grund af alle typer væsker.

- ❑ Hold væsker væk fra elektronikken.

Beskadigelse på grund af aggressive rengøringsmidler

Produktets overflade kan blive beskadiget på grund af uegnede rengøringsmidler.

- ❑ Brug kun rengøringsmidler, der er velegnede til kunststof- og metaloverflader.



BEMÆRK

Korrekt anvendelse

SimonsVoss-produkter er kun beregnet til åbning og lukning

af døre og sammenlignelige genstande.

- Anvend ikke SimonsVoss-produkter til andre formål.

Krævede kvalifikationer

Installation og idriftsættelse kræver specialiseret viden.

- Kun uddannet personale må installere og idriftsætte produktet.

Ændringer eller tekniske videreudviklinger kan ikke udelukkes og kan foretages uden forudgående varsel.

Den tyske sprogversion er den originale brugsanvisning. Andre sprog (udkast på kontraktsproget) er oversættelser af de originale instruktioner.

Læs og følg alle installations-, installations- og idriftsættelsesinstruktioner. Overfør disse instruktioner og eventuel vedligeholdelsesinstruktion til brugeren.

2. Korrekt anvendelse

Escape-knopgrebet til den digitale cylinder AX er forsynet med låsefunktion. Det erstatter komfortcylinderens indvendige knopgreb.

- Frigørelse altid mulig inde fra uden identifikationsmedium
- Det er kun muligt at låse ude fra og kun med

identifikationsmedium.

Escape-knopgrebet egner sig både til DIN-L- samt til DIN-R-døre. Drejeretningen indstilles nemt i afmonteret tilstand. Personer kan altid flygte ud af lokaler, der er forsynet med komfortcylindre og Escape-knopgreb.

3. Monteringsituationer

Afhængigt af monteringsituationen ligger forskellen i montagen:

Lås op med uret



Escape-knopgrebet låser døren op med uret. Cylinderen skal ikke afmonteres (se *Montage ved monteret cylinder (lås op med uret)* [▶ 99]).

Lås op mod uret



Escape-knopgrebet låser døren op mod uret. Afmonter cylinderen under montagen (se *Montage ved afmonteret cylinder (lås op imod uret)* [▶ 101]).

4. Montage ved monteret cylinder (lås op med uret)

Afmontering af mekanisk knopgreb

- ✓ Anvend specialværktøj.

4. Montage ved monteret cylinder (lås op med uret) 100 / 120 | DK

1. Ret knoppen op vandret.



2. Anbring specialværktøjet.
3. Vend specialværktøjet, så logoet er parallelt med udsparingen.



4. Drej samtidig specialværktøjet og knoppen imod urets retning.
5. Træk specialværktøjet og knoppen af samtidig.

↳ Den mekaniske knop er afmonteret.

Montering af Escape-knopgreb

✓ Anvend 1,5 mm unbrakonøgle.

1. Stik 1,5 mm unbrakonøglen i Escape-knopgrebet.



2. Drej unbrakonøglen med uret indtil anslag.

↳ Escape-knopgreb klikker.



3. Træk unbrakonøglen ud igen.
4. Anbring Escape-grebet på cylinderskafte.



5. Drej Escape-knopgrebet med uret, indtil det klikker på

plads.



8

Funktionstest

1. Drej og træk i Escape-knopgrebet for at bekræfte, om det er klikket korrekt på plads.
2. Kontrollér, om døren kan låses op med Escape-knopgrebet.

↳ Escape-knopgreb er monteret.

5. Montage ved afmonteret cylinder (lås op imod uret)

Afmontering af mekanisk knopgreb

✓ Anvend specialværktøj.

1. Ret knoppen op vandret.



3

2. Anbring specialværktøjet.
3. Vend specialværktøjet, så logoet er parallelt med udsparingen.



4

4. Drej samtidig specialværktøjet og knoppen imod urets retning.
5. Træk specialværktøjet og knoppen af samtidig.

↳ Den mekaniske knop er afmonteret.

Afmontering af cylinder

1. Skru cylindersikringssskruen ud.
2. Afmonter cylinderen.



11

Afmontering af elektronisk knopgreb

- ✓ Anvend specialværktøj.
- ✓ Anvend 1,5 mm unbrakonøgle.

1. Ret knoppen op vandret.
2. Anbring specialværktøjet.
3. Vend specialværktøjet, så logoet er parallelt med udsparingen.
4. Hold fast i specialværktøjet og knopkappen samtidigt, og drej begge først 1-2^o med uret og derefter væk imod uret.



BEMÆRK

Glider når du drejer



Overfladen på knapkappen kan være glat, og hættten kan

være vanskelig at dreje (især med WP-versioner, som genkendes af den blå cylinderhalsring eller den laserede markering på indersiden af cylinderprofilen).

❑ Bær handsker uden skridsikkerhed.

5. Træk værktøjet og kappen af.
 6. Stik unbrakonøglen i det dertil beregnede hul indtil anslag.
 7. Drej unbrakonøglen 270 grader mod uret.
 8. Træk unbrakonøglen ud igen.
 9. Træk knoppen af.
- ↳ Elektronisk knopgreb er afmonteret.

Montering af Escape-knopgreb

- ✓ Anvend 1,5 mm unbrakonøgle.
1. Stik 1,5 mm unbrakonøglen i Escape-knopgrebet.
 5
 2. Drej unbrakonøglen med uret indtil anslag.
↳ Escape-knopgreb klikker.
 6
 3. Træk unbrakonøglen ud igen.
 4. Anbring Escape-grebet på cylinderskaftet.
 14

5. Hold fast i låsekammen, og drej Escape-knopgrebet med uret indtil anslag.



15

6. Stik 1,5 mm unbrakonøglen i Escape-knopgrebet.



16

7. Drej 1,5 mm unbrakonøglen imod uret indtil anslag.

↳ Escape-knopgreb klikker.



17

8. Montér cylinderen igen.



18

9. Spænd cylindersikringskruen.

Montering af elektronisk knopgreb igen

- ✓ Anvend 1,5 mm unbrakonøgle.

1. Ret knopgrebets holder op vandret.



19

2. Montér knoppen.



20

**BEMÆRK****Anvend den medfølgende unbrakonøgle**

Der medfølger også en unbrakonøgle med specialværktøjet.

- Anvend denne unbrakonøgle for at montere og afmontere den elektroniske knop.

-
3. Stik unbrakonøglen i det dertil beregnede hul indtil anslag.



4. Drej unbrakonøglen 270 grader med uret.



5. Træk unbrakonøglen ud igen.



6. Montér kappen.



7. Drej kappen med uret.



↳ Kappen går hørbart i hak.

↳ Elektronisk knopgreb er monteret.

Funktionstest

1. Drej og træk i Escape-knopgrebet for at bekræfte, om det er klikket korrekt på plads.
2. Kontrollér, om døren kan låses op med Escape-knopgrebet.

↳ Escape-knopgreb er monteret.

6. Hjælp og flere oplysninger

Infomateriale/dokumenter

<https://www.simons-voss.com/dk/dokumenter.html>

<https://www.smartintego.com/int/home/infocenter/documentation>

Teknisk support

+49 (0) 89 / 99 228 333

e-mail

support-simonsvoss@allegion.com

si-support-simonsvoss@allegion.com

FAQ

<https://faq.simons-voss.com/otrs/public.pl>

SimonsVoss Technologies GmbH, Feringastr. 4, D-85774
Unterföhring, Tyskland

Innehållsförteckning

1. Allmänna säkerhetsanvisningar 108
2. Avsedd användning 110
3. Monteringssituationer 111
4. Montering på monterad cylinder (upplåsning med-
urs) 111
5. Montering på demonterad cylinder (upplåsning
moturs) 113
6. Hjälp och ytterligare information..... 118

1. Allmänna säkerhetsanvisningar

Signalord: Eventuella omedelbara effekter av bristande efterlevnad

WARNING: Död eller allvarlig skada (möjligt, men osannolikt)OBS: Skador på egendom eller fel, INFO: Låg eller ingen



WARNING

Tillgång spärrad

Felaktigt installerade och/eller programmerade komponenter kan leda till att dörrar spärras. SimonsVoss Technologies GmbH ansvarar inte för konsekvenserna av felaktig installation såsom spärrat tillträde till skadade personer eller personer i risksituationer, materiella skador eller andra typer av skador.

Blockerad åtkomst genom manipulering av produkten

Om du ändrar produkten på egen hand kan fel uppstå och åtkomst via en dörr kan blockeras.

- Ändra endast produkten vid behov och endast på det

sätt som beskrivs i dokumentationen.

OBS

Skada på grund av vätskor

Den här produkten innehåller elektroniska och/eller mekaniska komponenter som kan skadas av alla typer av vätskor.

- ❑ Låt inte elektroniken komma i kontakt med vätskor.

Skada på grund av aggressiva rengöringsmedel

Ytan på den här produkten kan skadas om olämpliga rengöringsmedel används.

- ❑ Använd endast rengöringsmedel som lämpar sig för plast- och metallytor.



INFO

Avsedd användning

SimonsVoss-produkter är uteslutande avsedda för öppning och stängning av dörrar och liknande.

- ❑ Använd inte SimonsVoss-produkter för andra syften.

Kvalifikationer krävs

Installation och idrifttagning kräver specialiserad kunskap.

- Endast utbildad personal får installera och driftsätta produkten.

Ändringar eller teknisk vidareutveckling kan inte uteslutas och kan komma att genomföras utan föregående meddelande om detta.

Den tyska språkversionen är den ursprungliga bruksanvisningen. Andra språk (utarbetade på kontraktsspråket) är översättningar av originalinstruktionerna.

Läs och följ alla installations-, installations- och driftsinstruktioner. Skicka dessa instruktioner och alla underhållsinstruktioner till användaren.

2. Avsedd användning

Escape-knappen för Digital Cylinder AX är utrustad med en spärrfunktion. Den ersätter innerknoppen till en Comfortcylinder.

- Upplåsning inifrån är alltid möjlig utan identifikationsmedium.
- Låsning är bara möjlig utifrån och endast med identifikationsmedium.

Escape-knoppen passar både till DIN L- och DIN R-dörrar. Du ställer enkelt in vridriktningen i demonterat tillstånd. Personer kan allt ta sig ut från utrymmen som är utrustade med Comfortcylinder och Escape-knopp.

3. Monteringssituationer

Monteringen skiljer sig åt beroende på monteringsituation:

Upplåsning medurs



1

Escape-knoppen låser upp dörren medurs. Cylindern behöver inte demonteras (se *Montering på monterad cylinder (upplåsning medurs)* [▶ 111]).

Upplåsning moturs



2

Escape-knoppen låser upp dörren moturs. Demontera cylindern vid montering (se *Montering på demonterad cylinder (upplåsning moturs)* [▶ 113]).

4. Montering på monterad cylinder (upplåsning medurs)

Demontera mekanisk knopp

✓ Specialverktyg finns.

1. Rikta in knoppen horisontellt.



3

2. Sätt på specialvertyget.

3. Rikta in specialvertyget så att logotypen är parallell med ursparningen.



4

4. Vrid specialvertyget och knappen samtidigt moturs.

5. Dra bort specialvertyget och knappen samtidigt.

- ↳ Den mekaniska knappen är demonterad.

Montera Escape-knopp

- ✓ 1,5 mm sexkantsnyckel finns.

1. Sätt i 1,5 mm insexnyckeln i Escape-knopp.



5

2. Vrid knoppen medurs med insexnyckeln till anslaget.

- ↳ Escape-knoppen klickar.



6

3. Dra ut sexkantsnyckeln igen.

4. Sätt på Escape-knopen på cylinderskaftet.



7

5. Vrid Escape-knopen medurs så att den hakar i.





8

Funktionstest

1. Vrid och dra i Escape-knappen för att säkerställa att den sitter korrekt.
 2. Kontrollera att du kan låsa upp dörren med Escape-knappen.
- ↳ Escape-knappen är monterad.

5. Montering på demonterad cylinder (upplåsning moturs)

Demontera mekanisk knapp

- ✓ Specialverktyg finns.
1. Rikta in knoppen horisontellt.
 3
 2. Sätt på specialverktyget.
 3. Rikta in specialverktyget så att logotypen är parallell med ursparningen.
 4
 4. Vrid specialverktyget och knappen samtidigt moturs.
 5. Dra bort specialverktyget och knappen samtidigt.
- ↳ Den mekaniska knappen är demonterad.

Demontera cylinder

1. Skruva ur cylinderskruven.
2. Demontera cylindern.



Demontera elektronisk knapp

- ✓ Specialverktyg finns.
- ✓ 1,5 mm sexkantsnyckel finns.

1. Rikta in knoppen horisontellt.
2. Sätt på specialverktyget.
3. Rikta in specialverktyget så att logotypen är parallell med ursparningen.
4. Håll fast specialverktyget och knapplocket och vrid dem båda tillsammans, först 1–2° medurs och sedan bort moturs.



INFO

Halkar när du vrider



Ytan på vredskåpan kan vara hal och locket kan vara svårt att vrida (speciellt med WP-versioner, kännbar igenom den

blå cylinderhalsringen eller den laserade markeringen på inre sidan av cylinderprofilen).

- Använd halkfria handskar.

-
5. Dra bort verktyget och kåpan.
 6. Sätt i sexkantsnyckeln till anslag i det avsedda hålet.
 7. Vrid sexkantsnyckeln 270 grader moturs.
 8. Dra ut sexkantsnyckeln igen.
 9. Dra av knoppen.
- ↳ Den elektroniska knoppen är demonterad.

Montera Escape-knopp

- ✓ 1,5 mm sexkantsnyckel finns.
1. Sätt i 1,5 mm insexnyckeln i Escape-knoppen.
 5
 2. Vrid knoppen medurs med insexnyckeln till anslaget.
↳ Escape-knoppen klickar.
 6
 3. Dra ut sexkantsnyckeln igen.
 4. Sätt på Escape-knopen på cylindern.
 -  14
 5. Håll fast låsbiten och vrid Escape-knopen medurs till

anslaget.



6. Sätt i 1,5 mm insexnyckeln i Escape-knoppen.



7. Vrid 1,5 mm insexnyckeln moturs till anslaget.

↳ Escape-knoppen klickar.



8. Montera cylindern igen.



9. Skruva fast cylinderskruven.

Återmontera elektronisk knapp

- ✓ 1,5 mm sexkantsnyckel finns.

1. Rikta in knappfästet horisontellt.



2. Sätt på knoppen.





21

**INFO****Använd den medföljande sexkantsnyckeln.**

I leveransomfånget till specialverkyget ingår även en sexkantsnyckel.

- Använd den här sexkantsnyckeln för att montera och demontera den elektroniska knoppen.

3. Sätt i sexkantsnyckeln till anslag i det avsedda hålet.



22

4. Vrid sexkantsnyckeln 270 grader medurs.



23

5. Dra ut sexkantsnyckeln igen.



24

6. Sätt på kåpan.



25



26

7. Vrid kåpan medurs.



27

↳ Kåpan hakar i med ett klick.

↳ Den elektroniska knoppen är monterad.

Funktionstest

1. Vrid och dra i Escape-knoppen för att säkerställa att den sitter korrekt.
2. Kontrollera att du kan låsa upp dörren med Escape-knappen.

↳ Escape-knoppen är monterad.

6. Hjälp och ytterligare information

Infomaterial/dokument

<https://www.simons-voss.com/se/dokument.html>

<https://www.smartintego.com/int/home/infocenter/documentation>

Teknisk support

+49 (0) 89 / 99 228 333

support-simonsvoss@allegion.com

si-support-simonsvoss@allegion.com

FAQ

<https://faq.simons-voss.com/otrs/public.pl>

SimonsVoss Technologies GmbH, Feringastr. 4, D-85774
Unterföhring, Tyskland

Simons  **Voss**
technologies

Made in Germany

A BRAND OF



ALLEGION[™]