

30
60



DE | Kurzanleitung
EN | Quick Guide
FR | Guide abrégé
DK | Kort vejledning

Cylinder AX Modularity

ZS50.99050006

31.08.2022

Simons Voss
technologies

deutsch	3
english	46
français	87

Inhaltsverzeichnis

1	Allgemeine Sicherheitshinweise.....	4
2	Produktspezifische Sicherheitshinweise.....	6
3	Zubehör und Werkzeuge.....	6
4	Cylinder AX verlängern.....	8
5	Cylinder AX verkürzen.....	18
6	CO-Zylinder zu FD kombinieren	27
7	CO-Zylinder zu HZ reduzieren.....	36
8	Hilfe und weitere Informationen.....	44

1 Allgemeine Sicherheitshinweise

Signalwörter
(ANSI
Z535.6)

Gefahr: Tod oder schwere Verletzung (wahrscheinlich), Warnung: Tod oder schwere Verletzung (möglich, aber unwahrscheinlich), Vorsicht: Leichte Verletzung, Achtung: Sachschäden oder Fehlfunktionen, Hinweis: Geringe oder keine Schäden



WARNUNG

Versperrter Zugang

Durch fehlerhaft montierte und/oder programmierte Komponenten kann der Zutritt durch eine Tür versperrt bleiben. Für Folgen eines versperrten Zutritts wie Zugang zu verletzten oder gefährdeten Personen, Sachschäden oder anderen Schäden haftet die SimonsVoss Technologies GmbH nicht!

Versperrter Zugang durch Manipulation des Produkts

Wenn Sie das Produkt eigenmächtig verändern, dann können Fehlfunktionen auftreten und der Zugang durch eine Tür versperrt werden.

- Verändern Sie das Produkt nur bei Bedarf und nur in der Dokumentation beschriebenen Art und Weise.

ACHTUNG

Beschädigung durch Öle, Fette, Farben und Säuren

Dieses Produkt enthält elektronische und/oder mechanische Bauteile, die durch Flüssigkeiten aller Art beschädigt werden können.

- Halten Sie Öle, Fette, Farben und Säuren vom Produkt fern.

Beschädigung durch aggressive Reinigungsmittel

Die Oberfläche dieses Produkts kann durch ungeeignete Reinigungsmittel beschädigt werden.

- Verwenden Sie ausschließlich Reinigungsmittel, die für Kunststoff- bzw. Metalloberflächen geeignet sind.



HINWEIS

Bestimmungsgemäßer Gebrauch

SimonsVoss-Produkte sind ausschließlich für das Öffnen und Schließen von Türen und vergleichbaren Gegenständen bestimmt.

- Verwenden Sie SimonsVoss-Produkte nicht für andere Zwecke.

Qualifikationen erforderlich

Die Installation und Inbetriebnahme setzt Fachkenntnisse voraus.

- Nur geschultes Fachpersonal darf das Produkt installieren und in Betrieb nehmen.

Änderungen bzw. technische Weiterentwicklungen können nicht ausgeschlossen und ohne Ankündigung umgesetzt werden.

Die deutsche Sprachfassung ist die Originalbetriebsanleitung. Andere Sprachen (Abfassung in der Vertragssprache) sind Übersetzungen der Originalbetriebsanleitung.

Lesen Sie alle Anweisungen zur Installation, zum Einbau und zur Inbetriebnahme und befolgen Sie diese. Geben Sie diese Anweisungen und jegliche Anweisungen zur Wartung an den Benutzer weiter.

2 Produktspezifische Sicherheitshinweise



WARNUNG

Störung der Antipanikfunktion durch unzulässige Manipulation

Die Länge des Digital Cylinder AX kann auf der Innenseite ab 50 mm verändert werden. Wenn die AP-Seite demontiert wird, kann die Antipanikeinheit beschädigt werden.

- Verändern Sie die Länge auf der AP-Seite nicht.

3 Zubehör und Werkzeuge

Der Profilylinder kann mit folgenden Teilen verlängert und verkürzt werden:

Verlängerungsbolzen	Kernverlängerung des Profils	Profilverlängerung
 <ul style="list-style-type: none"> ■ Z5.BOLT.XX (XX=Gewünschte Grundlänge) 	 <ul style="list-style-type: none"> ■ Z5.CORE.05: 5 mm ■ Z5.CORE.10: 10 mm ■ Z5.CORE.20: 20 mm 	 <ul style="list-style-type: none"> ■ Z5.PROFILE.05: 5 mm ■ Z5.PROFILE.10: 10 mm ■ Z5.PROFILE.20: 20 mm

Klammer	Halbzylinder-Mittelstück	Zylinder-Mittelstück
 <p>■ Z5.CLAMPS Ein Set enthält 50 Stück.</p>	 <p>■ Z5.CNT.HZ</p>	 <p>■ Z5.CNT.EU</p>
Mitnehmer (Standard, WP)	Knaufaufnahme innen	
 <p>■ Z5.CAM.WP</p>	 <p>■ Z5.PR.IN</p>	

Dafür benötigen Sie folgendes Werkzeug:

Ausheber (Z5.LIFTER)	Abstandshalter (Z5.SPACER)	Klemmblock (Z5.BLOCK)
		

Das Knauf-Montagewerkzeug des Cylinder AX ist so konstruiert, dass Sie es als Halterung für den Cylinder AX verwenden können. Legen Sie es mit der flachen Seite auf eine ebene Fläche und stellen Sie den

Cylinder AX mit dem Knauf in das Montagewerkzeug.
Das Wieder-Zusammensetzen ist einfacher, wenn der
Cylinder AX in der Halterung steht.

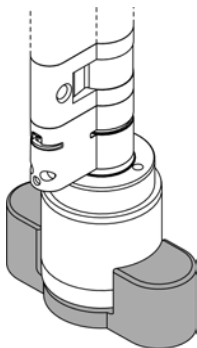

4 Cylinder AX verlängern

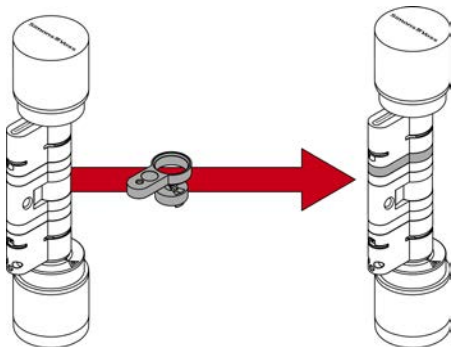

Die Kernverlängerung und die Profilverlängerung müssen gleich lang sein. Zusätzlich benötigen Sie einen Verlängerungsbolzen für die gewünschte Länge.

- ✓ Ausheber zum Lösen der Klammer
- ✓ Abstandshalter zum Ausrichten des Verlängerungsbolzens
- ✓ Klemmblock zum Einpressen der Klammer

1. Stellen Sie den Cylinder AX in das Knauf-Montagewerkzeug.



2. Haken Sie die Spitze des Aushebers in die Klammer ein.

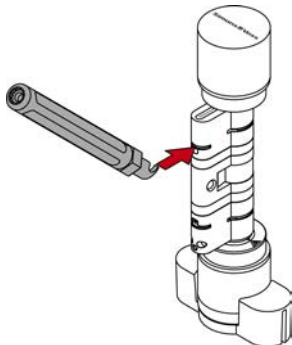

3. Hebeln Sie die Klammer aus dem Profilzylinder, indem Sie den Ausheber in die Mitte des Zylinders bewegen.

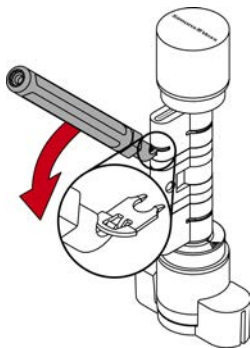

4. Ziehen Sie die Klammer vollständig aus dem Profilzylinder.

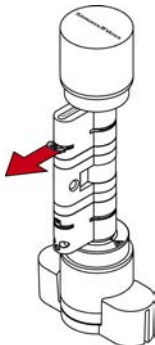

5. Nehmen Sie die beiden Zylinderhälften auseinander.

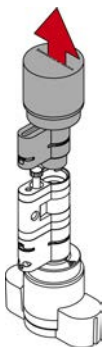

- Schrauben Sie mit dem Ausheber den Verlängerungsbolzen heraus.

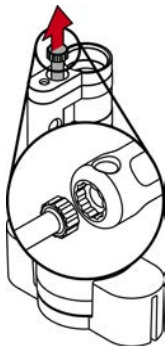

- Setzen Sie passende Kernverlängerungen ein.
- Stecken Sie passende Profilverlängerungen auf.



9. Legen Sie den Abstandshalter an.

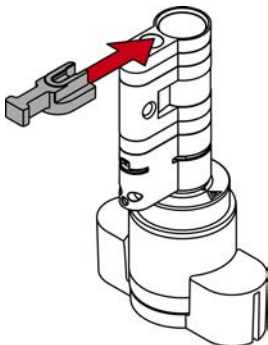

10. Schrauben Sie mit dem Ausheber einen passenden Verlängerungsbolzen ein, bis er am Abstandshalter anliegt.



HINWEIS

Länge auf Bolzenkopf

Sie finden auf dem Bolzenkopf eine Zahl. Diese Zahl ist die Länge des Zylinderprofils, zu dem der Bolzen passt.

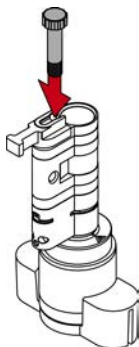

11. Setzen Sie die beiden Zylinderhälften wieder zusammen.

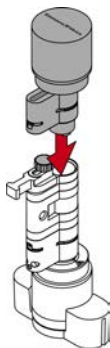

- ↳ Verlängerungsbolzen ist gegen Verdrehen geschützt.

12. Ziehen Sie den Abstandshalter wieder ab.

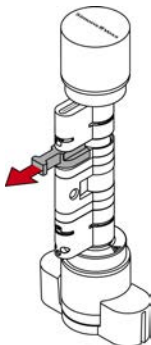

13. Schieben Sie die Hälften vollständig zusammen.

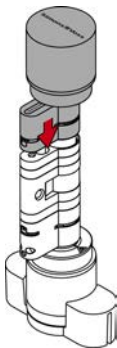

14. Setzen Sie die Klammer mit der Nase zur Stulpschraube wieder in den Schlitz des Profilzylinders ein und drücken Sie die Klammer mit dem Daumen fest, damit sie nicht mehr herausfallen kann.

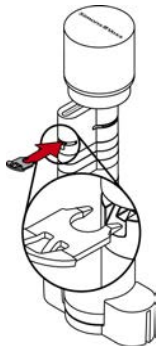

15. Setzen Sie den Zylinder in den Klemmblock ein, so dass der Profilzylinder und der Knauf bündig in den Aussparungen liegen.

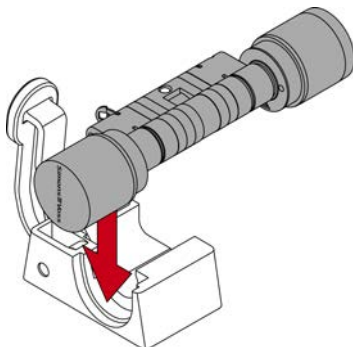

- ↳ Der Hebel des Klemmblocks ist an einer Stelle mit einem Metallplättchen verstärkt. Die vorhin eingeschobene Klammer liegt gegenüber dieses Metallplättchens.
16. Drücken Sie den Hebel des Klemmblocks zur Bodenplatte, bis die Klammer wieder vollständig im Profilzylinder sitzt.

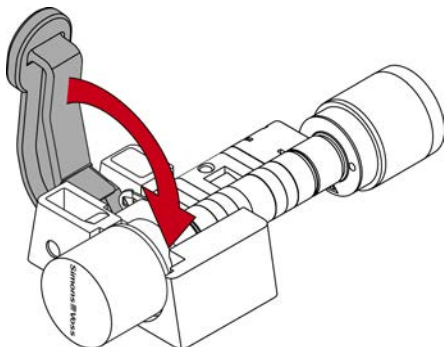

↳ Cylinder AX ist verlängert.

5 Cylinder AX verkürzen

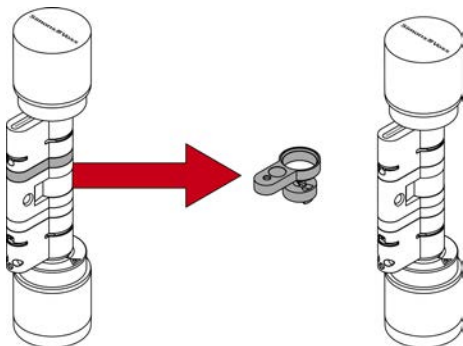

Sie benötigen einen Bolzen für die gewünschte Länge.

- ✓ Ausheber zum Lösen der Klammer
- ✓ Abstandshalter zum Ausrichten des Bolzens

✓ Klemmblock zum Einpressen der Klammer

1. Stellen Sie den Cylinder AX in das Knauf-Montage-
werkzeug.



2. Haken Sie die Spitze des Aushebers in die Klammer
ein.

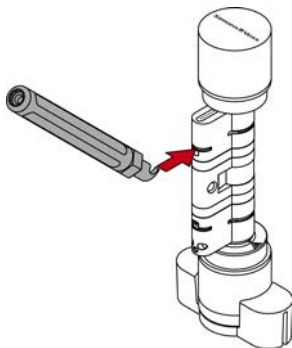

3. Hebeln Sie die Klammer aus dem Profilzylinder, indem Sie den Ausheber in die Mitte des Zylinders bewegen.

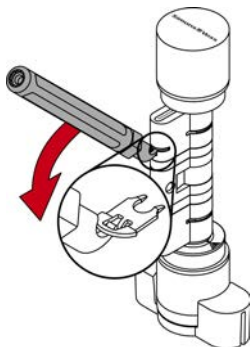

4. Ziehen Sie die Klammer vollständig aus dem Profilzylinder.

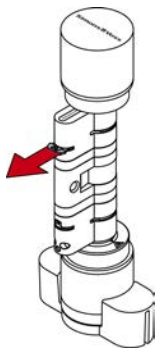

5. Nehmen Sie die beiden Zylinderhälften auseinander.

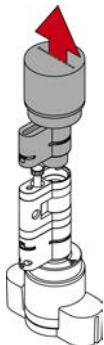

6. Schrauben Sie mit dem Ausheber den Bolzen heraus.

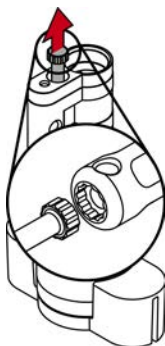

7. Nehmen Sie die Profilverlängerungen ab.

8. Nehmen Sie die Kernverlängerungen ab.



9. Legen Sie den Abstandshalter an.

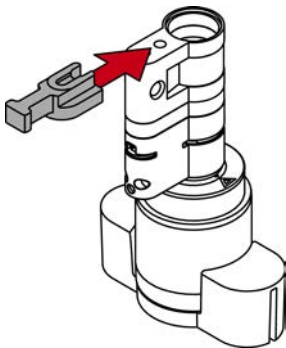

10. Schrauben Sie mit dem Ausheber einen passenden Bolzen ein, bis er am Abstandshalter anliegt.

**HINWEIS****Länge auf Bolzenkopf**

Sie finden auf dem Bolzenkopf eine Zahl. Diese Zahl ist die Länge des Zylinderprofils, zu dem der Bolzen passt.

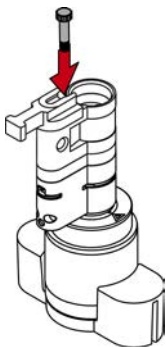

11. Setzen Sie die beiden Zylinderhälften wieder zusammen.

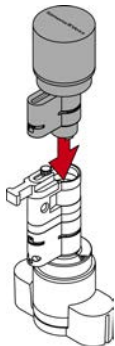

↳ Bolzen ist gegen Verdrehen geschützt.

12. Ziehen Sie den Abstandshalter wieder ab.

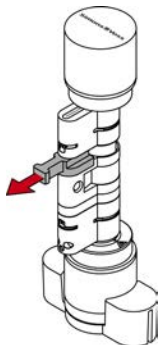

13. Schieben Sie die Hälften vollständig zusammen.

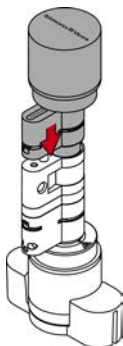

14. Setzen Sie die Klammer mit der Nase zur Stulpschraube wieder in den Schlitz des Profilzylinders ein.



15. Setzen Sie den Zylinder in den Klemmblock ein, so dass der Profilzylinder und der Knauf bündig in den Aussparungen liegen.

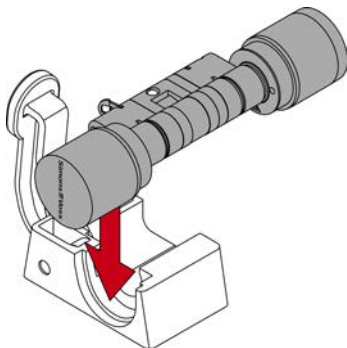

- ↳ Der Hebel des Klemmblocks ist an einer Stelle mit einem Metallplättchen verstärkt. Die vorhin eingeschobene Klammer liegt gegenüber dieses Metallplättchens.

16. Drücken Sie den Hebel des Klemmblocks zur Bodenplatte, bis die Klammer wieder vollständig im Profilylinder sitzt.

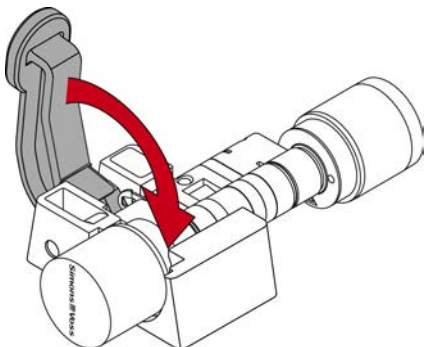

↳ Zylinder AX ist verkürzt.

6 CO-Zylinder zu FD kombinieren

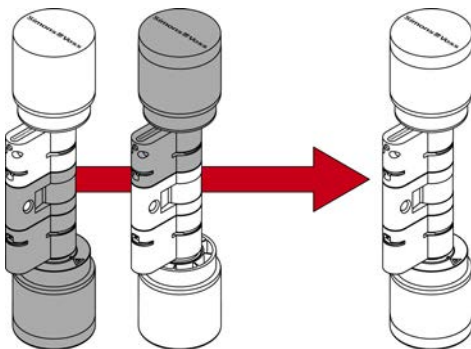

Aus zwei AX-Comfortzylindern können Sie einen freidrehenden Cylinder AX zusammensetzen.

- ✓ Ausheber zum Lösen der Klammer
 - ✓ Abstandshalter zum Ausrichten des Verlängerungsbolzens
 - ✓ Klemmblock zum Einpressen der Klammer
1. Stellen Sie den ersten Comfortzylinder AX mit dem mechanischen Knauf nach oben in das Knauf-Montagewerkzeug.

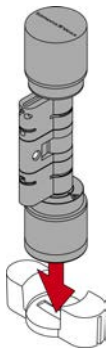

2. Haken Sie die Spitze des Aushebers in die Klammer ein.

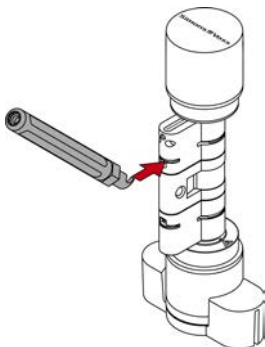

3. Hebeln Sie die Klammer aus dem Profilzylinder, indem Sie den Ausheber in die Mitte des Zylinders bewegen.

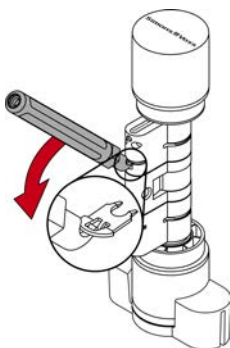

4. Ziehen Sie die Klammer vollständig aus dem Profilzylinder.



5. Nehmen Sie die beiden Zylinderhälften auseinander.

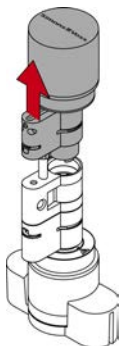

- ↳ Erste Zylinderhälfte mit Mittelstück und Mitnehmerbart vorbereitet.

6. Stellen Sie den zweiten Comfortzylinder AX mit dem elektronischen Knauf nach oben in das Knauf-Montagewerkzeug.

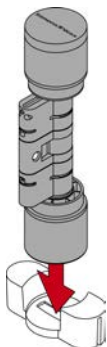

7. Haken Sie die Spitze des Aushebers in die Klammer ein.

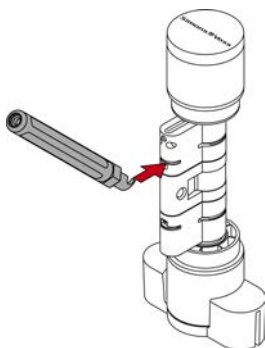

8. Hebeln Sie die Klammer aus dem Profilzylinder, indem Sie den Ausheber in die Mitte des Zylinders bewegen.

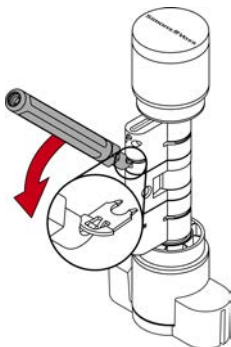

9. Ziehen Sie die Klammer vollständig aus dem Profilzylinder.



10. Nehmen Sie die beiden Zylinderhälften auseinander.

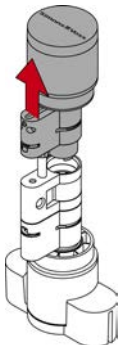

↳ Zweite Zylinderhälfte ohne Mittelstück vorbereitet.

11. Setzen Sie die erste Zylinderhälfte auf die zweite Zylinderhälfte.

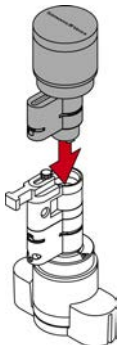

12. Setzen Sie die Klammer mit der Nase zur Stulpschraube wieder in den Schlitz des Profilzylinders ein.

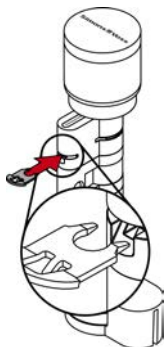

13. Setzen Sie den Zylinder in den Klemmblock ein, so dass der Profilzylinder und der Knauf bündig in den Aussparungen liegen.

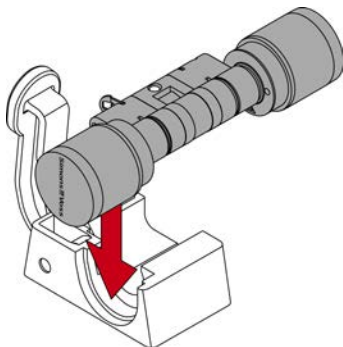

- ↳ Der Hebel des Klemmblocks ist an einer Stelle mit einem Metallplättchen verstärkt. Die vorhin eingeschobene Klammer liegt gegenüber dieses Metallplättchens.

14. Drücken Sie den Hebel des Klemmblocks zur Bodenplatte, bis die Klammer wieder vollständig im Profilzylinder sitzt.

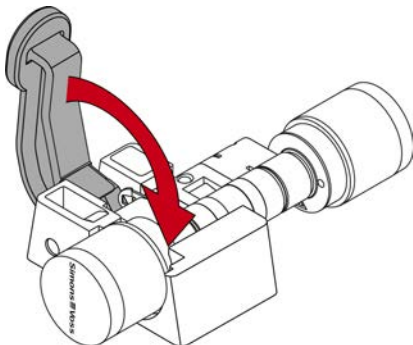

- ↳ Freidrehender Zylinder fertig zusammengesetzt.

**HINWEIS****Freidrehende aktive/hybride Digital Cylinder AX nur mit verkürzter Reichweite**

Bei freidrehenden Zylindern können die Leseknäufe bei geringen Zylinderlängen nicht genügend Abstand aufweisen. Durch die Reichweite der Aktiv-Technologie kann das Funksignal unbeabsichtigt auch durch den zweiten Leseknauf empfangen werden.

1. Programmieren Sie freidrehende Zylinder mit dem SmartStick AX oder dem SmartCD.MP.
2. Stellen Sie sicher, dass bei der Programmierung die verkürzte Reichweite ausgewählt ist (bei werkseitig als freidrehend gelieferten Zylindern standardmäßig eingestellt).

7 CO-Zylinder zu HZ reduzieren

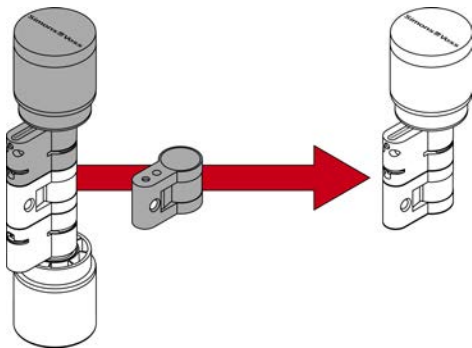

Aus einem AX-Comfortzylinder oder einem freidrehenden Zylinder können Sie mit einem speziellen Mittelstück einen Halbzylinder zusammensetzen.

- ✓ Ausheber zum Lösen der Klammer
- ✓ Abstandshalter zum Ausrichten des Verlängerungsbolzens
- ✓ Klemmblock zum Einpressen der Klammer
- ✓ Halbzylinder-Mittelstück

1. Stellen Sie den Cylinder AX mit dem elektronischen Knauf nach oben in das Knauf-Montagewerkzeug.

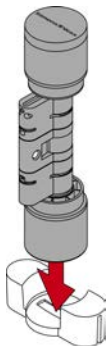

2. Haken Sie die Spitze des Aushebers in die Klammer ein.

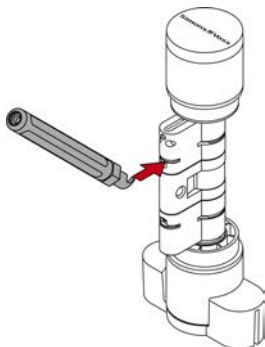

3. Hebeln Sie die Klammer aus dem Profilzylinder, indem Sie den Ausheber in die Mitte des Zylinders bewegen.

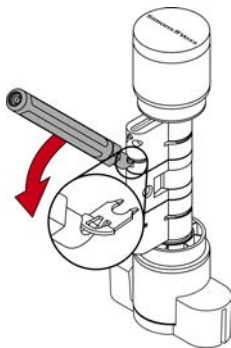

4. Ziehen Sie die Klammer vollständig aus dem Profilzylinder.
5. Nehmen Sie die beiden Zylinderhälften auseinander.

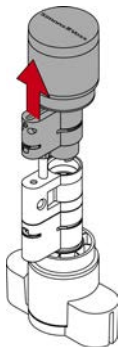

↳ Erste Zylinderhälfte ohne Mittelstück vorbereitet.

6. Legen Sie den Abstandshalter an das Halbzylinder-Mittelstück an.

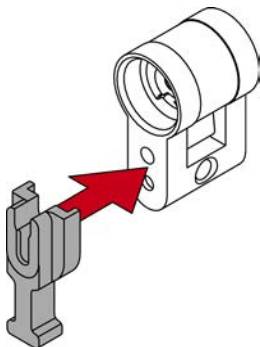

7. Schrauben Sie mit dem Ausheber einen passenden Verlängerungsbolzen ein, bis er am Abstandshalter anliegt.

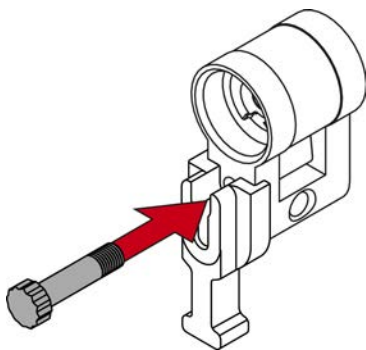

8. Stellen Sie die vorbereitete Zylinderhälfte in das Knauf-Montagewerkzeug.

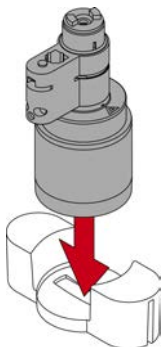

9. Setzen Sie das Halbzyylinder-Mittelstück auf die vorbereitete Zylinderhälfte.

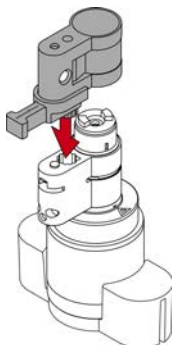

- ↳ Verlängerungsbolzen ist gegen Verdrehen geschützt.

10. Ziehen Sie den Abstandshalter wieder ab.

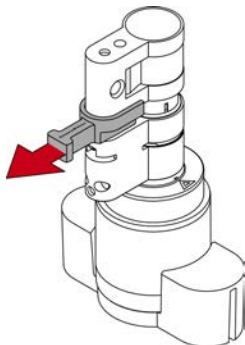

11. Schieben Sie die Zylinderteile vollständig zusammen.

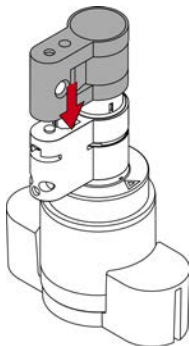

12. Setzen Sie die Klammer mit der Nase zur Stulpschraube wieder in den Schlitz des Profilzylinders ein.

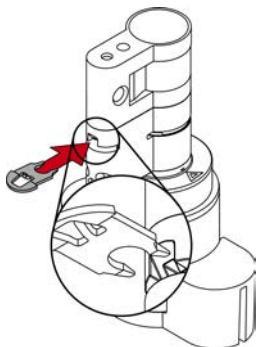

13. Setzen Sie den Zylinder in den Klemmblock ein, so dass der Profilzylinder und der Knauf bündig in den Aussparungen liegen.

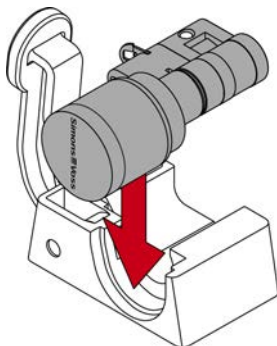

- ↳ Der Hebel des Klemmblocks ist an einer Stelle mit einem Metallplättchen verstärkt. Die vorhin eingeschobene Klammer liegt gegenüber dieses Metallplättchens.

14. Drücken Sie den Hebel des Klemmblocks zur Bodenplatte, bis die Klammer wieder vollständig im Profilzylinder sitzt.

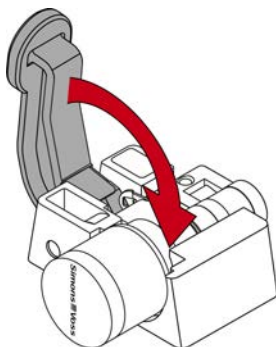

- ↳ Halbzylinder AX ist fertig zusammengesetzt.

8 Hilfe und weitere Informationen

Infomaterial/
Dokumente

<https://www.simons-voss.com/de/dokumente.html>

<https://www.smartintego.com/de/home/infocenter/dokumentation>

Konformitäts-
erklärungen
und Zertifika-
te

<https://www.simons-voss.com/de/zertifikate.html>

Technischer Support +49 (0) 89 / 99 228 333

E-Mail support-simonsvoss@allegion.com

si-support-simonsvoss@allegion.com

FAQ <https://faq.simons-voss.com/otrs/public.pl>

SimonsVoss Technologies GmbH, Feringastr. 4,
D-85774 Unterfoehring, Deutschland

Contents

1	General safety instructions.....	47
2	Product-specific safety instructions	48
3	Accessories and tools.....	49
4	Extend Cylinder AX.....	51
5	Shorten Cylinder AX.....	60
6	Combine CO cylinders to FD.....	69
7	Reduce CO cylinders to HZ.....	78
8	Help and other information	85

1 General safety instructions

Signal words
(ANSI
Z535.6)

DANGER: Death or serious injury (likely), WARNING: Death or serious injury (possible, but unlikely), CAUTION: Minor injury, IMPORTANT: Property damage or malfunction, NOTE: Low or no damage



WARNING

Blocked access

Access through a door may stay blocked due to incorrectly fitted and/or incorrectly programmed components. SimonsVoss Technologies GmbH is not liable for the consequences of blocked access such as access to injured or endangered persons, material damage or other damage!

Blocked access through manipulation of the product

If you change the product on your own, malfunctions can occur and access through a door can be blocked.

- Modify the product only when needed and only in the manner described in the documentation.

IMPORTANT

Damage resulting from liquids

This product contains electronic and/or mechanic components that may be damaged by liquids of any kind.

- Keep liquids away from the electronics.

Damage resulting from aggressive cleaning agents

The surface of this product may be damaged as a result of the use of unsuitable cleaning agents.

- Only use cleaning agents that are suitable for plastic or metal surfaces.

**NOTE****Intended use**

SimonsVoss-products are designed exclusively for opening and closing doors and similar objects.

- ❑ Do not use SimonsVoss products for any other purposes.

Qualifications required

The installation and commissioning requires specialized knowledge.

- ❑ Only trained personnel may install and commission the product.

Modifications or further technical developments cannot be excluded and may be implemented without notice.

The German language version is the original instruction manual. Other languages (drafting in the contract language) are translations of the original instructions.

Read and follow all installation, installation, and commissioning instructions. Pass these instructions and any maintenance instructions to the user.

2 Product-specific safety instructions

**WARNING****Malfunction of the anti-panic function due to unauthorised manipulation**

The length of the Digital Cylinder AX can be modified on the inside from 50 mm. If the AP side is removed, the anti-panic unit may be damaged.

- ❑ Do not change the length on the AP side.

3 Accessories and tools

The profile cylinder can be extended and shortened with the following parts:

Extension bolt	Core extension for the profile	Profile extension
 <ul style="list-style-type: none"> ■ Z5.BOLT.XX (XX = required basic length) 	 <ul style="list-style-type: none"> ■ Z5.CORE.05: 5 mm ■ Z5.CORE.10: 10 mm ■ Z5.CORE.20: 20 mm 	 <ul style="list-style-type: none"> ■ Z5.PROFILE.05: 5 mm ■ Z5.PROFILE.10: 10 mm ■ Z5.PROFILE.20: 20 mm
Clamps	Half cylinder centre piece	Cylinder centre piece
 <ul style="list-style-type: none"> ■ Z5.CLAMPS <p>Set contains 50 units.</p>	 <ul style="list-style-type: none"> ■ Z5.CNT.HZ 	 <ul style="list-style-type: none"> ■ Z5.CNT.EU

Cam (standard, WP)	Inside thumb-turn mount
 <p data-bbox="55 406 248 436">■ Z5.CAM.WP</p>	 <p data-bbox="348 406 497 436">■ Z5.PR.IN</p>

To do this, you need the following tools:

Extractor (Z5.LIFTER)	SPACER (Z5.SPACER)	Terminal BLOCK (Z5.BLOCK)
		

The Cylinder AX thumb-turn assembly tool is designed so that you can use it as a bracket for the Cylinder AX. Place it with the flat side on a flat surface and place the Cylinder AX with the knob in the assembly tool. Reassembly is easier if the AX cylinder is in the bracket.

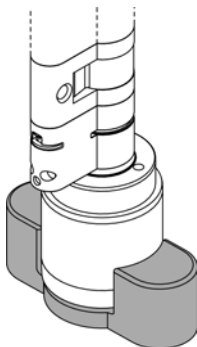

4 Extend Cylinder AX

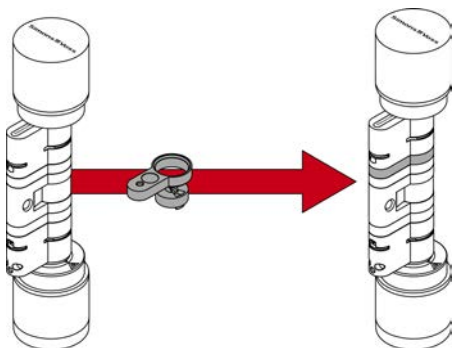

The core extension and profile extension must be the same length. You also need an extension bolt for the desired length.

- ✓ Extractor for releasing the clamp

- ✓ Spacer for aligning the extension bolt
- ✓ Clamp block for pressing in the clamp

1. Place the Cylinder AX in the thumb-turn assembly tool.



2. Hook the tip of the extractor into the clamp.

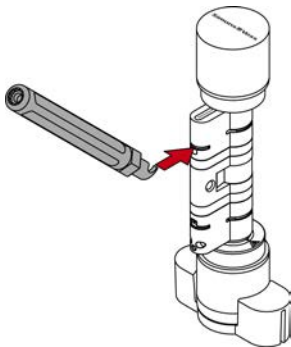

3. Lever the clamp out of the profile cylinder by moving the extractor to the centre of the cylinder.

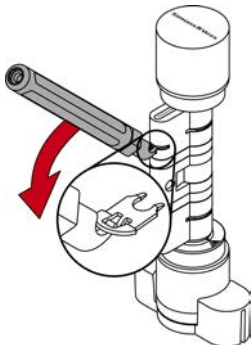

4. Pull the clamp completely out of the profile cylinder.

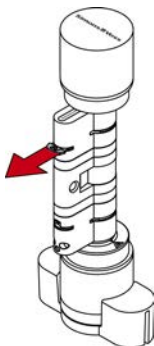

5. Disassemble the two cylinder halves.

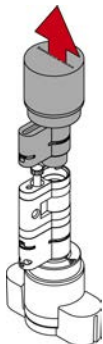

6. Use the extractor to unscrew the extension bolt.

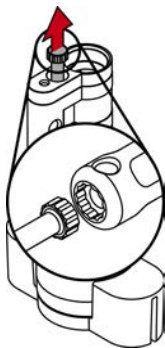

7. Insert suitable core extensions.

8. Attach suitable profile extensions.



9. Place the spacer.

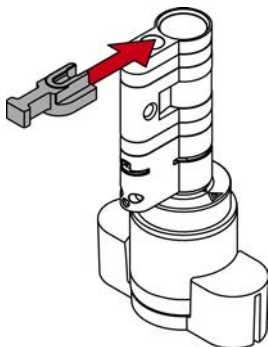

10. Screw in a suitable extension bolt with the extractor until it rests on the spacer.

**NOTE****Length on bolt head**

You will find a number on the bolt head. This number is the length of the cylinder profile to which the bolt fits.

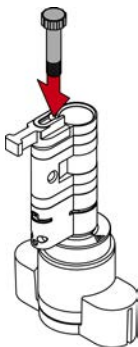

11. Reassemble the two cylinder halves.

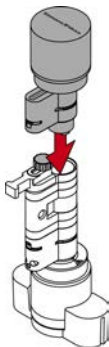

- ↳ Extension bolt is protected against twisting.
12. Pull the spacer off again.

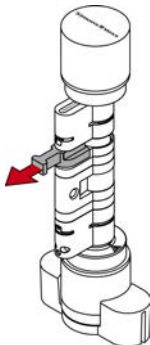

13. Push the halves together completely.

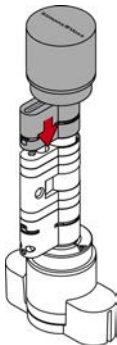

14. Place the clip back into the slot of the profile cylinder with its lug facing the fastening screw and press the clamp with your thumb so that it can no longer fall out.

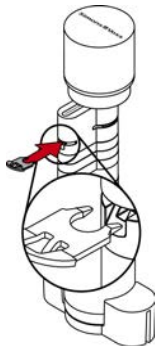

15. Insert the cylinder into the clamping block so that the profile cylinder and the thumb-turn lie flush in the recesses.

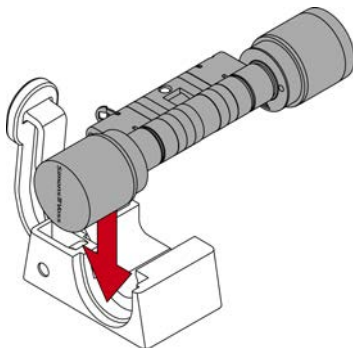

- ↳ The lever of the clamping block is reinforced at one point with a metal plate. The bracket that was previously inserted lies opposite this metal plate.
16. Push the clamp block lever towards the base plate until the clamp is fully seated in the profile cylinder.

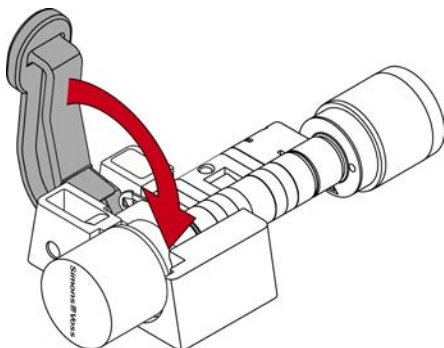

↳ Cylinder AX is extended.

5 Shorten Cylinder AX

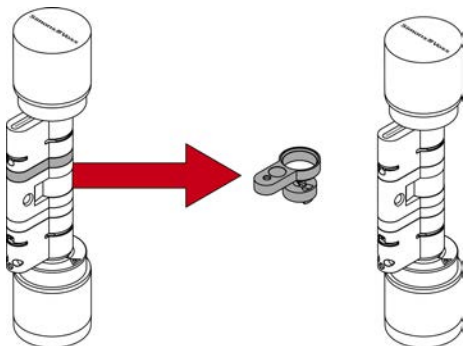

You need a bolt for the desired length.

- ✓ Extractor for releasing the clamp
- ✓ Spacer for aligning the bolt

- ✓ Clamp block for pressing in the clamp
1. Place the Cylinder AX in the thumb-turn assembly tool.



2. Hook the tip of the extractor into the clamp.

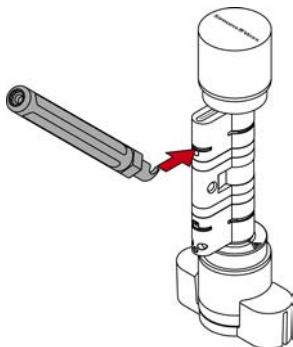

3. Lever the clamp out of the profile cylinder by moving the extractor to the centre of the cylinder.

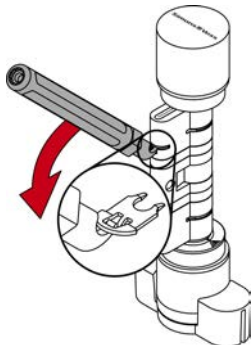

4. Pull the clamp completely out of the profile cylinder.

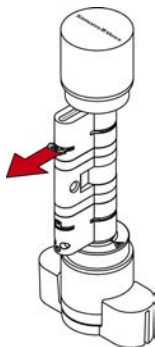

5. Disassemble the two cylinder halves.

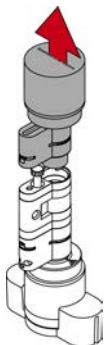

6. Unscrew the bolt with the extractor.

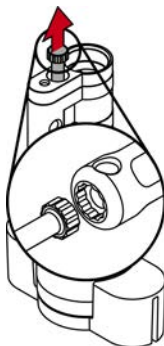

7. Remove the profile extension.

8. Remove the core extension.



9. Place the spacer.

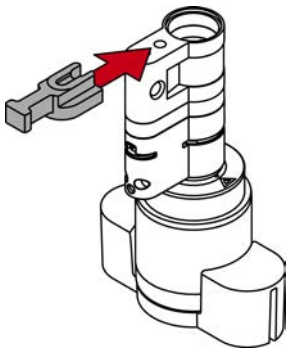

10. Screw in a suitable bolt with the extractor until it rests on the spacer.

**NOTE****Length on bolt head**

You will find a number on the bolt head. This number is the length of the cylinder profile to which the bolt fits.

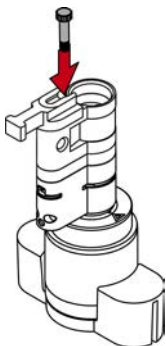

11. Reassemble the two cylinder halves.

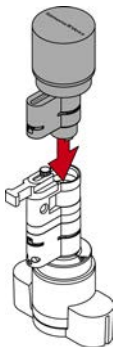

↳ Bolt is protected against twisting.

12. Pull the spacer off again.

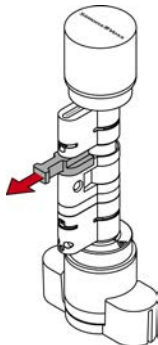

13. Push the halves together completely.

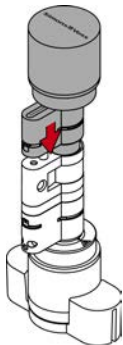

14. Refit the clip into the slot of the profile cylinder with the lug facing the fastening screw.

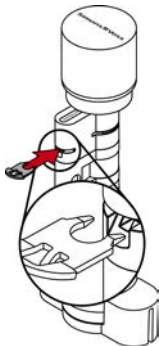

15. Insert the cylinder into the clamping block so that the profile cylinder and the thumb-turn lie flush in the recesses.

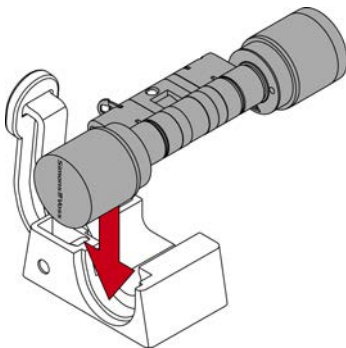

- ↳ The lever of the clamping block is reinforced at one point with a metal plate. The bracket that was previously inserted lies opposite this metal plate.

16. Push the clamp block lever towards the base plate until the clamp is fully seated in the profile cylinder.

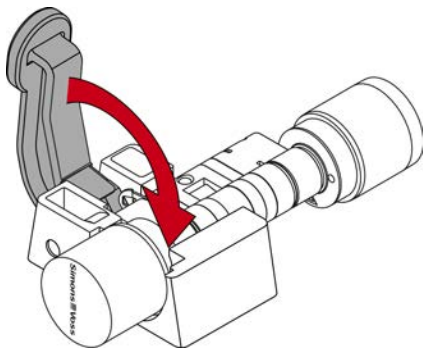

- ↳ Cylinder AX is shortened.

6 Combine CO cylinders to FD

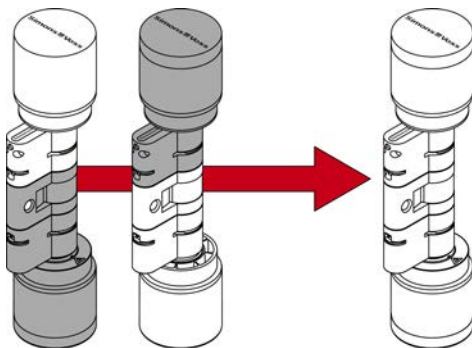

You can assemble a freely rotating AX cylinder from two AX comfort cylinders.

- ✓ Extractor for releasing the clamp
- ✓ Spacer for aligning the extension bolt
- ✓ Clamp block for pressing in the clamp

1. Place the first comfort cylinder AX in the thumb-turn assembly tool with the mechanical thumb-turn facing upwards.

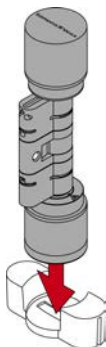

2. Hook the tip of the extractor into the clamp.

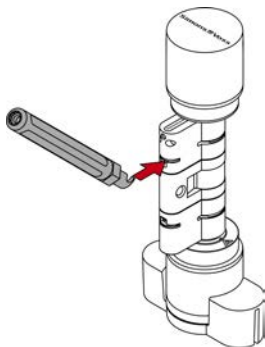

3. Lever the clamp out of the profile cylinder by moving the extractor to the centre of the cylinder.

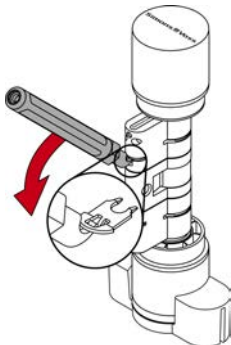

4. Pull the clamp completely out of the profile cylinder.



5. Disassemble the two cylinder halves.

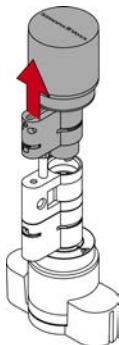

- ↳ First cylinder half prepared with centre piece and tappet piece.

6. Place the second comfort cylinder AX in the thumb-turn assembly tool with the electronic thumb-turn facing upwards.

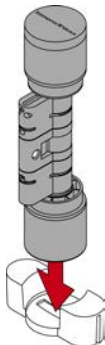

- Hook the tip of the extractor into the clamp.

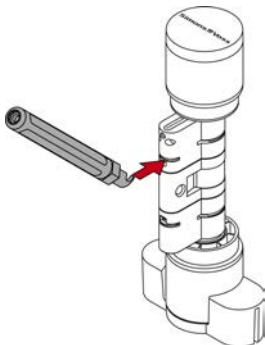

- Lever the clamp out of the profile cylinder by moving the extractor to the centre of the cylinder.

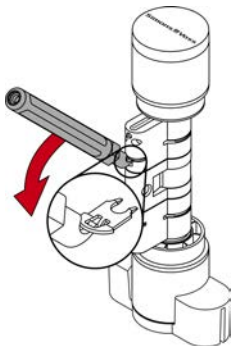

9. Pull the clamp completely out of the profile cylinder.



10. Disassemble the two cylinder halves.

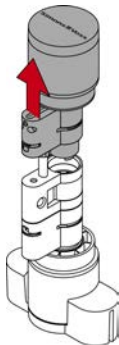

- ↳ Second cylinder half prepared without centre piece.

11. Place the first cylinder half on the second cylinder half.

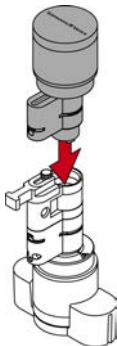

12. Refit the clip into the slot of the profile cylinder with the lug facing the fastening screw.



13. Insert the cylinder into the clamping block so that the profile cylinder and the thumb-turn lie flush in the recesses.

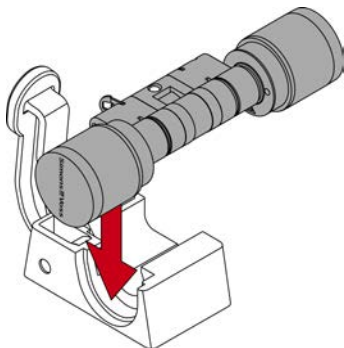

- ↳ The lever of the clamping block is reinforced at one point with a metal plate. The bracket that was previously inserted lies opposite this metal plate.

14. Push the clamp block lever towards the base plate until the clamp is fully seated in the profile cylinder.

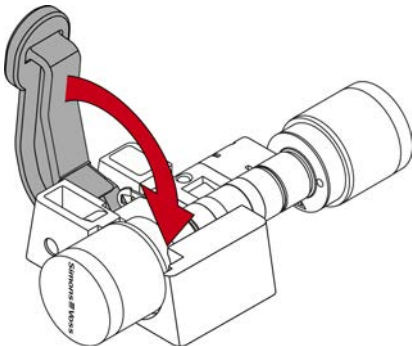

- ↳ Freely rotating cylinder fully assembled.



NOTE

Freely rotating active/hybrid Digital Cylinder AX only with shortened range

With freely rotating cylinders, the reader knobs may not have sufficient clearance at low cylinder lengths. Due to the range of the active technology, the radio signal can also be unintentionally received by the second reader knob.

1. Program freely rotating cylinders with the SmartStick AX or the SmartCD.MP.
2. Ensure that the short range is selected during programming (standard setting for cylinders factory-supplied as freely rotating).

7 Reduce CO cylinders to HZ

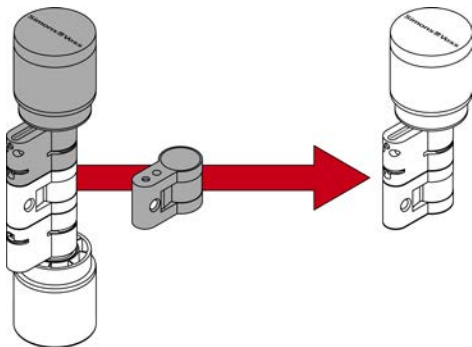

You can use a special centre piece to assemble a half cylinder from an AX comfort cylinder or a freely rotating cylinder.

- ✓ Extractor for releasing the clamp
- ✓ Spacer for aligning the extension bolt
- ✓ Clamp block for pressing in the clamp
- ✓ Half Cylinder Center Section

1. Place the Cylinder AX in the thumb-turn assembly tool with the electronic thumb-turn facing upwards.

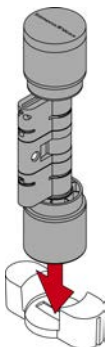

2. Hook the tip of the extractor into the clamp.

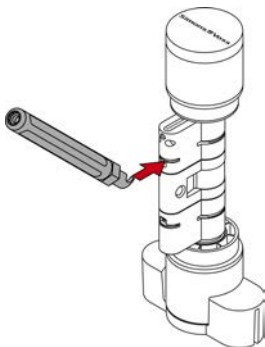

3. Lever the clamp out of the profile cylinder by moving the extractor to the centre of the cylinder.

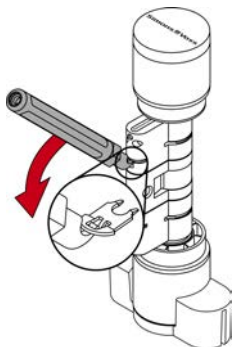

4. Pull the clamp completely out of the profile cylinder.
5. Disassemble the two cylinder halves.

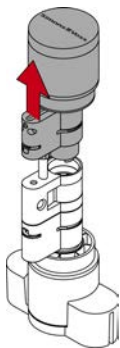

↳ First cylinder half prepared without centre piece.

6. Place the spacer on the half-cylinder centre piece.

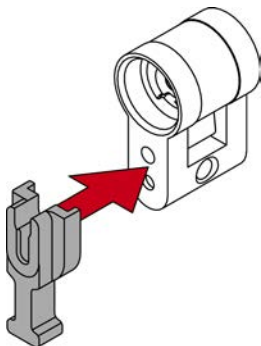

7. Screw in a suitable extension bolt with the extractor until it rests on the spacer.

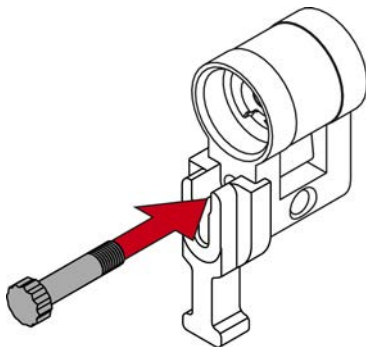

8. Place the prepared cylinder half in the thumb-turn assembly tool.

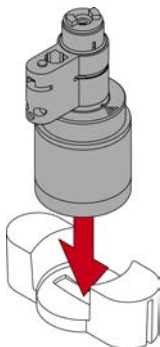

9. Place the half cylinder centre piece on the prepared cylinder half.



↳ Extension bolt is protected against twisting.

10. Pull the spacer off again.

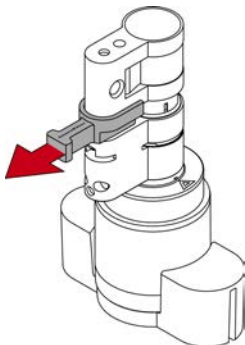

11. Push the cylinder parts together completely.

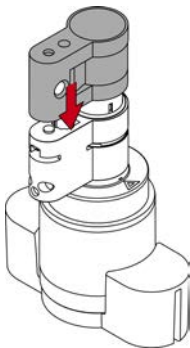

12. Refit the clip into the slot of the profile cylinder with the lug facing the fastening screw.

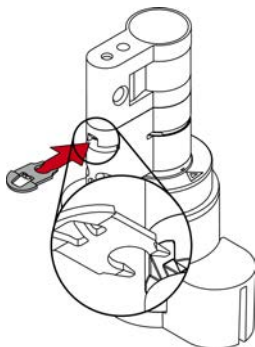

13. Insert the cylinder into the clamping block so that the profile cylinder and the thumb-turn lie flush in the recesses.

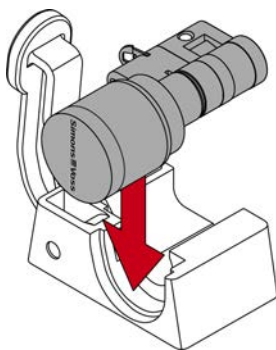

- ↳ The lever of the clamping block is reinforced at one point with a metal plate. The bracket that was previously inserted lies opposite this metal plate.

14. Push the clamp block lever towards the base plate until the clamp is fully seated in the profile cylinder.

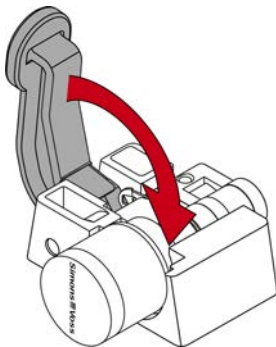

- ↳ Half cylinder AX is fully assembled.

8 Help and other information

Information material/documents

<https://www.simons-voss.com/en/documents.html>

<https://www.smartintego.com/int/home/infocenter/documentation>

Declarations of conformity

<https://www.simons-voss.com/en/certificates.html>

Technical support

+49 (0) 89 / 99 228 333

Email

support-simonsvoss@allegion.com

si-support-simonsvoss@allegion.com

FAQs

<https://faq.simons-voss.com/otrs/public.pl>

SimonsVoss Technologies GmbH, Feringastr. 4,
D-85774 Unterfoehring, Germany

Tables des matières

1	Consignes de sécurité générales	88
2	Consignes de sécurité propres au produit	90
3	Accessoires et outils	90
4	Extension du cylindre AX	92
5	Raccourcissement du cylindre AX	102
6	Combinaison de cylindres CO en un FD	112
7	Réduction d'un cylindre CO en un HZ	121
8	Aide et autres informations	129

1 Consignes de sécurité générales

Mots indicateurs (ANSI Z535.6)

DANGER: Mort ou blessure grave (probable), AVERTISSEMENT: Mort ou blessure grave (possible, mais improbable), ATTENTION: Blessure légère, ATTENTION: Dommages matériels ou dysfonctionnements, REMARQUE: Peu ou pas de dommage



AVERTISSEMENT

Accès bloqué

Toute erreur de montage et/ou de programmation d'un composant peut bloquer l'accès par une porte. La société SimonsVoss Technologies GmbH décline toute responsabilité quant aux conséquences d'un accès bloqué, par exemple, accès pour les personnes blessées ou en danger, dommages matériels ou autres dommages !

Accès bloqué par la manipulation du produit

Si vous modifiez vous-même le produit, des dysfonctionnements peuvent se produire et l'accès peut être bloqué par une porte.

- Ne changez le produit que lorsque cela est nécessaire et de la manière décrite dans la documentation.

ATTENTION

Endommagement lié à des liquides

Ce produit contient des composants électroniques et/ou mécaniques susceptibles d'être endommagés par tout type de liquide.

- Tenez les liquides à l'écart du système électronique.

Endommagement lié à des nettoyeurs agressifs

La surface de ce produit peut être endommagée par des nettoyeurs inappropriés.

- Utilisez exclusivement des nettoyeurs adaptés aux surfaces plastiques ou métalliques.



REMARQUE

Utilisation conforme aux dispositions

Les produits SimonsVoss sont exclusivement destinés à l'ouverture et la fermeture de portes et d'objets similaires.

- N'utilisez pas les produits SimonsVoss à d'autres fins.

Qualifications requises

L'installation et la mise en service nécessitent des connaissances spécialisées.

- Seul le personnel qualifié peut installer et mettre en service le produit.

Les modifications et nouveaux développements techniques ne peuvent pas être exclus et peuvent être mis en œuvre sans préavis.

La version allemande est le manuel d'instruction original. Les autres langues (rédaction dans la langue du contrat) sont des traductions des instructions originales.

Lisez et suivez toutes les instructions d'installation, d'installation et de mise en service. Transmettez ces instructions et toutes les instructions de maintenance à l'utilisateur.

2 Consignes de sécurité propres au produit



AVERTISSEMENT

Dysfonctionnement de la fonction antipanique du fait d'une mauvaise manipulation





La longueur du Digital Cylinder AX peut être modifiée à l'intérieur à partir de 50 mm. Si le côté AP est démonté, l'unité antipanique risque d'être endommagée.

- Ne modifiez pas la longueur côté AP.

3 Accessoires et outils

Le cylindre profilé peut être allongé et raccourci à l'aide des pièces suivantes :

Tige d'extension	Extension de base du profil	Extension de profil
 ■ Z5.BOLT.XX (XX=longueur de base souhaitée)	 ■ Z5.CORE.05 : 5 mm ■ Z5.CORE.10 : 10 mm ■ Z5.CORE.20 : 20 mm	 ■ Z5.PROFILE.05 : 5 mm ■ Z5.PROFILE.10 : 10 mm ■ Z5.PROFILE.20 : 20 mm

Clips	Pièce centrale du demi-cylindre	Pièce centrale du cylindre
 <p>■ Z5.CLAMPS Un kit comprend 50 pièces.</p>	 <p>■ Z5.CNT.HZ</p>	 <p>■ Z5.CNT.EU</p>
Panneton (standard, WP)		Logement du bouton intérieur
 <p>■ Z5.CAM.WP</p>	 <p>■ Z5.PR.IN</p>	

À cet effet, vous avez besoin des outils suivants :

Clé de levage (Z5.LIF-TER)	Cale (Z5.SPACER)	Bloc de serrage (Z5.BLOCK)
		

L'outil de montage de poignée du cylindre AX est conçu de manière à pouvoir être utilisé comme support pour le cylindre AX. Posez-le avec le côté plat

sur une surface plane et placez le cylindre AX avec le bouton dans l'outil de montage. Le remontage est plus facile si le cylindre AX se trouve dans le support.

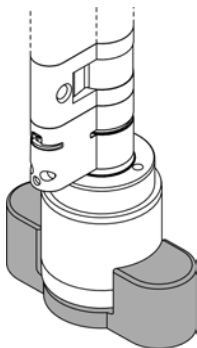

4 Extension du cylindre AX

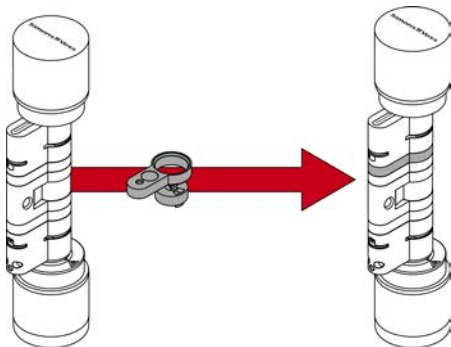

L'extension de base et l'extension de profil doivent avoir les mêmes longueurs. En outre, vous avez besoin d'une tige d'extension de la longueur souhaitée.

- ✓ Clé de levage pour desserrer le clip
- ✓ Cale pour aligner la tige d'extension
- ✓ Bloc de serrage pour poser le clip

1. Placez le cylindre AX dans l'outil de montage de poignée.



2. Accrochez la pointe de la clé de levage dans le clip.

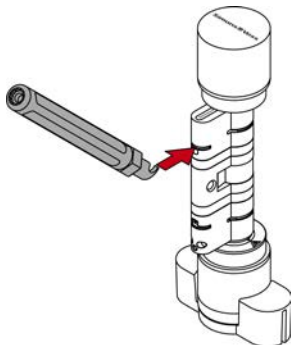

3. Faites lever pour séparer le clip du cylindre profilé en déplaçant le dispositif de levage au milieu du cylindre.

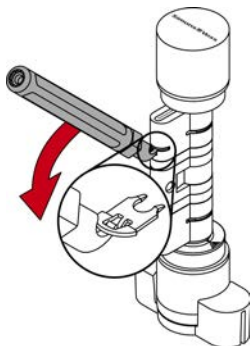

4. Retirez entièrement le clip du cylindre profilé.

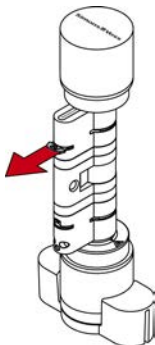

5. Démontez les deux moitiés du cylindre.

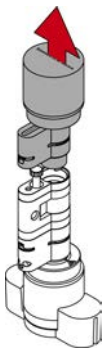

6. Dévissez la tige d'extension à l'aide de la clé de levage.

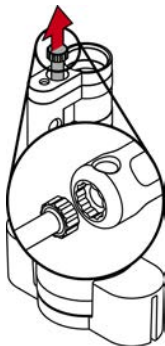

7. Insérez des extensions de base adaptées.
8. Mettez en place des extensions de profil adaptées.



9. Placez la cale.

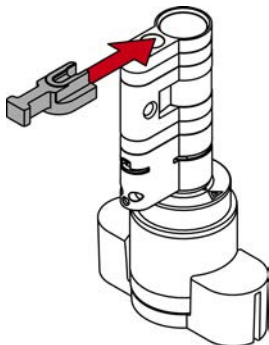

10. Vissez à l'aide de la clé de levage une tige d'extension adaptée jusqu'à ce qu'elle soit en contact avec la cale.



REMARQUE

Longueur sur la tête de boulon

Sur la tête de boulon, vous trouverez un nombre. Ce nombre correspond à la longueur du profil du cylindre pour lequel le boulon convient.

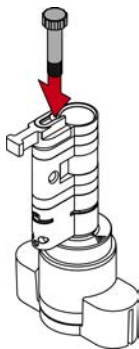

11. Remontez les deux moitiés du cylindre.

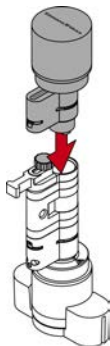

↳ La tige d'extension est protégée contre la torsion.

12. Retirez la cale.

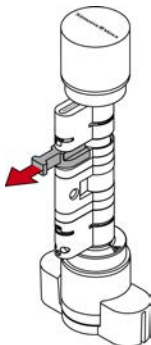

13. Rapprochez complètement les deux moitiés.

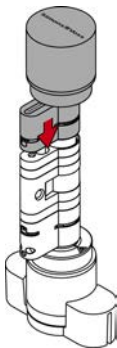

14. Remplacez le clip avec l'ergot en direction de la vis de maintien dans la fente du cylindre profilé et appuyez fermement sur le clip avec le pouce pour qu'il ne puisse plus tomber.

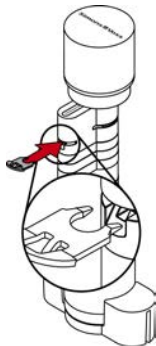

15. Placez le cylindre dans le bloc de serrage de manière à ce que le cylindre profilé et le bouton affleurent dans les évidements.

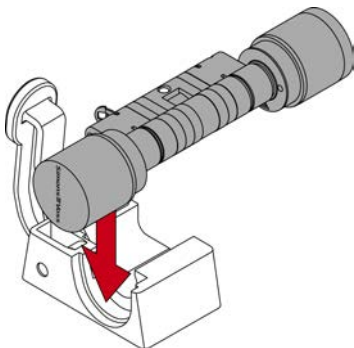

- ↳ Une partie du levier du bloc de serrage est renforcée par une petite plaque métallique. Le clip qui a été inséré se trouve en face de cette petite plaque métallique.
16. Poussez le levier du bloc de serrage vers la plaque de base jusqu'à ce que le clip soit entièrement enfoncé dans le cylindre profilé.

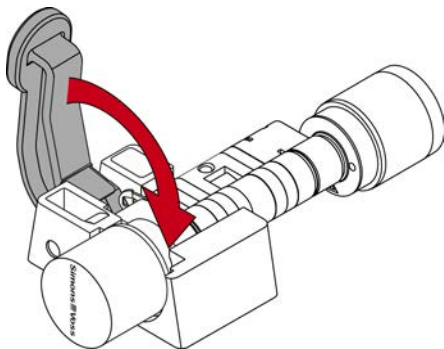

↳ Le cylindre AX est rallongé.

5 Raccourcissement du cylindre AX

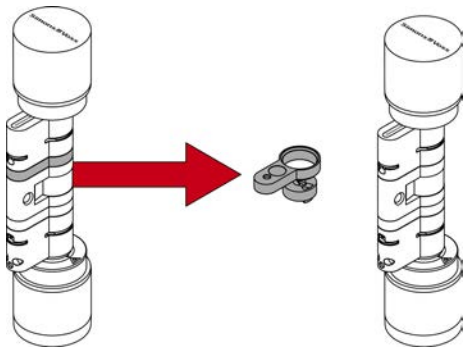

Vous avez besoin d'une tige d'extension de la longueur souhaitée.

✓ Clé de levage pour desserrer le clip

- ✓ Cale pour aligner la tige
 - ✓ Bloc de serrage pour poser le clip
1. Placez le cylindre AX dans l'outil de montage de poignée.



2. Accrochez la pointe de la clé de levage dans le clip.

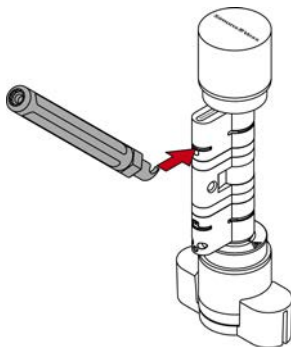

3. Faites levier pour séparer le clip du cylindre profilé en déplaçant le dispositif de levage au milieu du cylindre.

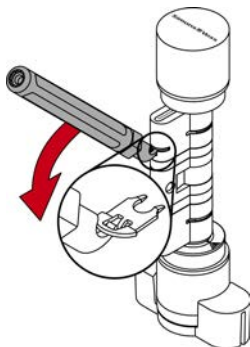

4. Retirez entièrement le clip du cylindre profilé.

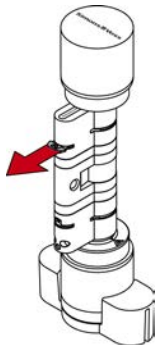

5. Démontez les deux moitiés du cylindre.

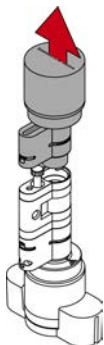

6. Dévissez la tige à l'aide de clé de levage.

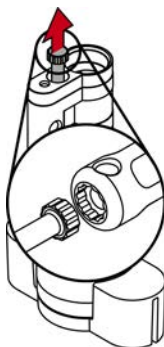

7. Retirez les extensions de profil.

8. Retirez les extensions de base.



9. Placez la cale.

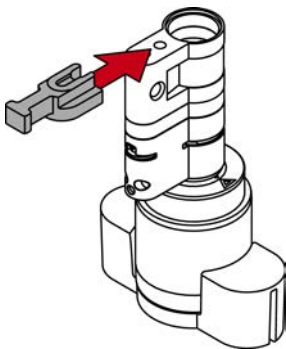

10. Vissez à l'aide de la clé de levage une tige adaptée jusqu'à ce qu'elle soit en contact avec la cale.

**REMARQUE****Longueur sur la tête de boulon**

Sur la tête de boulon, vous trouverez un nombre. Ce nombre correspond à la longueur du profil du cylindre pour lequel le boulon convient.

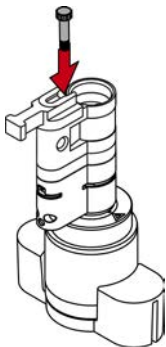

11. Remontez les deux moitiés du cylindre.

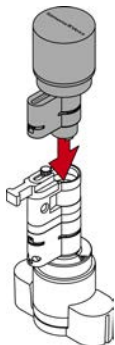

↳ La tige est protégée contre la torsion.

12. Retirez la cale.

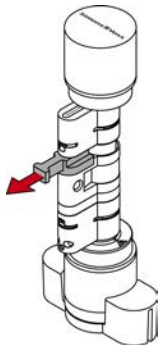

13. Rappechez complètement les deux moitiés.



14. Remplacez le clip avec l'ergot en direction de la vis de maintien dans la fente du cylindre profilé.



- Placez le cylindre dans le bloc de serrage de manière à ce que le cylindre profilé et le bouton affleurent dans les évidements.

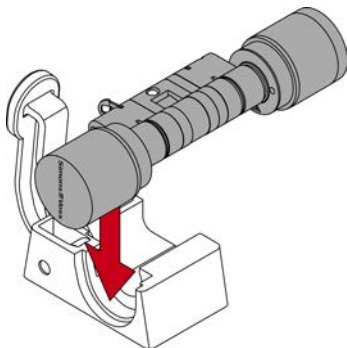

- ↳ Une partie du levier du bloc de serrage est renforcée par une petite plaque métallique. Le clip qui a été inséré se trouve en face de cette petite plaque métallique.

16. Poussez le levier du bloc de serrage vers la plaque de base jusqu'à ce que le clip soit entièrement enfoncé dans le cylindre profilé.

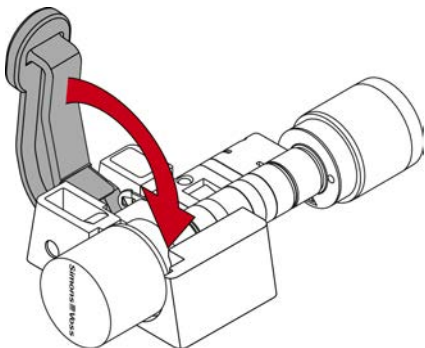

- ↳ Le cylindre AX est raccourci.

6 Combinaison de cylindres CO en un un FD

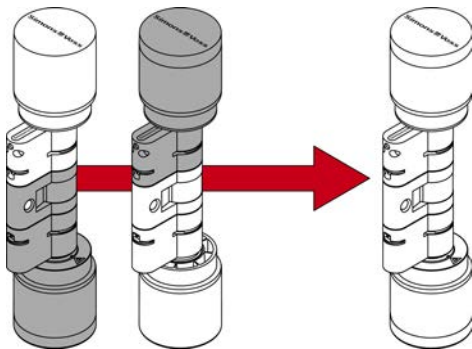

Vous pouvez assembler deux cylindres confort AX pour former un cylindre AX à rotation libre.

- ✓ Clé de levage pour desserrer le clip
- ✓ Cale pour aligner la tige d'extension
- ✓ Bloc de serrage pour poser le clip

1. Placez le premier cylindre confort AX avec le bouton mécanique vers le haut dans l'outil de montage de poignée.

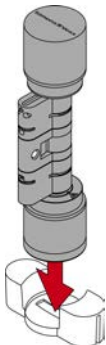

2. Accrochez la pointe de la clé de levage dans le clip.

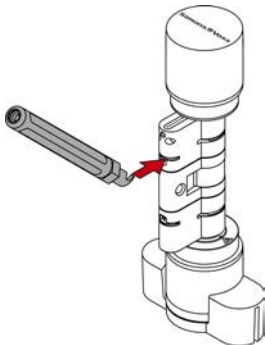

3. Faites levier pour séparer le clip du cylindre profilé en déplaçant le dispositif de levage au milieu du cylindre.

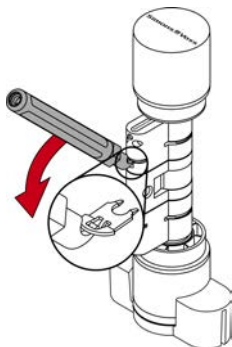

4. Retirez entièrement le clip du cylindre profilé.

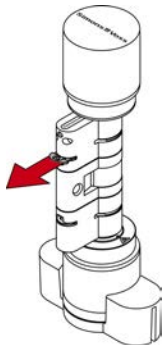

5. Démontez les deux moitiés du cylindre.

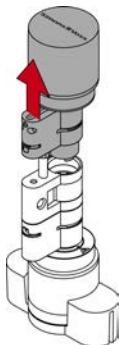

- ↳ La première moitié de cylindre est préparée avec pièce centrale et dispositif d'entraînement.

6. Placez le deuxième cylindre confort AX avec le bouton électronique vers le haut dans l'outil de montage de poignée.

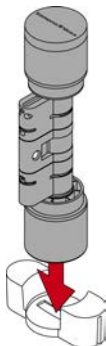

7. Accrochez la pointe de la clé de levage dans le clip.

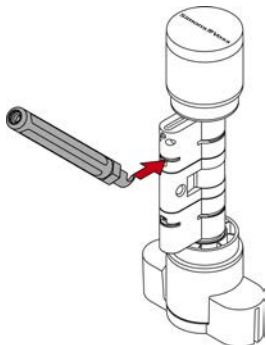

8. Faites lever pour séparer le clip du cylindre profilé en déplaçant le dispositif de levage au milieu du cylindre.

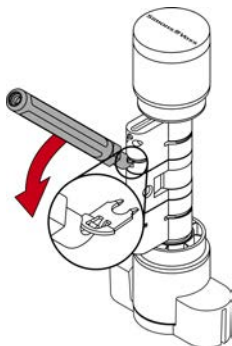

9. Retirez entièrement le clip du cylindre profilé.



10. Démontez les deux moitiés du cylindre.

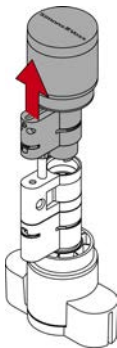

↳ La deuxième moitié de cylindre est préparée sans pièce centrale.

11. Placez la première moitié de cylindre sur la deuxième moitié de cylindre.

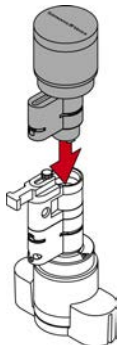

12. Remplacez le clip avec l'ergot en direction de la vis de maintien dans la fente du cylindre profilé.

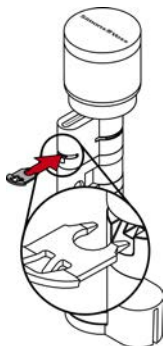

13. Placez le cylindre dans le bloc de serrage de manière à ce que le cylindre profilé et le bouton affleurent dans les évidements.

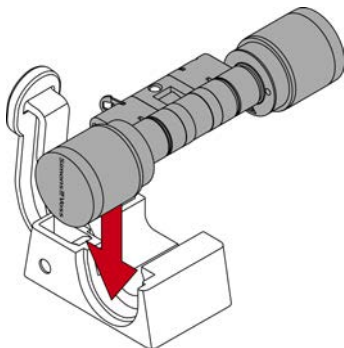

- ↳ Une partie du levier du bloc de serrage est renforcée par une petite plaque métallique. Le clip qui a été inséré se trouve en face de cette petite plaque métallique.

14. Poussez le levier du bloc de serrage vers la plaque de base jusqu'à ce que le clip soit entièrement enfoncé dans le cylindre profilé.

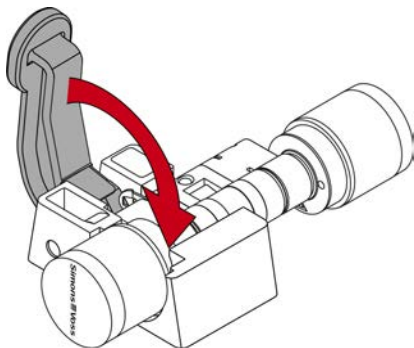

- ↳ L'assemblage du cylindre à rotation libre est terminé.



REMARQUE

Digital Cylinder AX actif/hybride à rotation libre avec portée réduite

Pour les cylindres à rotation libre, les boutons de lecture peuvent présenter une distance insuffisante en cas de cylindres courts. En raison de la portée de la technologie active, le signal radio peut être reçu involontairement par le deuxième bouton de lecture.

1. Programmez des cylindres à rotation libre avec le SmartStick AX ou le SmartCD.MP.
2. Veillez à sélectionner la portée réduite lors de la programmation (réglage par défaut en usine pour les cylindres à rotation libre)

7 Réduction d'un cylindre CO en un HZ

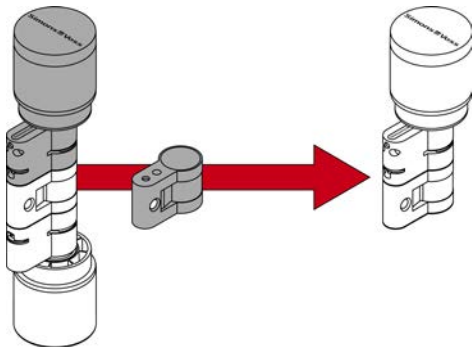

Vous pouvez assembler un demi-cylindre à partir d'un cylindre confort AX ou d'un cylindre à rotation libre à l'aide d'une pièce centrale.

- ✓ Clé de levage pour desserrer le clip
- ✓ Cale pour aligner la tige d'extension
- ✓ Bloc de serrage pour poser le clip
- ✓ Pièce centrale du demi-cylindre

1. Placez le cylindre AX avec le bouton électronique vers le haut dans l'outil de montage de poignée.

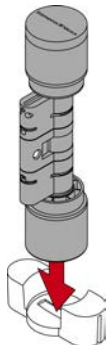

2. Accrochez la pointe de la clé de levage dans le clip.

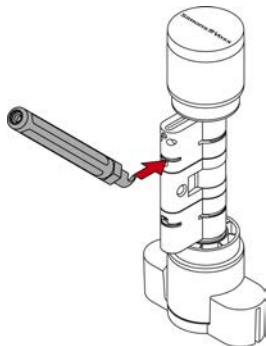

3. Faites levier pour séparer le clip du cylindre profilé en déplaçant le dispositif de levage au milieu du cylindre.

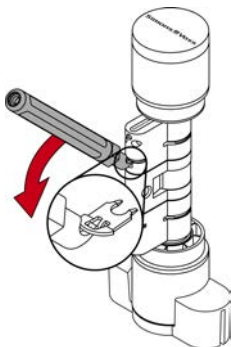

4. Retirez entièrement le clip du cylindre profilé.
5. Démontez les deux moitiés du cylindre.

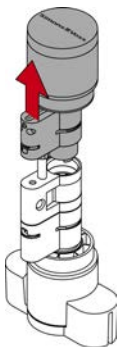

- ↳ La première moitié de cylindre est préparée sans pièce centrale.
6. Placez la cale sur la pièce centrale du demi-cylindre.

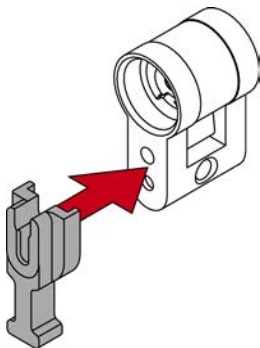

7. Vissez à l'aide de la clé de levage une tige d'extension adaptée jusqu'à ce qu'elle soit en contact avec la cale.

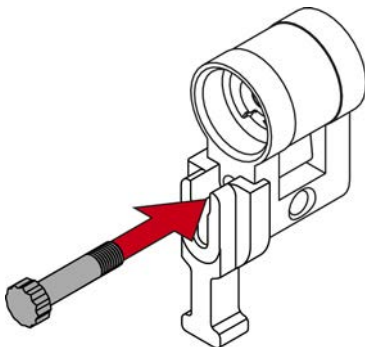

8. Placez la moitié de cylindre préparée dans l'outil de montage de poignée.

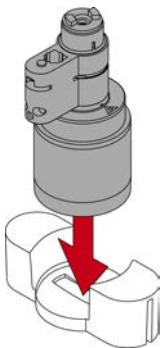

9. Placez la pièce centrale du demi-cylindre sur la moitié de cylindre préparée.

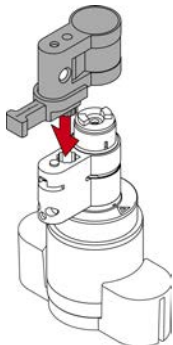

- ↳ La tige d'extension est protégée contre la torsion.

10. Retirez la cale.

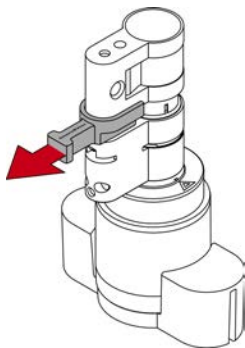

11. Rapprochez complètement les parties du cylindre.

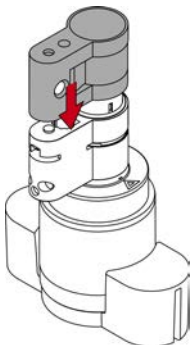

12. Replacez le clip avec l'ergot en direction de la vis de maintien dans la fente du cylindre profilé.

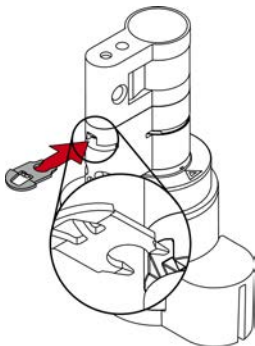

13. Placez le cylindre dans le bloc de serrage de manière à ce que le cylindre profilé et le bouton affleurent dans les évidements.

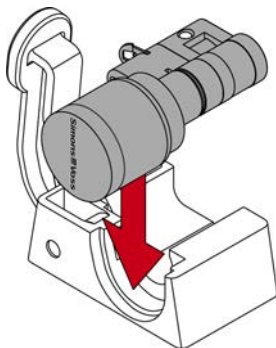

- ↳ Une partie du levier du bloc de serrage est renforcée par une petite plaque métallique. Le clip qui a été inséré se trouve en face de cette petite plaque métallique.

14. Poussez le levier du bloc de serrage vers la plaque de base jusqu'à ce que le clip soit entièrement enfoncé dans le cylindre profilé.

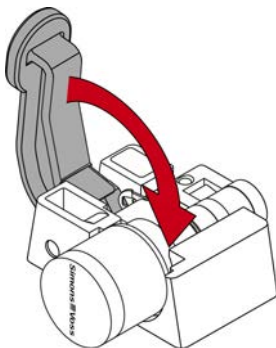

- ↳ L'assemblage du demi-cylindre AX est terminé.

8 Aide et autres informations

Documentation/ documents	https://www.simons-voss.com/fr/documents.html https://www.smartintego.com/fr/home/infocenter/ documentations
Déclarations de conformité	https://www.simons-voss.com/fr/certificats.html
Assistance technique	+49 (0) 89 / 99 228 333
E-Mail	support-simonsvoss@allegion.com si-support-simonsvoss@allegion.com
FAQ	https://faq.simons-voss.com/otrs/public.pl

SimonsVoss Technologies GmbH, Feringastr. 4,
D-85774 Unterfoehring, Allemagne



This is SimonsVoss

SimonsVoss, the pioneer in remote-controlled, cable-free locking technology provides system solutions with a wide range of products for SOHOs, SMEs, major companies and public institutions.

SimonsVoss locking systems combine intelligent functionality, high quality and award-winning design Made in Germany.

As an innovative system provider, SimonsVoss focuses on scalable systems, high security, reliable components, powerful software and simple operation. As such, SimonsVoss is regarded as a technology leader in digital locking systems. Our commercial success lies in the courage to innovate, sustainable thinking and action, and heartfelt appreciation of employees and partners.

SimonsVoss is a company in the ALLEGION Group, a globally active network in the security sector. Allegion is represented in around 130 countries worldwide (www.allegion.com).

Made in Germany

SimonsVoss is truly committed to Germany as a manufacturing location: all products are developed and produced exclusively in Germany.

© 2022, SimonsVoss Technologies GmbH, Unterföhring

All rights are reserved. Text, images and diagrams are protected under copyright law.

The content of this document must not be copied, distributed or modified. You can find more information on our website. Subject to technical changes.

SimonsVoss and MobileKey are registered brands belonging to SimonsVoss.

SimonsVoss
technologies

Made in Germany

A BRAND OF



ALLEGION™