

30
60

 VOSS

Locking cylinder (Z4) DoorMonitoring

Manual

17.09.2024

Simons  Voss
technologies

Contents

1.	General information.....	3
1.1	Description.....	3
1.2	Specifications.....	4
2.	Intended use.....	6
3.	General safety instructions	7
4.	Product specific safety notices.....	10
5.	Initial operation	13
5.1	Prerequisites	13
5.2	First steps.....	15
5.2.1	Add locking device.....	15
5.2.2	Add ID medium	17
5.2.3	Programming	19
5.3	Configuration	20
5.3.1	Locking devices.....	20
5.3.2	Network.....	32
5.3.3	Access list	51
5.4	Installation and fitting.....	53
5.4.1	Magnet installation	56
5.4.2	Functions test	57
5.4.3	Use in escape doors.....	68
6.	Day-to-day operation.....	70
6.1	Displays	70
6.2	Read component.....	73
7.	Possible DoorMonitoring states of locking cylinders.....	76
8.	Maintenance.....	77
8.1	Audible signals.....	77
8.2	Batteries.....	77
8.3	Error diagnosis.....	81
9.	Accessories.....	86
10.	Technical specifications.....	87
11.	Declaration of conformity.....	88
12.	Help and other information	89

1. General information

This manual is a supplementary document for the 'Digital Locking Cylinder and Digital Half Cylinder 3061 – TN4' manual. The aforementioned document describes the installation, operation and battery replacement for the TN4 cylinder generation, which is also used for the DoorMonitoring (DM) cylinder. The safety instructions are also listed in the document, which are also valid for the DM Cylinder.

This particular document describes the DM Cylinder's functions. When the basic functions are used, the DM Cylinder behaves in exactly the same way as a SimonsVoss digital locking cylinder. For this reason, this product description only deals with the special features of the DM Cylinder. Reference is made to the product manual for Digital Locking and Half Cylinder 3061 – TN4, its installation and handling.

1.1 Description

Door Monitoring Cylinder 3061 [DM Cylinder] is an electronic locking cylinder with integrated door monitoring. The integrated door monitoring system in the DM Cylinder is fitted without any wiring to the door.

Sensors within the DM Cylinder monitor the rotation of the cam. Sensors in the intelligent fastening screw monitor the door's opening status.

The DoorMonitoring Cylinder [DM] logs access events (access lists) and monitors door status and changes to door status (open, closed, locked, securely locked, manipulation attempt and forced entry).

The following door statuses are logged:

- Door – open or closed
- Cam rotated once/twice (maximum four times) - door - unlocked / locked / securely locked
- Alarm

These door statuses can be transmitted via the network and to the software, where they can be displayed, so that the user can see the transmitted status easily.

The software allows you to define events which trigger a definable, time-dependent response, such as an email or a pop-up window with a warning, when the status of a locking device changes.

All changes are logged in the access list, including the transponder ID, date and time, which the locking system operator or a security officer can then upload and evaluate if necessary.

1.2 Specifications



NOTE

DM cylinders must not be used in multi-lock systems with gears (gear locking devices).

DM.AP2 cylinders without bolt monitoring are an exception and can also be used in multi-lock systems with gears.

Standard design

The DM Cylinder is supplied in the following standard configuration:

- .DM DoorMonitoring
- .G2 available as G2 only
- .ZK access control, time zone management and events logging

The following accessories must be ordered with the standard configuration:

- Z4.DM.dd.SCREW.n Fastening Screw



NOTE

You must indicate the backset when ordering the fastening screw

The fastening screw is manufactured to match the backset and is a few millimetres longer

Information is only correctly transferred to the cylinder if the fastening screw is the right length.

dd represents the lock's backset. Standard fastening screws are supplied for backsets between 25 and 110 mm at increments of 5 mm. Greater lengths are possible at increments of 5 mm.

Options

The following options are available for the DM Cylinder:

- .FD - freely rotating
- .AP2 - anti-panic cylinder (no monitoring in the bolt position)
- .HZ - half cylinder
- .FH - fire retardant version (increased transmission range)
- .WN(M).LN.I Integrated LockNode, with or without auto-configuration

Installation lengths

The DM Cylinder is supplied at 30-35mm and larger (outside – inside).

Order codes

Refer to the respective current price list or the current product catalogue for the corresponding product codes.

2. Intended use

Digital SimonsVoss Locking Cylinder 3061 are installed in designated door locks, such as DIN mortise locks, to integrate them into a digital locking system.

The digital Locking Cylinder 3061 may only be used for its intended purpose in a designated door locking device. No other use is permitted.

Digital Locking Cylinder 3061s are available in various lengths. The selection of the proper size is of significance. The length of the locking cylinder is printed on the packaging and can be measured at any time. If the cylinder is too short, the handles cannot be fitted. If the cylinder is too long, it may be ripped out of the locking device. The may not protrude more than 3 mm on each side of the door to ensure proper operation.

The product may not be changed in any way, other than in compliance with the changes described in the instructions.

3. General safety instructions

Signal word: Possible immediate effects of non-compliance

WARNING: Death or serious injury (possible, but unlikely)

CAUTION: Minor injury

IMPORTANT: Property damage or malfunction

NOTE: Low or none



WARNING

Blocked access

Access through a door may stay blocked due to incorrectly fitted and/or incorrectly programmed components. SimonsVoss Technologies GmbH is not liable for the consequences of blocked access such as access to injured or endangered persons, material damage or other damage!

Blocked access through manipulation of the product

If you change the product on your own, malfunctions can occur and access through a door can be blocked.

- Modify the product only when needed and only in the manner described in the documentation.

Do not swallow battery. Danger of burns from hazardous substances

This product contains lithium button cell batteries. Swallowing the button cell battery, in can result in severe internal burns leading to death in as little as two hours.

1. Keep new and used batteries away from children.
2. If the battery compartment does not close securely, cease using the product and keep it away from children.
3. If you think batteries have been swallowed or are in any part of the body, seek medical attention immediately.

Risk of explosion due to incorrect battery type

Inserting the wrong type of battery can cause an explosion.

- Only use the batteries specified in the technical data.



CAUTION

Fire hazard posed by batteries

The batteries used may pose a fire or burn hazard if handled incorrectly.

1. Do not try to charge, open, heat or burn the batteries.
2. Do not short-circuit the batteries.

IMPORTANT

Damage resulting from electrostatic discharge (ESD) when enclosure is open

This product contains electronic components that may be damaged by electrostatic discharges.

1. Use ESD-compliant working materials (e.g. Grounding strap).
2. Ground yourself before carrying out any work that could bring you into contact with the electronics. For this purpose, touch earthed metallic surfaces (e.g. door frames, water pipes or heating valves).

Damage resulting from liquids

This product contains electronic and/or mechanic components that may be damaged by liquids of any kind.

- ❑ Keep liquids away from the electronics.

Damage resulting from aggressive cleaning agents

The surface of this product may be damaged as a result of the use of unsuitable cleaning agents.

- ❑ Only use cleaning agents that are suitable for plastic or metal surfaces.

Damage as a result of mechanical impact

This product contains electronic components that may be damaged by mechanical impacts of any kind.

1. Avoid touching the electronics.
2. Avoid other mechanical influences on the electronics.

Damage due to polarity reversal

This product contains electronic components that may be damaged by reverse polarity of the power source.

- ❑ Do not reverse the polarity of the voltage source (batteries or mains adapters).

Operational malfunction due to radio interference

This product may be affected by electromagnetic or magnetic interference.

- ❑ Do not mount or place the product directly next to devices that could cause electromagnetic or magnetic interference (switching power supplies!).

Communication interference due to metallic surfaces

This product communicates wirelessly. Metallic surfaces can greatly reduce the range of the product.

- ❑ Do not mount or place the product on or near metallic surfaces.



NOTE

Intended use

SimonsVoss-products are designed exclusively for opening and closing doors and similar objects.

- ❑ Do not use SimonsVoss products for any other purposes.

Malfunctions due to poor contact or different discharge

Contact surfaces that are too small/contaminated or different discharged batteries can lead to malfunctions.

1. Only use batteries that are approved by SimonsVoss.
2. Do not touch the contacts of the new batteries with your hands.
3. Use clean and grease-free gloves.
4. Always replace all batteries at the same time.

Different times for G2 locks

The internal time unit of the G2 locks has a technical tolerance of up to ± 15 minutes per year.

- ❑ Regularly reprogram time-critical locking devices.

Qualifications required

The installation and commissioning requires specialized knowledge.

- ❑ Only trained personnel may install and commission the product.

Incorrect installation

SimonsVoss Technologies GmbH accepts no liability for damage caused to doors or components due to incorrect fitting or installation.

Modifications or further technical developments cannot be excluded and may be implemented without notice.

The German language version is the original instruction manual. Other languages (drafting in the contract language) are translations of the original instructions.

Read and follow all installation, installation, and commissioning instructions. Pass these instructions and any maintenance instructions to the user.

4. Product specific safety notices



WARNING

Escape door function malfunction

The use of unsuitable components or ones that are not ready for operation can impair the function of an escape door. If you use the anti-panic cylinder in non-approved locks, the escape door function may be impaired and cannot be released again.

1. Make sure that all parts of the lock are ready for operation.
2. Make sure that the panic function of the mortise lock is ensured.
3. Please refer to the documentation of the lock manufacturer.
4. Use the anti-panic cylinder within the specified temperature range.
5. Perform a function test after installing the anti-panic cylinder or changing its battery.



CAUTION

Use of the anti-panic version of the locking cylinder in non-approved locks

If you use the anti-panic version of the locking cylinder in unauthorised locks, the escape door function may be impaired and cannot be released again.

1. Only use the anti-panic version of the locking cylinder in locks for which the locking cylinder is expressly approved.
2. Please refer to the documentation of the respective lock manufacturer.
3. Contact SimonsVoss Technologies GmbH for further information on this subject (see *Help and other information* [► 89]).

Hand injuries from carrier springing back

A spring-loaded carrier is used in the anti-panic construction of the closing cylinder. This carrier can spring back when it is not installed, causing hand injuries.

- Do not hold the anti-panic construction of the closing cylinders in the area of the carrier.

IMPORTANT

Damage caused by moisture in outdoor use

Moisture can damage the electronics.

1. If you want to use the locking cylinder for outdoor applications or in high humidity (bathrooms or washrooms), use the WP version.
2. Carefully insert the locking cylinder to avoid damaging the O-rings.

Mechanical damage to the thumb turn as a result of obstacles

If the thumb turn can knock against the wall or other objects as a result of the installation situation, it may become damaged.

- In such situations, use a suitable door stop.

Mechanical damage to the thumb turn through misuse as door-opener

Some doors are very heavy and solidly constructed. The thumb turn is not suitable for opening such doors.

1. Don't pull the thumb turn to open doors.
2. Make suitable door openers available (suitable handles) to avoid misuse of the thumb turn.

DoorMonitoring in gear locks

Door monitoring cylinders are not suitable for operation in multi-lock systems with gear (gear locking devices). Except: DM.AP2, without bolt monitoring.

- Do not use door monitoring cylinders in gear locking devices.



NOTE

Maintenance interval of not more than one month for emergency exit locks

As per European standard EN 179, Appendix C, all components in a locking device must be checked at intervals no greater than one month to ensure that they are in satisfactory working order as part of emergency exit locking device maintenance.

Locking up of persons without means of identification

The freely-rotating construction of the closing cylinder can only be opened with a means of identification from both sides.

- Ensure that no persons without means of identification are in the secured area.

Length of locking system password

For security reasons, the locking system password must consist of at least 8 characters. The code length for digital closing cylinders (*and for System 3060/3061 and MobileKey*) corresponds to 2¹⁶⁸ Bit.

Fault in the interior knob due to moisture

The inner knob of the closing cylinder is of protection class IP40 and is thus not protected from moisture.

- Ensure that the interior knob cannot come into contact with water.

Battery changes may only be carried out by trained personnel and only with the intended battery key (Z4.SCHLUESSEL)!

Programming with obsolete LSM version

New components can only be programmed with the current version of LSM.

Difficulty of operation of the lock due to stiff latch or bolt

If the latch or bolt of the mortice lock are stiff, the closing cylinder will also be stiff.

- ❑ Check that the latch or the bolt of the mortice lock are free-moving.

Fitting error or incorrect order

If you make a mistake in measuring the door and order a closing cylinder, the closing cylinder will not fit.

- ❑ Check the dimensions of the door again before ordering.
-

5. Initial operation

Refer to the 'Digital Locking Cylinder and Half Cylinder – TN4' product manual for general installation instructions. The manual describes how the different cylinder versions are fitted.

This DM Cylinder manual that only deals with the special features of the DM Cylinder. You must comply with the following steps when installing and putting the DM Cylinder into operation:

- Replace the cover on the active side with the WaveNet network cover
- Set up the DM Cylinder in LSM and programme the cylinder
- Install the DM Cylinder (see below)
- Use a PC or CommNode Server to put the network into operation locally (see FAQ entry 'WaveNet via CommNode Server: step by step' under FAQ in the Support section on the SimonsVoss website [www.simonsvoss.com]).
- Incorporate the cylinder (cylinder's LN.I) into the network; see manual on WaveNet radio network. You should pay attention to the signal strength when doing so; the level should not fall below minus 70 dBm.
- Perform functional test with an authorised ID medium

5.1 Prerequisites

The DM Cylinder imposes the following minimum requirements for the locking system and LSM:

- LSM 3.2 SP1 Basic, Business or Professional installed
- G2 or G2+G1 locking system
- The software LSM.Business with the modules LSM Online and LSM Network xx (128 or Enterprise) is required for an online connection (tasks and responses/events) to the DM Cylinder

The appropriate software modules and hardware components must be installed to ensure door statuses in LSM can be further processed. They define key events in the locking system and the action required. The person responsible is thus informed by email if a fire door stays open too long, for example.

- LSM Business
- LSM NETWORK xx
- LSM ONLINE
- WaveNet components (router and network covers)

Different functions are available, depending on the configuration:

	Offline	Online in LSM Basic	Online in LSM Business
Tracking to identify who last locked/unlocked a door	Upload access list with SmartCD	Access list with SmartCD and WaveNet	Access list with SmartCD and WaveNet
Door status monitoring	No	Yes/display in LSM	Yes/display in LSM
Transmission of alarms to the matrix	No	Yes. Display in matrix when LSM is open.	Yes. Display in matrix configuration of events and tasks
Generate events, such as a pop-up window	No	No	Yes
Incorporate lock with profile cylinder profile	Yes	Yes	Yes
Monitoring of an SLP* lock	No	No	Yes (with restrictions)

Tab. 1: DM Cylinders in different locking systems

*SLP: self-locking panic lock

5.2 First steps

5.2.1 Add locking device



Add new locking device

- ✓ You have added a database
- ✓ You have added a locking plan

1. Click on [New locking device]



The screenshot shows a software configuration window titled 'Add new locking device'. The window contains several input fields and checkboxes. At the top left, there are labels for 'Serial number', 'Door', 'Type', and 'Lock ID'. The 'Serial number' field contains 'L-00007', 'Door' contains 'no', 'Type' contains 'G2 Door Monitoring Cylinder', and 'Lock ID' contains '0'. To the right of these fields is an 'Auto' checkbox which is checked, and a 'Configuration' button. Below these fields are two more checkboxes: 'Insert door' (checked) and 'Add to area' (checked). Under 'Insert door' are two empty text boxes for 'Door/location' and 'Room number'. Under 'Add to area' are two dropdown menus for 'Locking system' (set to 'Dr. Kiefer') and 'Area' (set to '[System area]'). A warning message at the bottom right states: 'Lock of the type selected cannot be added to a G1-only locking system.' At the bottom of the window are five buttons: 'Edit', 'New', 'Apply', 'Exit', and 'Help'.

Fig. 1: Add new locking device

2. Select the locking device type 'G2 DoorMonitoring Cylinder'
3. Enter a door name
4. Click on [Apply]
5. Click on [Finish]

5.2.2 Add ID medium

Add new transponder



Locking System Management - [Dr Kiefer - New transponder]

File Database View Wizards Edit Reports Data record Programming Network Options Window Help

Serial number: T-00004 Auto Deactivated

Owner: no

Type: G2 Transponder

Description:

Assigned transponder groups:

Locking system	Level	Transponder group	TID G2	G2 Time group	SID Ext

Set up new person

First name: Anabell

Last name: Dr. Kiefer

Personnel number: P-00006 Auto

Department:

Address:

Telephone:

Add to group

Locking system: [Dr. Kiefer]

Transponder group: [System group]

Buttons: Edit, New, Apply, Exit, Help

idle PUMBA : COM(*) TCP port:6001 Admin NUM

Fig. 2: Add new transponder

1. Press [New transponder] button

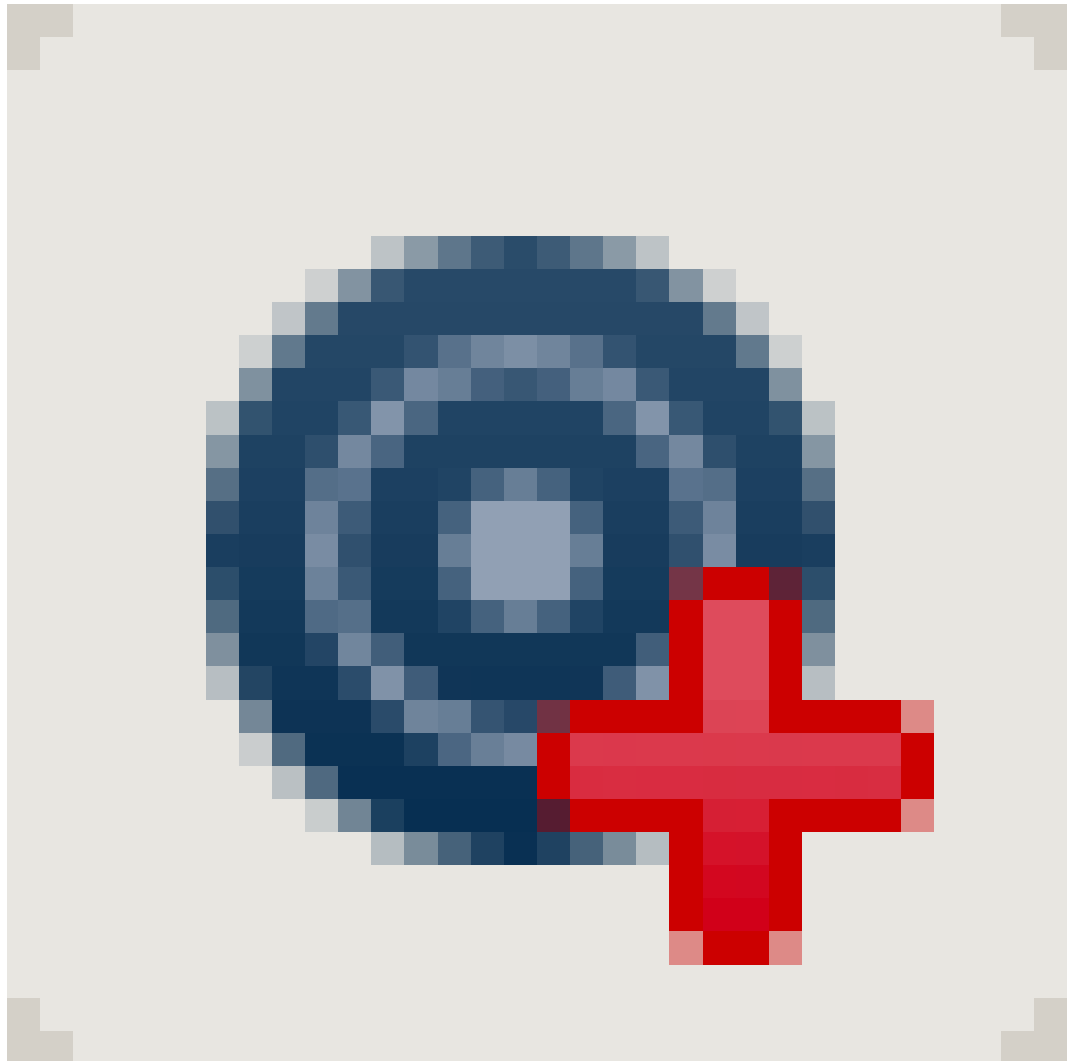

2. Select type
3. Assign person's name
4. [Apply]
5. [Finish]
6. Set authorisation cross in the locking plan

5.2.3 Programming

Programme locking device



Locking system: John Smith

Door/lock: Main entrance / L-00001

Programming Lock

Programming

<input checked="" type="checkbox"/> Configuration	<input checked="" type="checkbox"/> Password green
<input checked="" type="checkbox"/> Password	<input checked="" type="checkbox"/> Password blue
<input checked="" type="checkbox"/> Lock ID & Locking system ID	<input checked="" type="checkbox"/> Password red
<input checked="" type="checkbox"/> Time-zones	<input checked="" type="checkbox"/> Extended configuration
<input checked="" type="checkbox"/> Holiday list	

Program authorisations

Don't change
 Update
 Renew

Programming Exit

- Place locking device in front of the programming device - about 20 cm away
- Highlight locking device
- Press [Programming flash]
- [Programme]

5.3 Configuration

5.3.1 Locking devices

5.3.1.1 Cylinder

A cylinder's properties can be configured precisely, so that the door behaves exactly as you wish.

Prerequisites

- The LSM software needs to be open
- At least one cylinder has been added to the locking plan
- You can see the locking plan matrix on the monitor screen

Double-click on the cylinder on the locking plan screen

Name

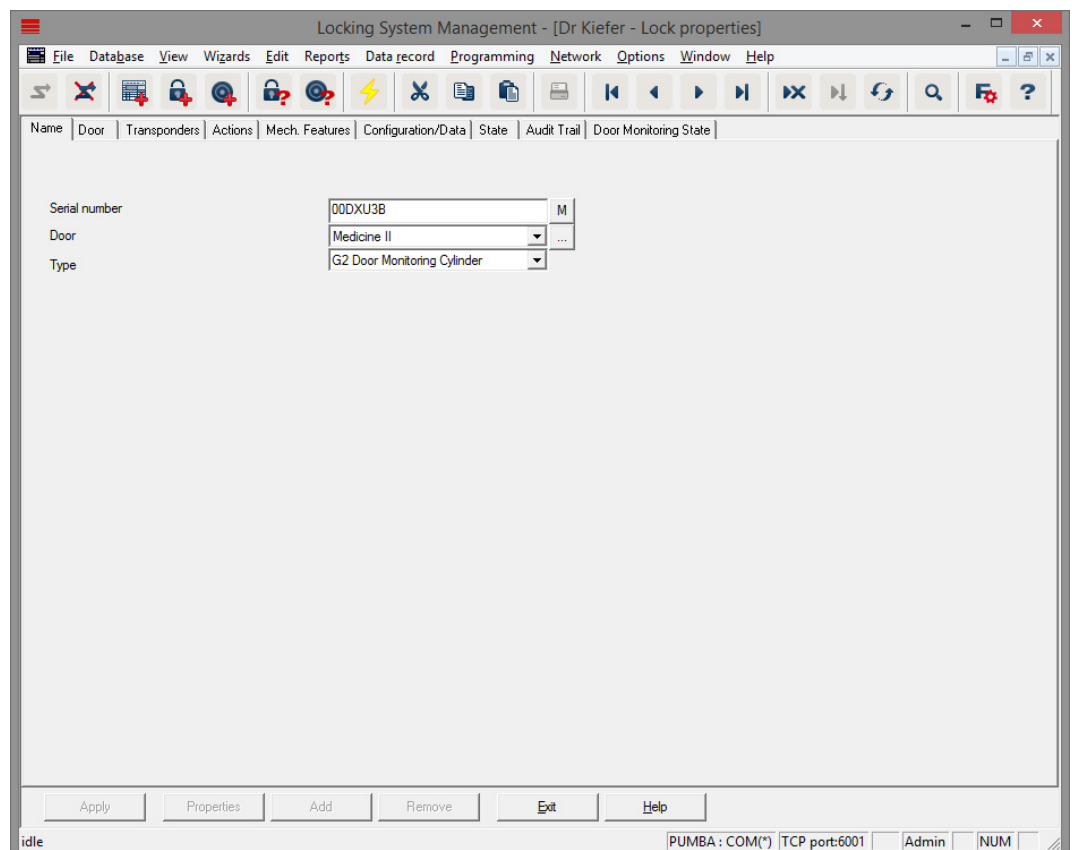

Fig. 3: 'Name' tab

The cylinder properties are opened. You will see the 'Name' tab

- You will see the name of the door Click on the name field to change the name if required

- You can use the serial number to refer to the cylinder with a distinct identifier. The number is stored in the electronics and engraved into the cylinder body
- The type shows which locking device type it is.

Door

The 'Door' tab provides information on the door

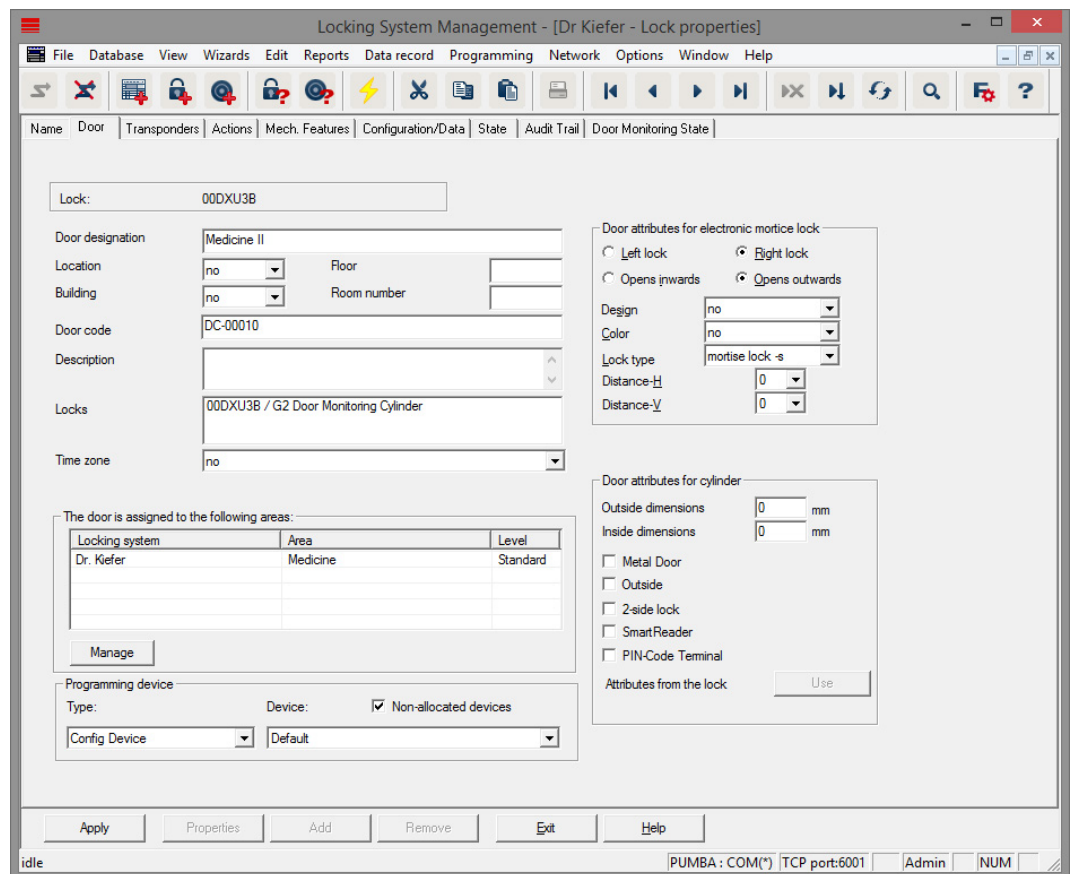

Fig. 4: 'Door' tab

- Locking device: ID number for locking device
- Door identifier: the door name
- Location: this is where the location can be selected if one has been added
- Building: this is where the building can be selected if one has been added
- Floor: the floor on which the door is situated
- Room number: identifier for the room number
- Door code: the door ID will be generated automatically
- Description: field for additional information

- Locking devices: locking devices which are assigned to the door
- Time zone: list of the time zone plans which can be assigned to the door. This allows you to authorise certain users to use a door at certain times only
- Areas: information about the locking system, the area and the level
- Programming device: how is the locking device programmed?
 - Config device: stationary programming device, such as SmartCD
 - LockNode: network module. Flush fitted next to the door
 - WaveNet node: CentralNode or RouterNode in connection with an internal network module (LN.I). The network card is integrated into the thumb-turn cover with LN.I
- Door attributes for mortise lock: detailed information on the lock
- Door attributes for locking cylinder: detailed information on the cylinder

Transponders

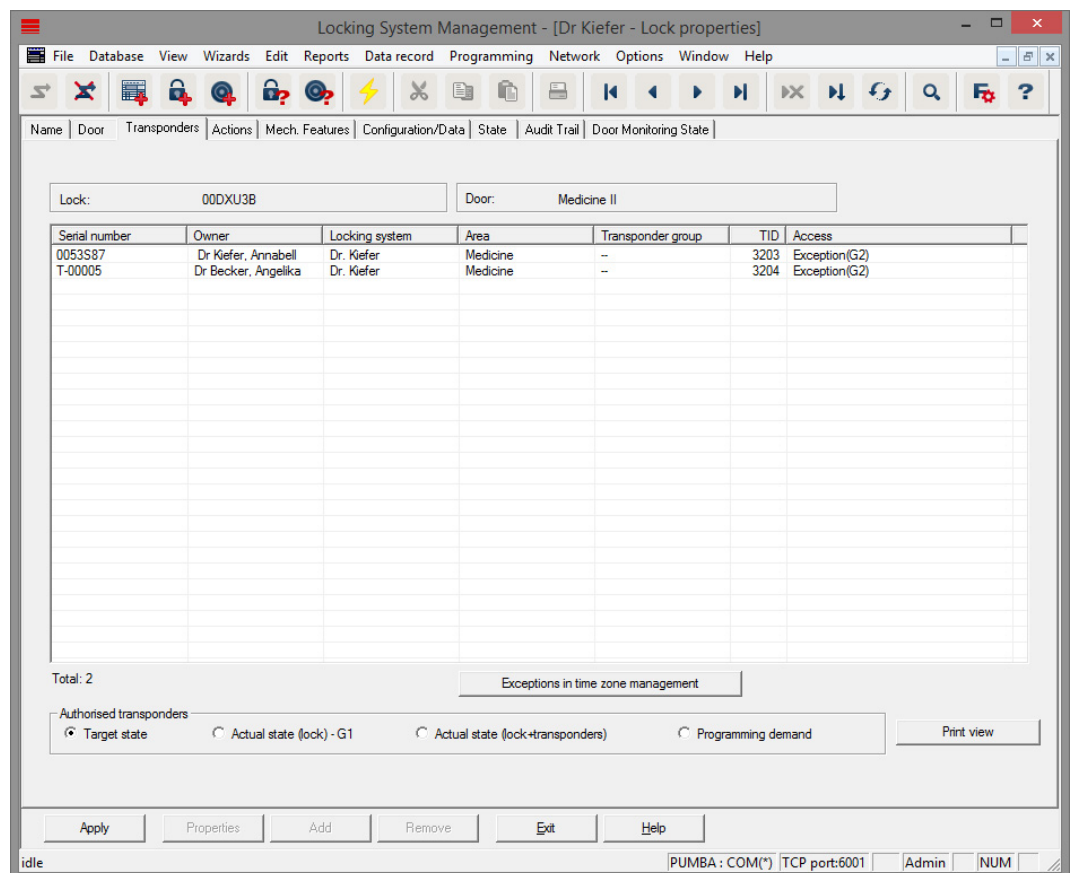

Fig. 5: 'Transponders' tab

The 'Transponders' tab lists the authorised transponders

Actions

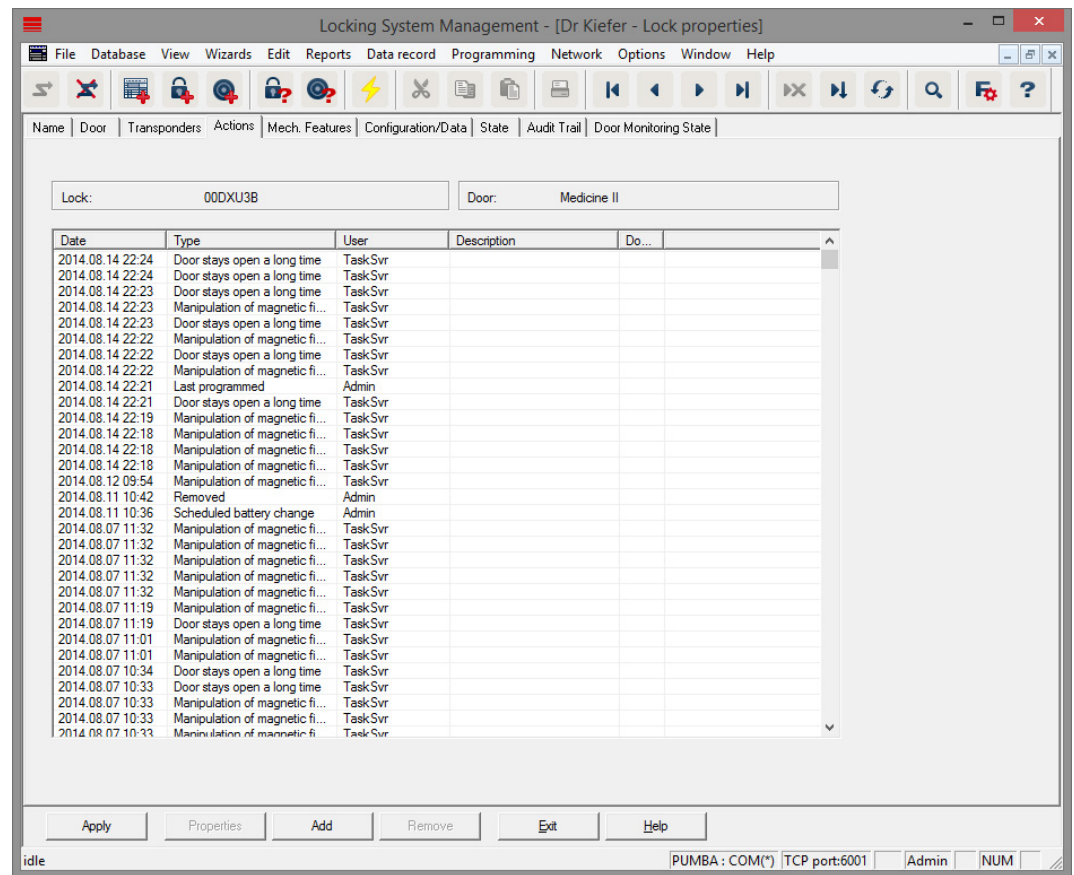

Fig. 6: 'Actions' tab

The 'Actions' tab lists the completed programming processes

The screenshot shows a 'New action' dialog box with the following fields and controls:

- Action:** A dropdown menu with 'Removed' selected.
- Date:** A date field showing '16 August 2014'.
- Time:** A time field showing '12:24:40'.
- Description:** A large empty text area.
- Save document in the Actions list:** A checkbox that is currently unchecked.
- Buttons:** 'OK' and 'Cancel' buttons at the bottom.

You can also log additional actions by pressing [Add]. You can use a pull-down menu to select different actions

- Removed
- Replaced
- Installed
- Last battery replacement
- Scheduled battery replacement

Features

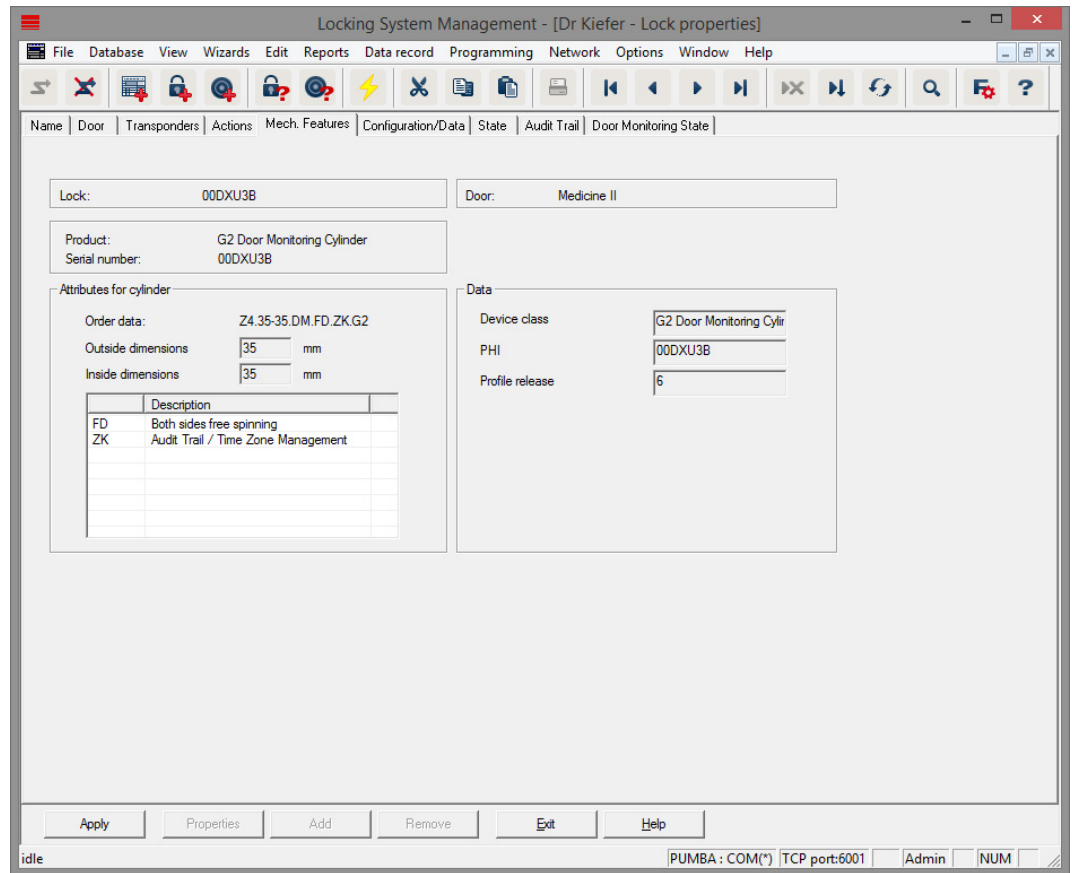

Fig. 7: 'Features' tab

The 'Features' tab provides detailed information on the locking device

- ❑ Locking device: the serial number of the cylinder. The PHI number is given as standard. You can enter your own serial number as an alternative
- ❑ Door: door name
- ❑ Ordering information: item code of locking device
- ❑ Outside dimension: length of the cylinder from the fastening screw thread to the outer edge of the profile cylinder
- ❑ Inside dimension: length of the cylinder from the fastening screw thread to the inner edge of the profile cylinder
- ❑ There is more information in the table, depending on the locking device type
- ❑ Device class: specification of the locking device class
- ❑ PHI: Physical Hardware Identifier. A unique ID number for components
- ❑ Profile release: the profile version

Configuration/data

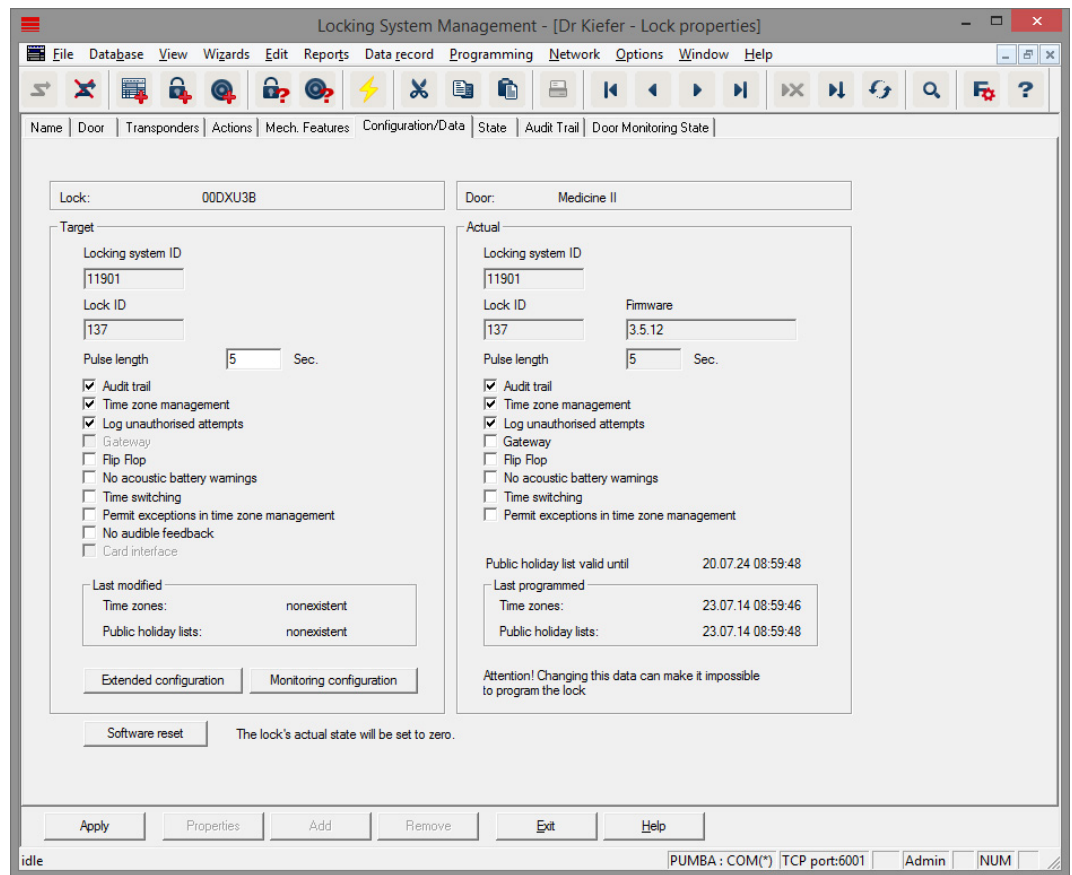

Fig. 8: 'Configuration/data' tab

The locking device is configured in the 'Configuration/data' tab

- You will see two sections: a target value and a current value section. The target value section allows you to configure how components should behave. The two sections will be identical once you have programmed the changes
- Pulse length: how long should the cylinder engage to open? 1-25 sec
- Access control: the cylinder logs which particular transponder is used at a particular time. The .ZK option is required
- Time zone control: certain people can open the door at specific times only. The .ZK option is required
- Logging unauthorised attempted access events: the cylinder logs when someone tries to open doors which they are not authorised to use
- Flip flop: the cylinder engages permanently until another authorisation is implemented. If flip-flop mode is selected, bolt monitoring in the DoorMonitoring Cylinder must be deactivated. The bolt position is only displayed correctly if FF mode is deactivated

- ❑ No audible battery warnings: the cylinder does not emit an audible signal when the battery needs changing
- ❑ Time switch-over function: the cylinder engages automatically/ manually at a specific time. You can set its exact behaviour under 'Extended configuration.' If the time switch-over function is selected, bolt monitoring in the DoorMonitoring Cylinder must be deactivated. The bolt position is only displayed correctly when the time switch-over function is deactivated
- ❑ Allow exceptions in time zone management (LSM Business and higher): exceptions can be configured in time zone management
- ❑ No audible programming feedback signals: the locking cylinder does not emit audible signals during the programming process
- ❑ Card interface: if a card reader is fitted to the cylinder, this is where you can activate the function.
- ❑ Extended configuration: this is where you can configure time switch-over behaviour. These options are active as soon as a time zone plan has been created
 - ❑ Automatic engage: the locking device automatically engages at the pre-set time
 - ❑ Manual engage: the locking device automatically disengages at the pre-set time. The locking device automatically engages when actuated with a transponder
 - ❑ Automatic disengage: the locking device automatically disengages at the pre-set time
 - ❑ Manual disengage: the locking device remains engaged at the pre-set time. The locking device permanently disengages when authorised
 - ❑ Transponder always active: authorised ID media are able to continue to lock the locking device while the locking device is engaged
 - ❑ Transponder only active if disengaged: authorised ID media are not able to lock the locking device while the locking device is engaged
- ❑ Software reset: the current status is re-set in the software, to re-programme components which have not been programmed completely, for example

Monitoring configuration

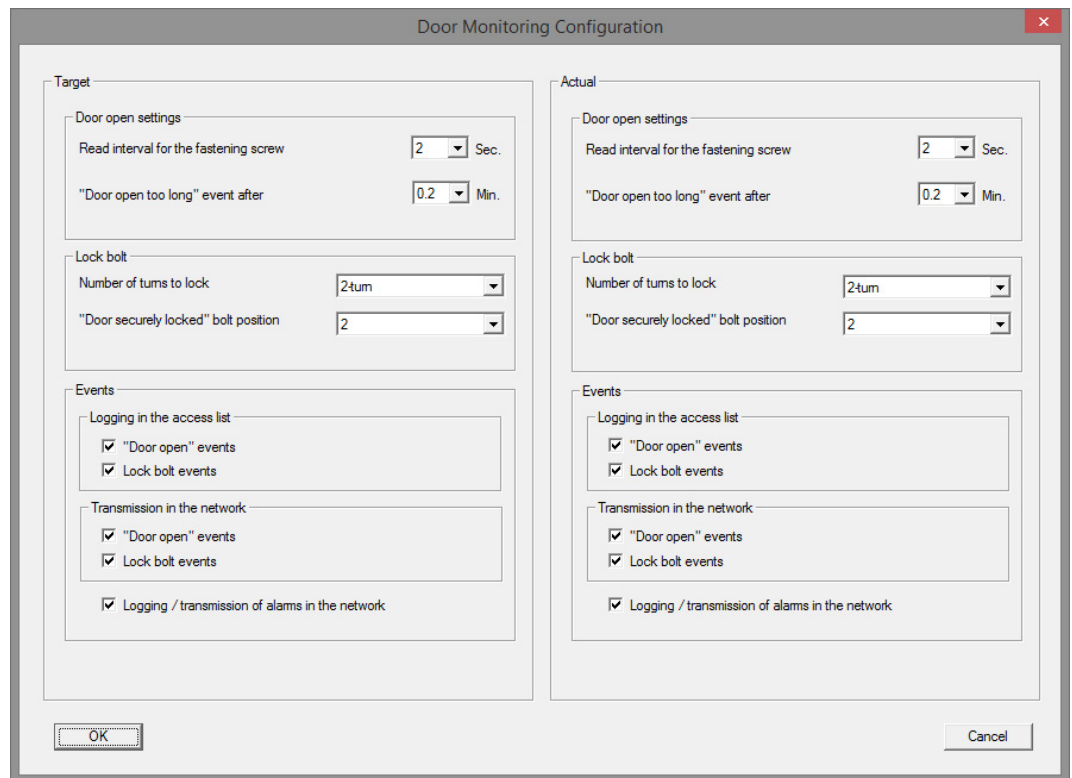

Fig. 9: 'Monitoring configuration' menu



NOTE

The monitoring configuration has a direct influence on power consumption in the cylinder.

The shorter the sampling interval is set for the fastening screw, the greater power consumption is.



NOTE

Changes to Door Monitoring configuration do not come into effect until the cylinder has been programmed

- Sampling interval for the fastening screw: The sensor in the fastening screw scans the magnetic field at adjustable intervals. The shorter the sampling interval is set, the more complete monitoring is, but also the greater power consumption is in the cylinder. A practical compromise between effective door monitoring and efficient power consumption would be 2 to 3 seconds. The function can also be switched off if opening of the door is not to be logged. Setting: off
- 'Door open too long' event after: a signal is sent to LSM after the pre-set time interval.

- Number of turns to lock: Depending on the lock, the bolt is fully extended after one or a number of turns, thus locking the door securely. You can set the number of turns in these menu items.



NOTE

The bolt position is not monitored in the .AP2 Anti-Panic Cylinder.

Select 'Off' for the number of turns for the .AP2 Cylinder

Select 'Off' for door securely locked position for the .AP2 Cylinder

- Logging of access list: this is where you enter whether 'Door open' and dead bolt events are to be saved to the access list
- Transmission in the network: this is where you enter whether 'Door open' and dead bolt events are to be saved in LSM via the WaveNet network
- Logging/forwarding of alarms in the network: this is where you enter whether alarms are to be saved in LSM via the WaveNet network. Forwarding must also be configured for the LNI via 'Network' » 'Administer WaveNet.' The alarm alerts transmitted are:
 - Door open too long
 - Tampering attempt
 - Door is open even though it registers as locked or securely locked



NOTE

If events are not logged in the access list, it will not be possible to establish at a later point in time who has used a particular door.

Status

Lock: 00DXU3B	Door: Medicine II
State during last read-out:	
Battery status	OK
<input type="checkbox"/> Emergency release	
<input type="checkbox"/> Deactivated	
<input type="checkbox"/> Engaged	
<input type="checkbox"/> Storage mode	

Fig. 10: 'Status' tab

The 'Status' tab shows the last status read in the locking device

- Battery status: indicates whether the batteries need to be replaced

- Emergency release: the software uses an emergency release to engage the cylinder
- Deactivated: the cylinder is deactivated. The cylinder will not engage even if an authorised transponder is used.
- Engaged: the cylinder is engaged.
- Storage mode: the batteries have discharged beyond the second warning level and the cylinder is in storage mode. This mode can be deactivated for 30 seconds using a G2 battery replacement transponder. The cylinder can then be opened with an authorised transponder during this time.

Access list

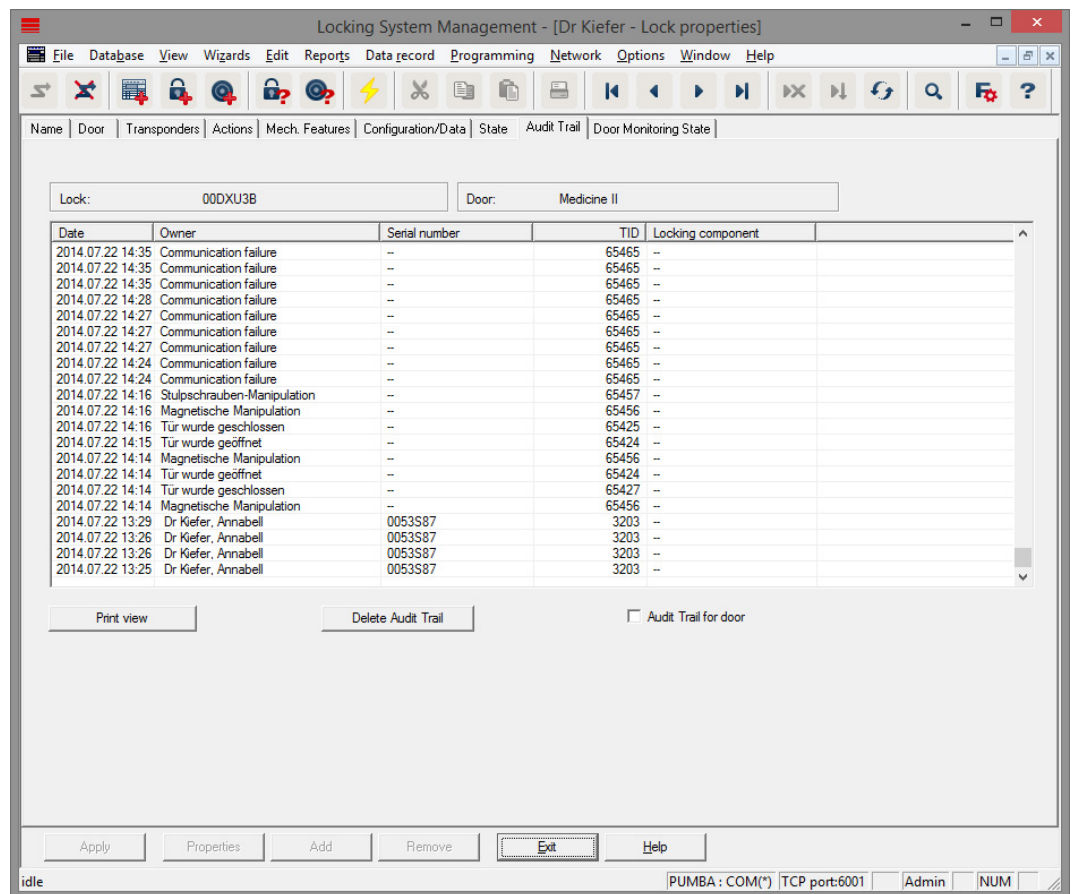

Fig. 17: 'Access list' tab

Locking devices with the .ZK option log authorised accesses with the date, time, name serial number and transponder ID

Access list for door: if more than one locking device is fitted to the door, accesses with all locking devices can be displayed

Click on [Print preview] to export the access list. You can use the print preview to print or export the list. Possible formats are: PDF, TXT, RPT, REC, CSV, TTX, HTML 3.2 /4.0, XLS, RTF, ODBC and XML

Door monitoring status

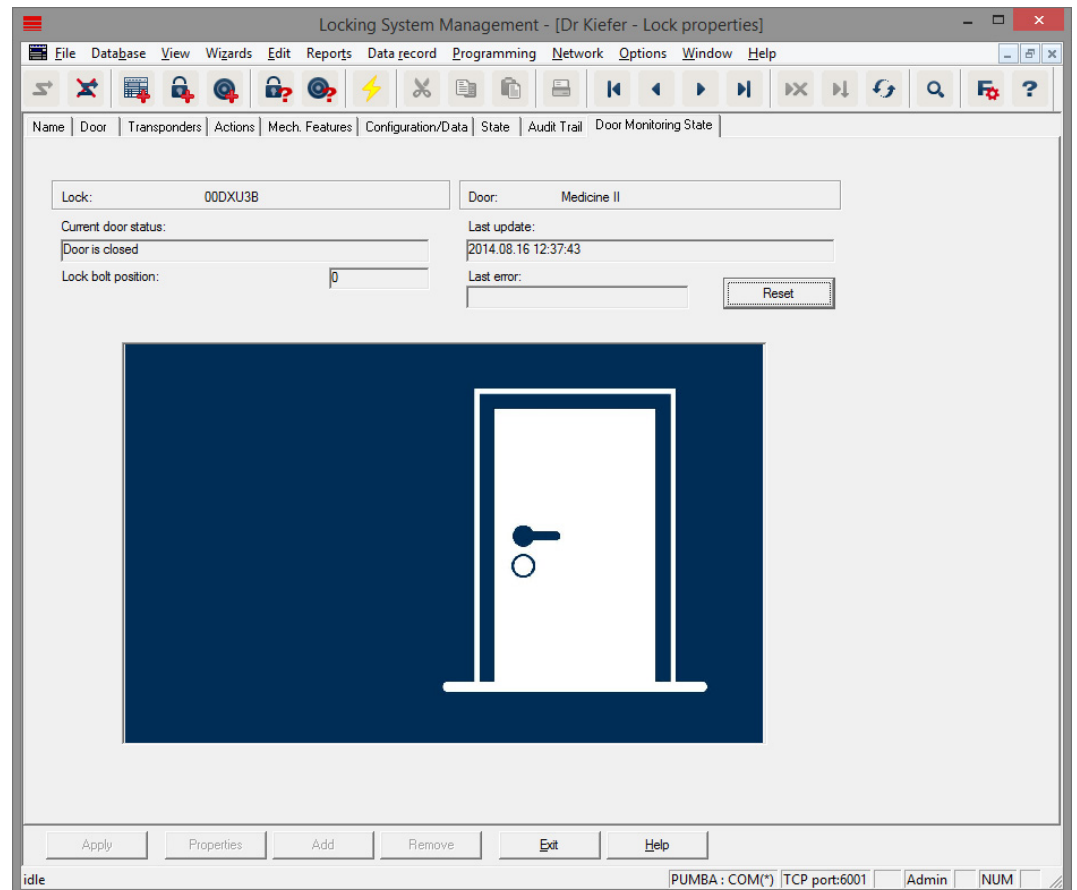

Fig. 12: 'Door monitoring status' tab

The 'Door monitoring status' tab shows the last status read in the locking device. You have two options for the status:

- The status is read automatically via an LN.I whenever a change occurs

or

- Read manually 'Programming' » Read locking device

■ Current door status:

- Door open too long
- Door open
- Door closed
- Door locked
- Door securely locked

- Lock bolt position: Bolt Position 0-4, depending on the number of turns to lock
- Last error:
 - undefined door status
 - Door open too long
 - Fastening screw has been manipulated (has been removed)
 - Magnetic field manipulation (fastening screw magnetic field too extensive)
 - Door has been forced open (door is opened despite locking)
- Reset: error messages must be reset manually

5.3.2 Network

The DoorMonitoring Cylinder allows the door status to be sent to LSM within seconds. The information is transmitted via the SimonsVoss WaveNet network

You will find detailed information on WaveNet installation in the WaveNet manual on the SimonsVoss website

Installing hardware

The easiest way to install is using a CentralNode and an LN.I

- WNM.CN.UR.IO: CentralNode with USB connection to PC and wireless interface for locking devices
- WNM.LN.I: thumb-turn network cover for a TN4 Cylinder for direct networking

- ✓ A database has been added
- ✓ The locking plan has been added
- ✓ A DoorMonitoring Cylinder has been added and programmed
- ✓ A transponder has been added and programmed with authorisation for the DM Cylinder
- ✓ The CentralNode is connect to the PC with a USB cable
- ✓ The drivers for the CentralNode are installed
- ✓ WaveNet Manager is installed
- ✓ LSM is open

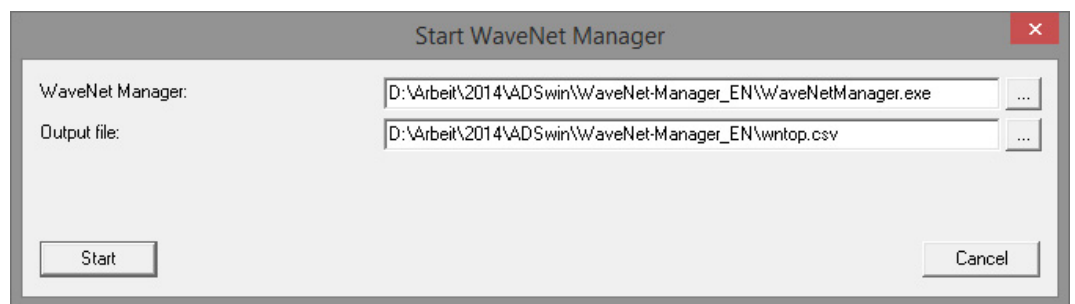

1. Start WaveNet Manager (Network > WaveNet manager)
2. Set the path for the WaveNetManager.exe and the output file
3. Click on [Start]

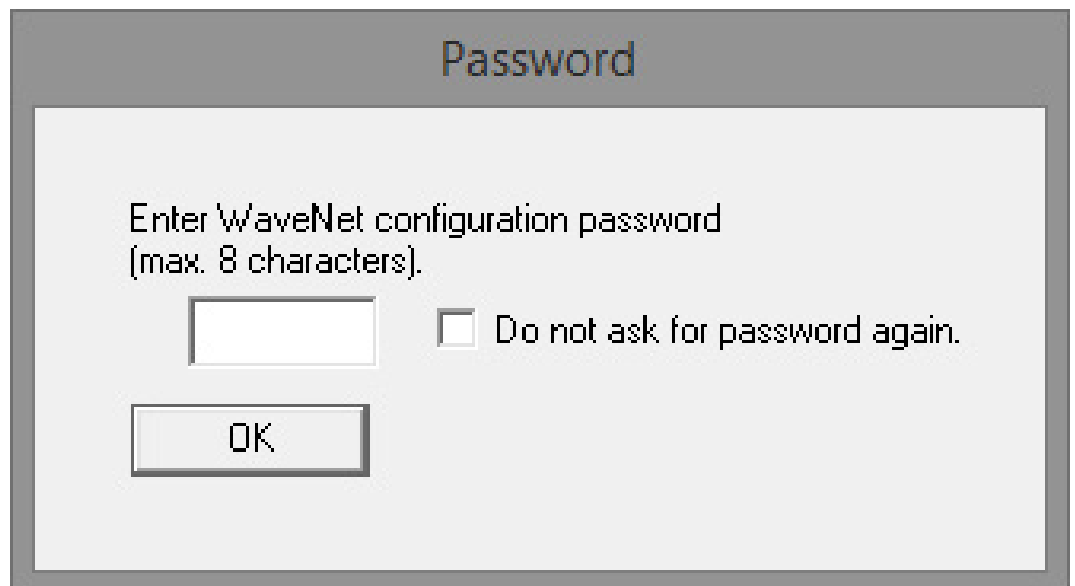

4. Issue a password for the WaveNet components. Click on [OK] to proceed
 - ↳ WaveNet Manager will start

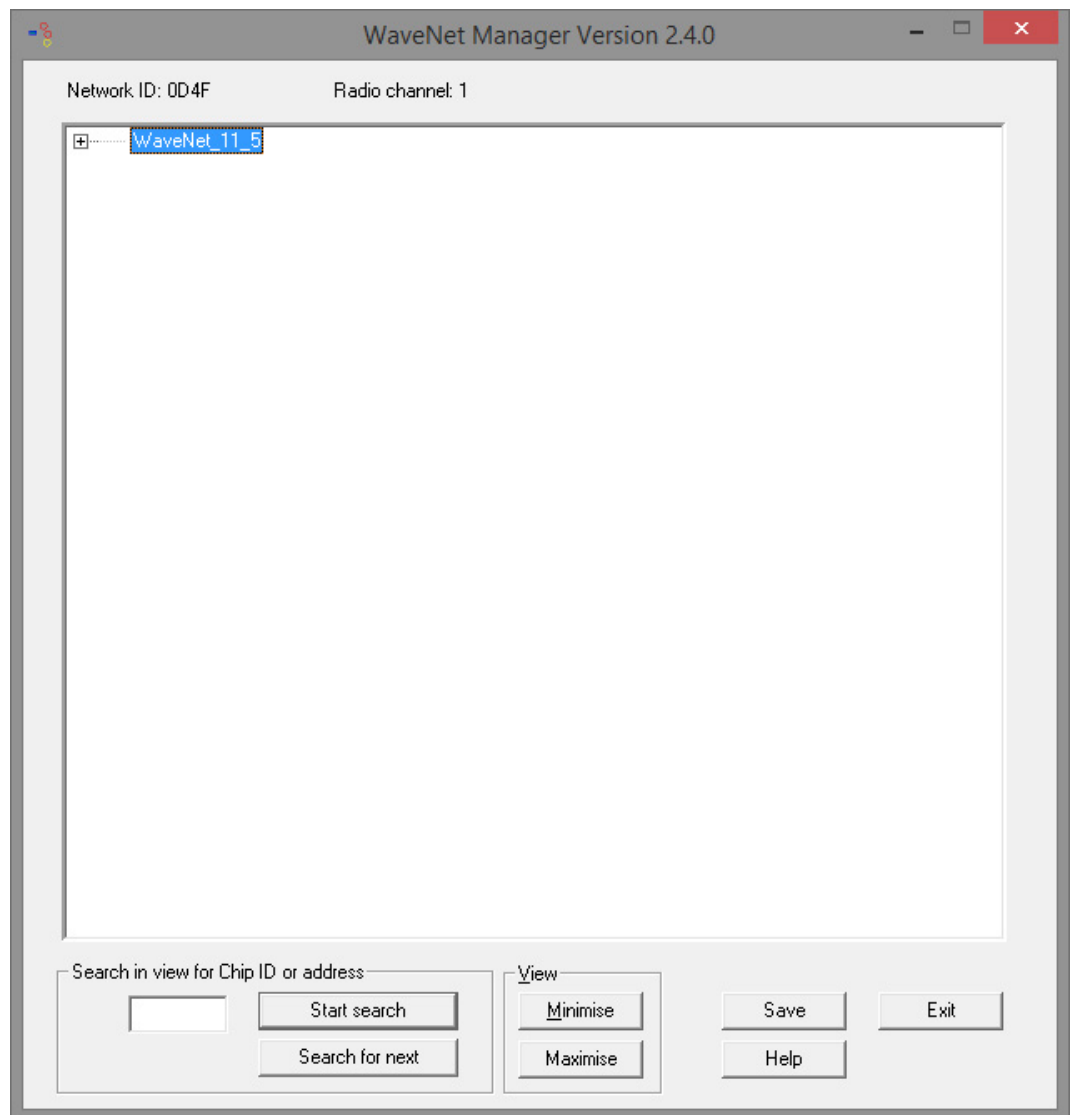

5. Double-click on 'WaveNet_11_5' or 'WaveNet_8_8' to start administration
↳ Administration will open

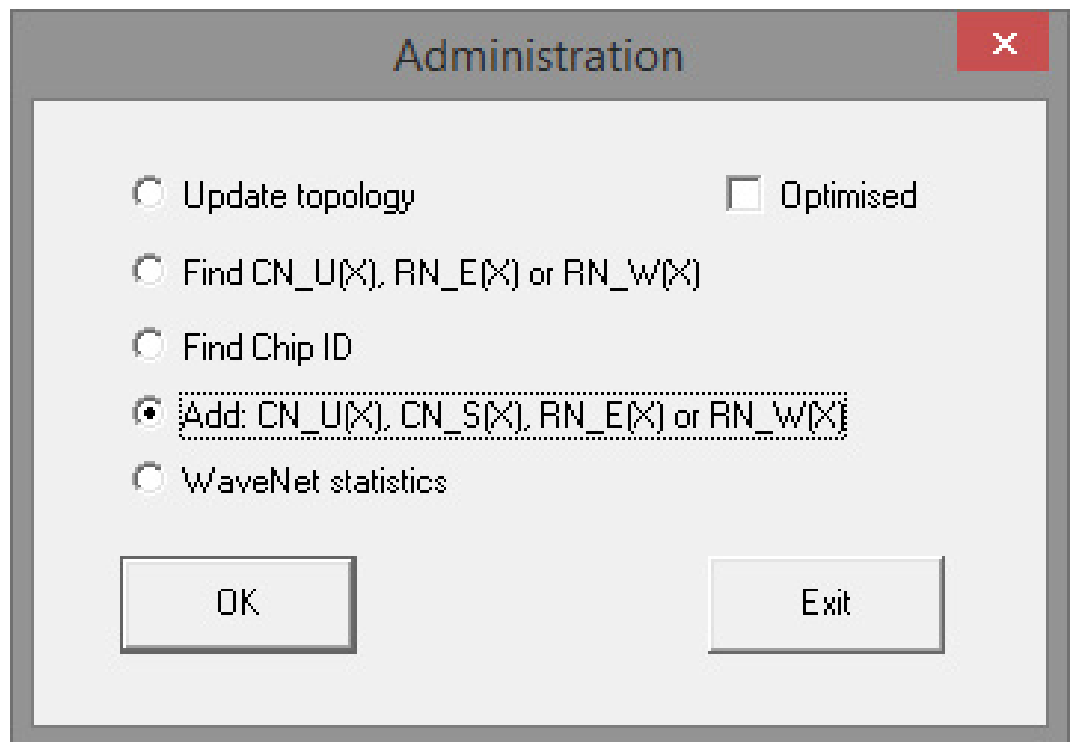

6. Select 'Add CN_U(X), CN_S(X), RN_E(X) or RN_W(X).' Click on [OK] to proceed
7. Change the radio frequency if necessary. Click on [Yes] to proceed
↳ The CentralNode is part of the network topology

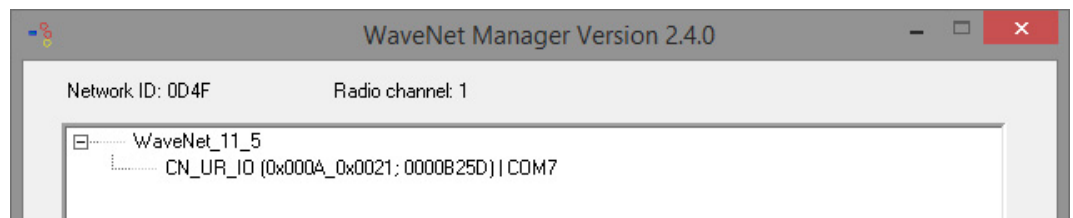

8. Double-click on the entry for the CentralNode
↳ CentralNode administration launches

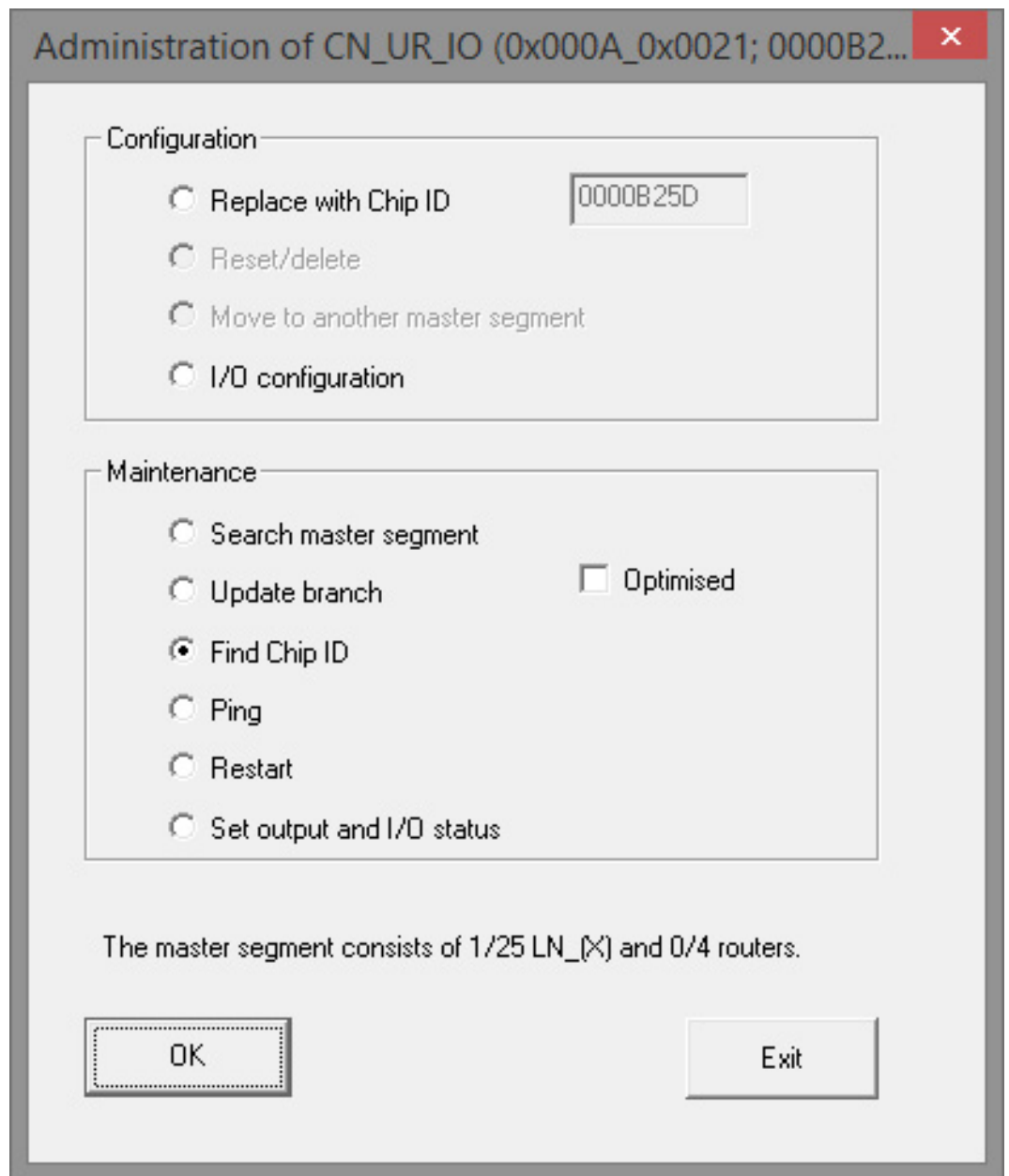

- 9. Highlight 'Search by chip ID.' Click on [OK] to proceed
- 10. Enter the network cover chip ID. You will find the chip ID on the network cover box and on the inside of the cover. Click on [Start] to proceed
 - ↳ The LN.I has been assigned to the CentralNode
- 11. [Apply] and [Finish]
 - ↳ The mask to import the topology will open

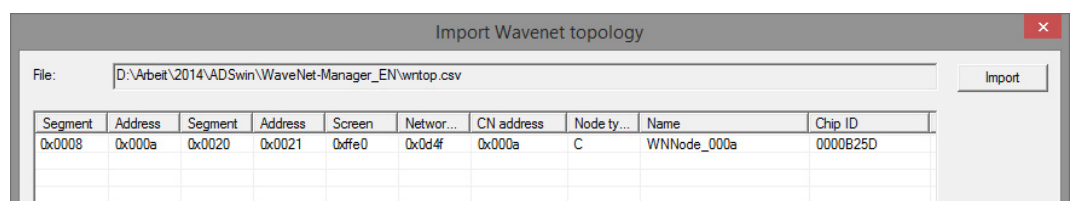

- 12. Click on [OK] to proceed

13. Double-click on the cylinder in the locking plan. This will open the cylinder properties
14. Open the 'Door' tab

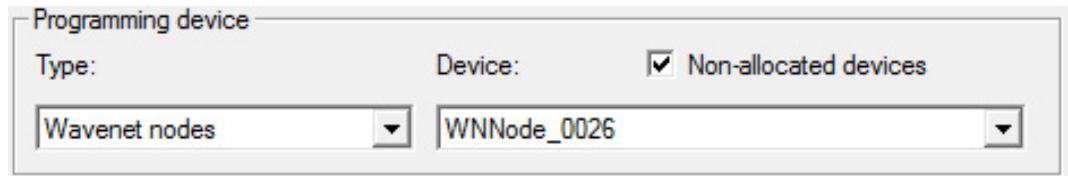

15. Change the type of config device to WaveNet node in the 'Programming device' section, so that programming tasks are implemented on the network
16. Click on [Apply] and [Finish] to proceed
 - ↳ The network is now set up ready for use
 - ↳ Programming tasks are now performed via the WaveNet node

Collective tasks

You can programme several locking devices at the same time using 'Collective tasks'

1. Click on 'Network' and select 'Collective tasks' » 'WaveNet node'
2. Highlight the components which are to be programmed
3. Click on [Configure automatically]
 - ↳ The programming tasks are distributed via the network

Forward status change

The forwarding of status changes must be activated for locking devices

1. Click on 'Network' in the menu and select 'Administer WaveNet'

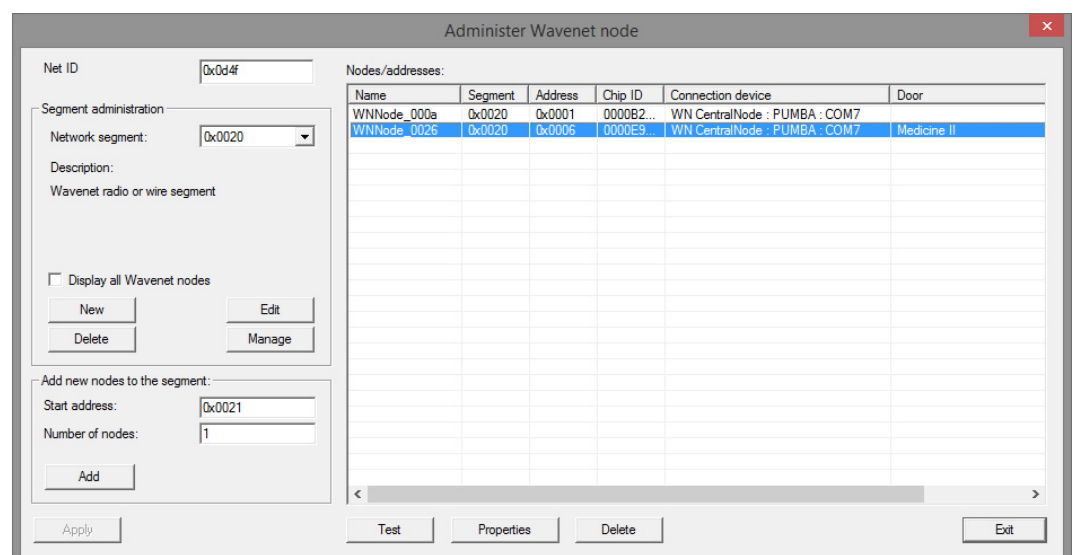

2. Select the network segment with the locking device in Segment administration
3. Highlight the locking device and open [Properties]

Wavenet network node properties

Name: WNNode_0026

Node type: LockNode

Interfaces: LNI

Chip ID: 0000E96F

Address: 0x0026

Firmware: 16.1 Firmware TM: 30.9

Connection device: WN CentralNode : PUMBA : COM7

Description:

State

- Output is set
- Input 1
- Input 2
- Input 3
- Battery state critical

Configuration

- Activate event forwarding
- Programming demand

Buttons: Programming, Test, Set Output, Reset output, Apply, Exit

4. Highlight 'Activate forwarding of events' in the 'Configuration' section
 5. Click on 'Programme'
- ↳ Forwarding of events is now set up

Reset/replace LockNode

If the DM Cylinder does not automatically forward status changes to the door after configuration and initial operation, the LockNode may be configured incorrectly. If this is the case, reset the LockNode. You can also replace a LockNode using the same process.

- ✓ The locking plan is open
 - ✓ The 'Network' column is visible in the locking plan
1. Find the LockNode WaveNet address. Position the mouse cursor on the 'W' for the locking device and write down the address
 2. Launch WaveNet Manager using 'Network' » 'WaveNet manager'
 3. Right-click on the locking device
 4. If the LockNode is reset, select 'Replace with chip ID' and maintain the ID entered
 5. If the LockNode is being replaced, enter the new chip ID
 6. Activate event forwarding by selecting 'Network' » 'Administer Wave-Net'

7. Select the segment with the LNI and open [Properties]

The screenshot shows a 'Wavenet network node properties' dialog box. The fields are as follows:

- Name: WNNode_0026
- Node type: LockNode
- Interfaces: LNI
- Chip ID: 0000E96F
- Address: 0x0026
- Firmware: 16.1
- Firmware TM: 30.9
- Connection device: WN CentralNode : PUMBA : COM7
- Description: (empty)
- State section:
 - Output is set
 - Input 1
 - Input 2
 - Input 3
 - Battery state critical
- Configuration section:
 - Activate event forwarding
 - Programming demand

Buttons: Apply, Test, Set Output, Reset output, Exit.

8. Highlight 'Activate forwarding of events'
9. Click on [Apply]
10. Click on [Programme]

5.3.2.1 CommNode server

Door statuses can be transmitted via the CommNode server in the LSM software. This enables you to manage tasks and events over the network.

- ✓ LSM software is installed.
 - ✓ In the case of LSM Business, you also need to set up the Comm Node server.
 - ✓ LSB Basic: the module for LSM Network 128 is enabled.
 - ✓ LSB Business: the modules LSM Network XX, LSM CommNode and LSM Online are enabled.
 - ✓ Advantage Database server installed and launched (for LSM Business)
 - ✓ You have administrator rights.
1. Install the CommNode server using the software DVD. Execute the commnode_setup_3_x_xx.exe file to do so
 2. After installation, execute the 'install_CommNodeSvr.bat' file
 3. The configuration files must be generated before the CommNode server service can be started. 'Network' » 'Communication node' » [New]
 4. 'Network' » 'Task manager'
 5. Generate config files. 'Network' » 'Communication node' » [Config files]
 6. Copy the netcfg.xml, appcfg.xml and msgcfg.xml files into the 'SimonsVoss Comm Node server' installation directory. Ensure that the CommNode server has write accesses to the installation directory
 7. Start the 'SimonsVoss CommNode server' service

You will find details on CommNode Server installation in the 'IT administration' software manual. You will find all manuals in the download section on the SimonsVoss website

5.3.2.2 Tasks

A task is a pre-defined job within LSM which the system is to carry out automatically. Such a task can be defined for one or more locking devices. The system can be configured in such a way that the tasks should be performed at a specific time or on a periodical basis.

These functions require that the system can be reached at all times. That is why they are only available in LSM Business with the LSM.Online module.

The tasks are set with priorities, so urgent tasks are performed first. You can determine the performance modalities (times, periods and type of task) using the menu item on the user interface. You can find more information in the 'LSM online' manual.

Two different tasks can be configured for the DM Cylinder, which are described in detail below:

- Configure DM Cylinder
- Read DM Cylinder

Task: DM Cylinder configuration

✓ CommNode server installed and launched

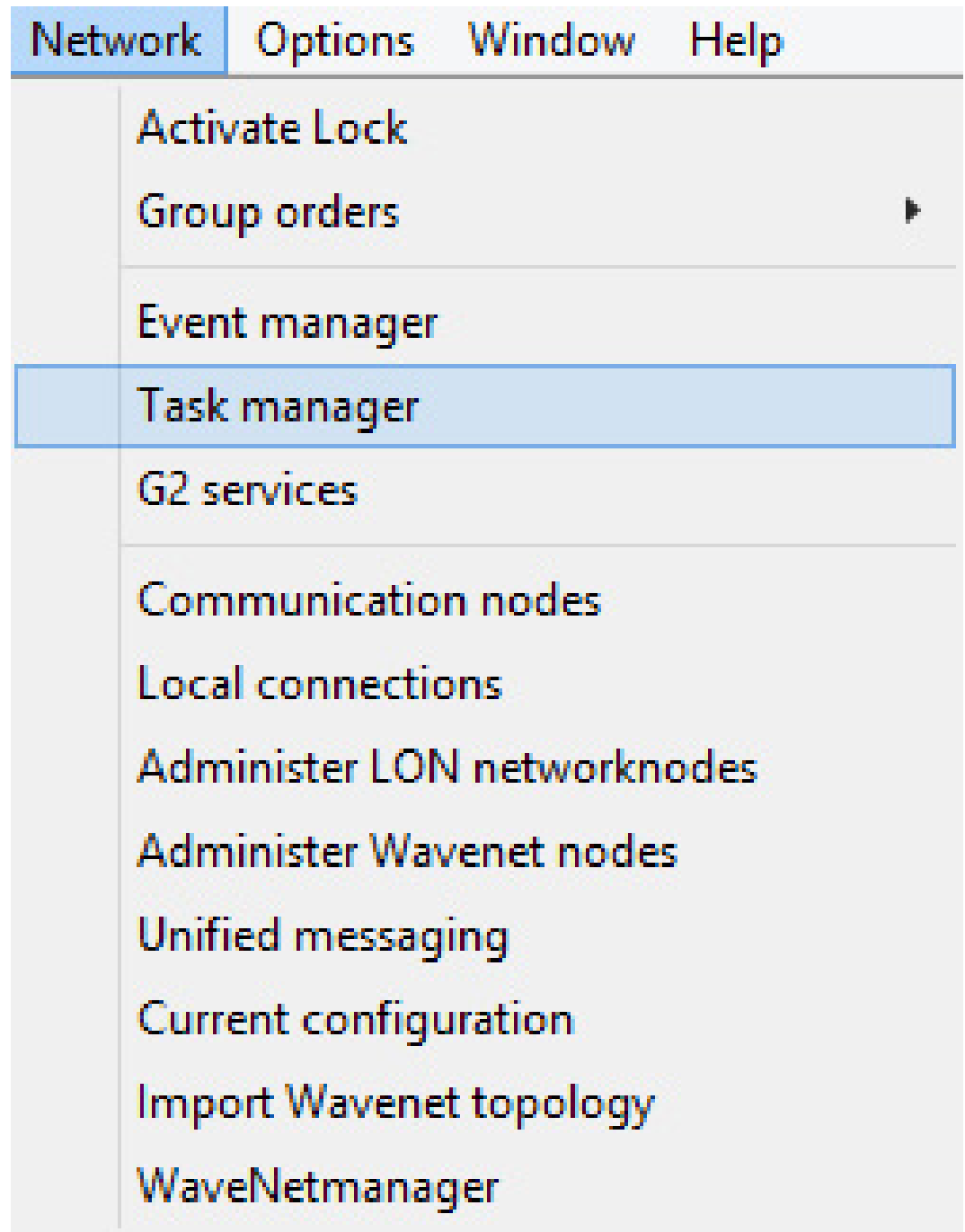

1. Launch Task Manager by selecting 'Network' » 'Task manager'

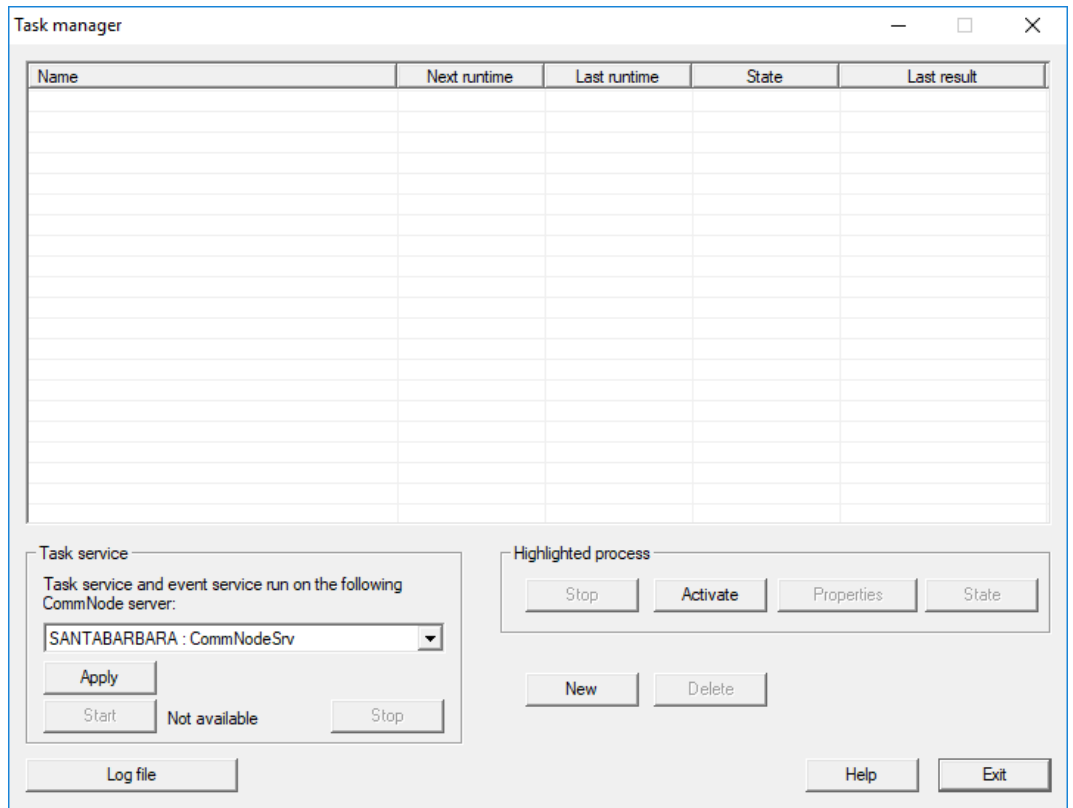

2. Create a task by clicking on [New]

Task

Name: DM Configuration

Description:

Type: Configure door monitoring

Status:

Activated (start planned task as stated)

Execute

Once

Repetition interval

As reaction to an event

Start time: 13:16

Start date: 07 August 2014

Repetition interval:

All 2 Minutes

Locks/network nodes

Edit Display status

OK Options Cancel

3. Assign a name to the tasks
4. Select the type of task, e.g. 'Configure DoorMonitoring'

5. Set the repeat interval

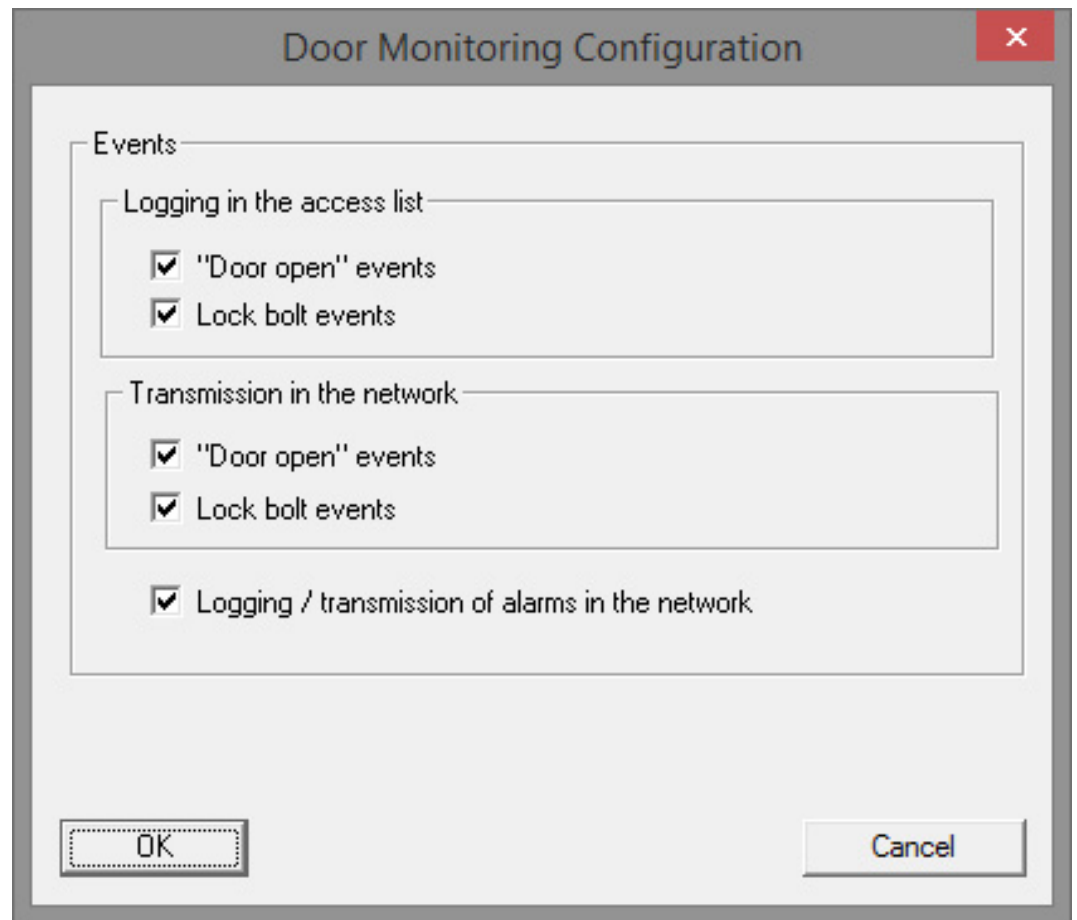

6. Click on [Options] for other settings

- ↳ Logging 'Door open' events
- ↳ Logging of dead bolt events
- ↳ Forwarding of 'Door open' events
- ↳ Forwarding of dead bolt events
- ↳ Event logging/forwarding of alarms in the network

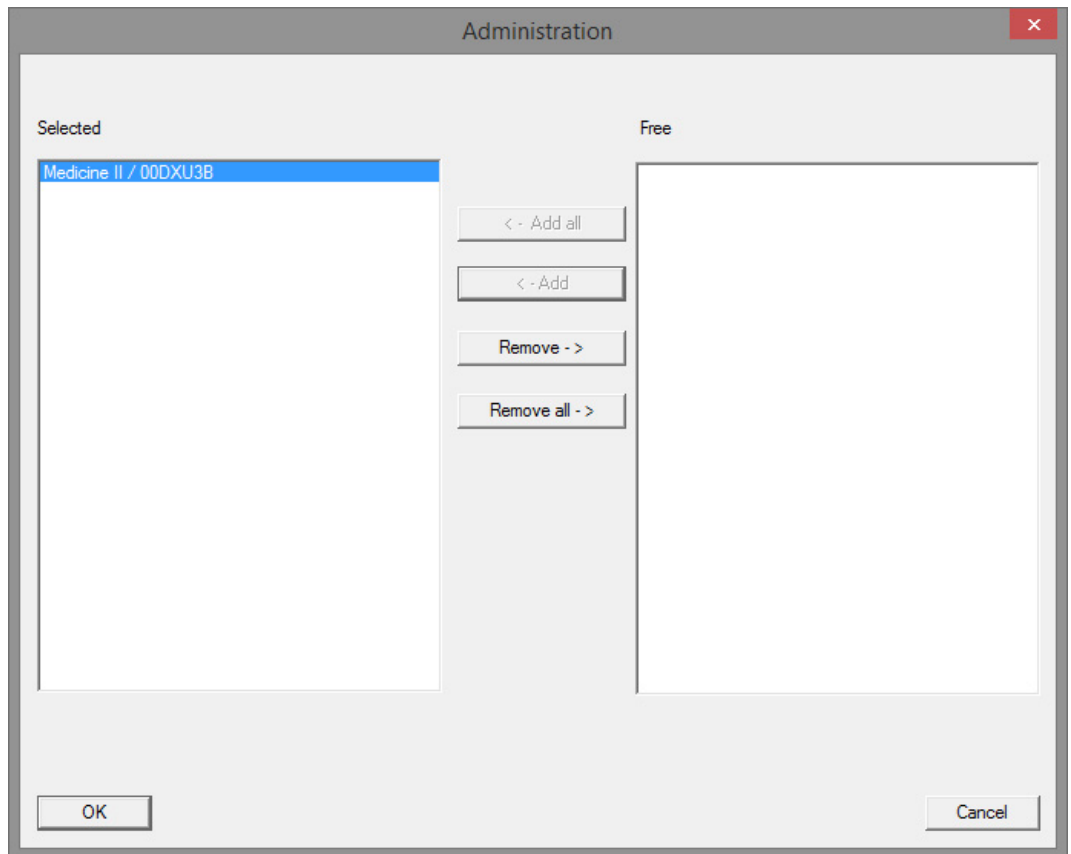

7. Click on [Edit] in the 'Locking devices/network nodes' section
 - ↳ Door administration will open. This is where you select the doors for the task
8. Click on [OK] to exit the task menu
9. Click on [Finish] to exit Task Manager
10. Confirm the prompt by pressing 'Yes' if the configuration is to be forwarded directly
11. Acknowledge the prompt by pressing 'No' if you would like to forward the configuration manually at a later stage using the 'Communication node' menu
 - ↳ The task has been set up completely

5.3.2.3 Events

Events in the network are linked to one or more targeted responses in Event Manager. The LSM software can trigger a pre-set response to certain events, such as an open door. Responses include a pop-up message on a computer in the network, activation of an alarm siren and an email sent to the security officer's mobile 'phone. You can enter the day of the week and time to determine the time period within which a response is to be given to an event.

Special events have been created for the DoorMonitoring Cylinder. This section gives a short overview of Event Manager and events. You can find more information in the 'LSM – online' manual

- ✓ LSM Business or Professional
- ✓ Locking device network connection
- ✓ Online module licensed

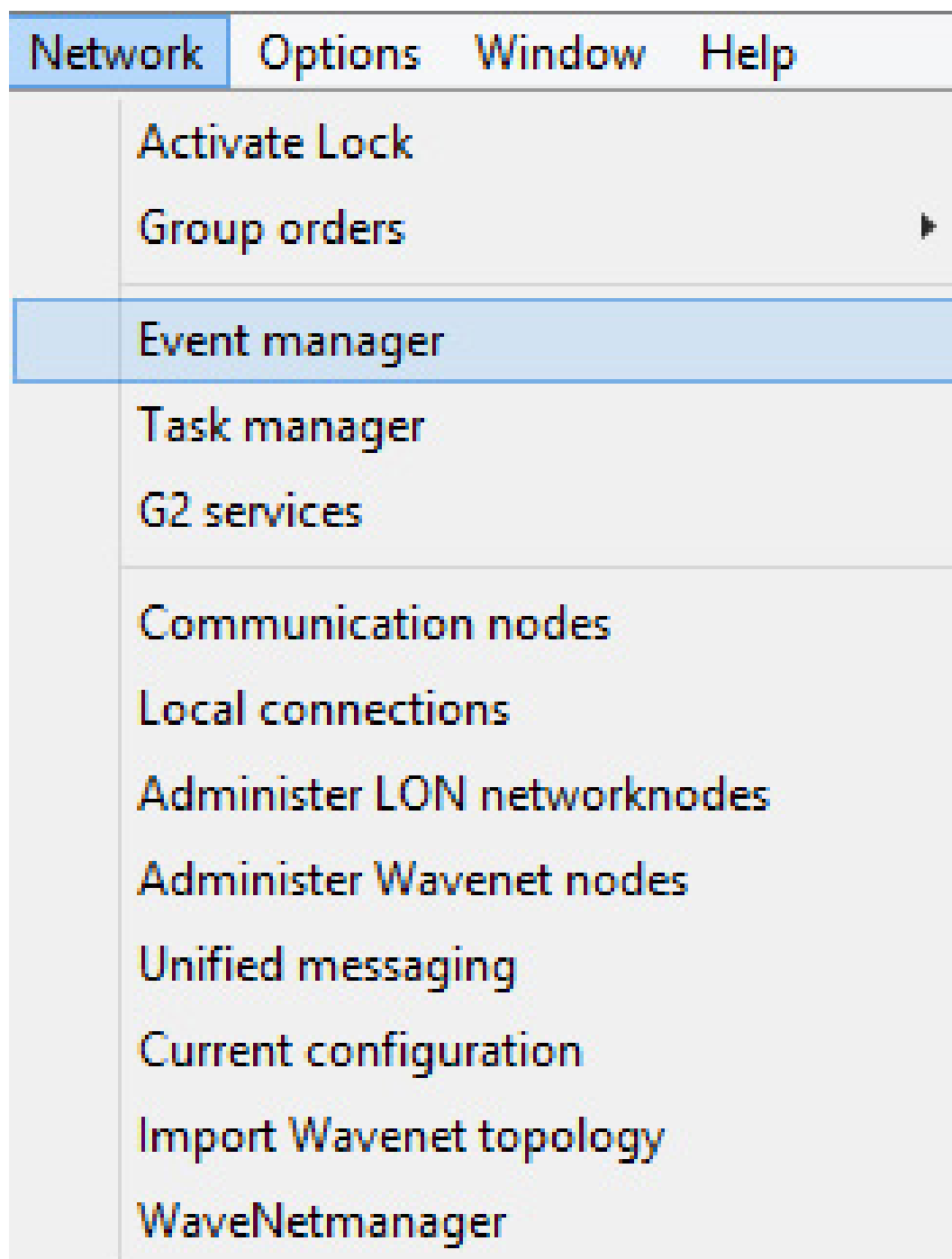

1. Click on 'Network' » 'Event manager' to open event manager

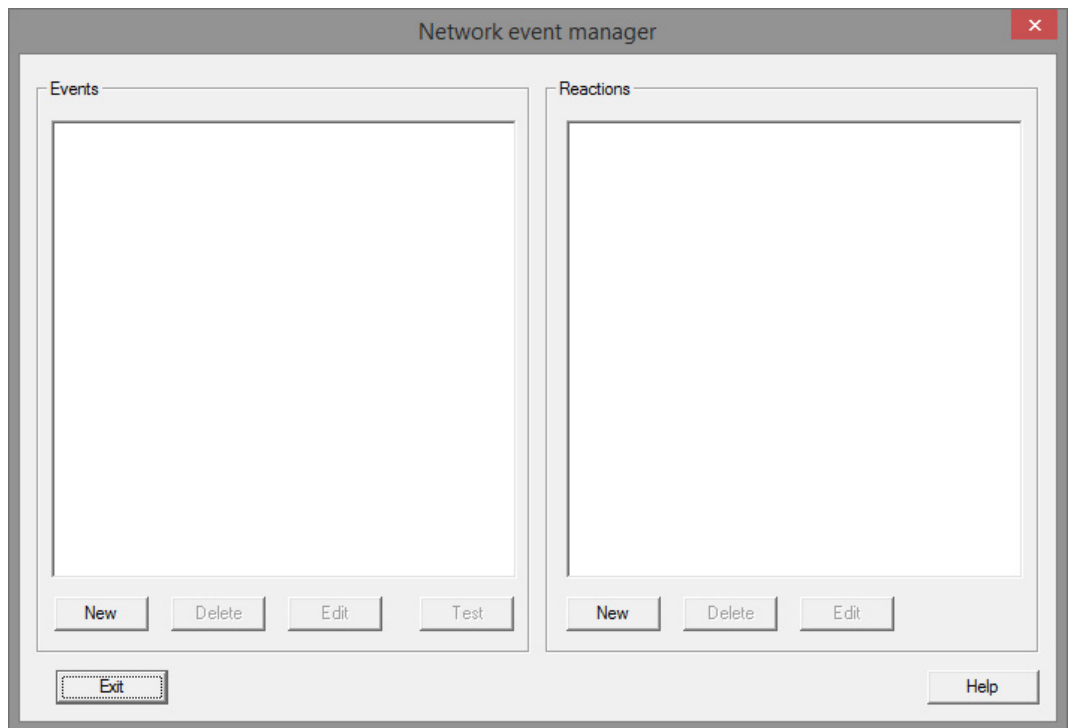

2. Click on [New] to create an event

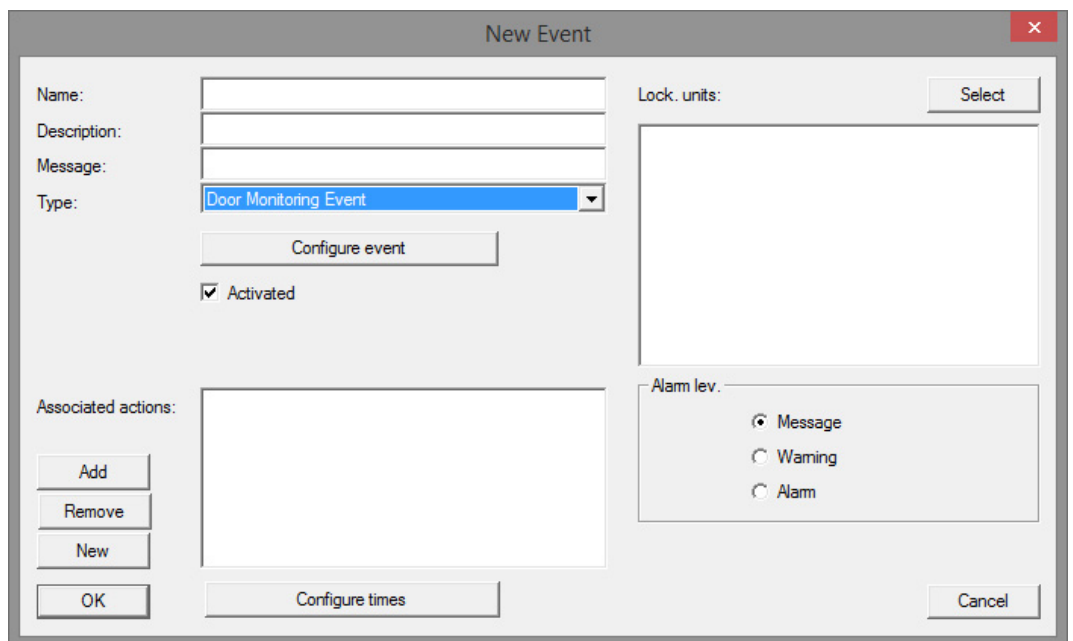

3. Select 'DoorMonitoring event' as the type and assign a name for the event

4. Click on [Configure event]

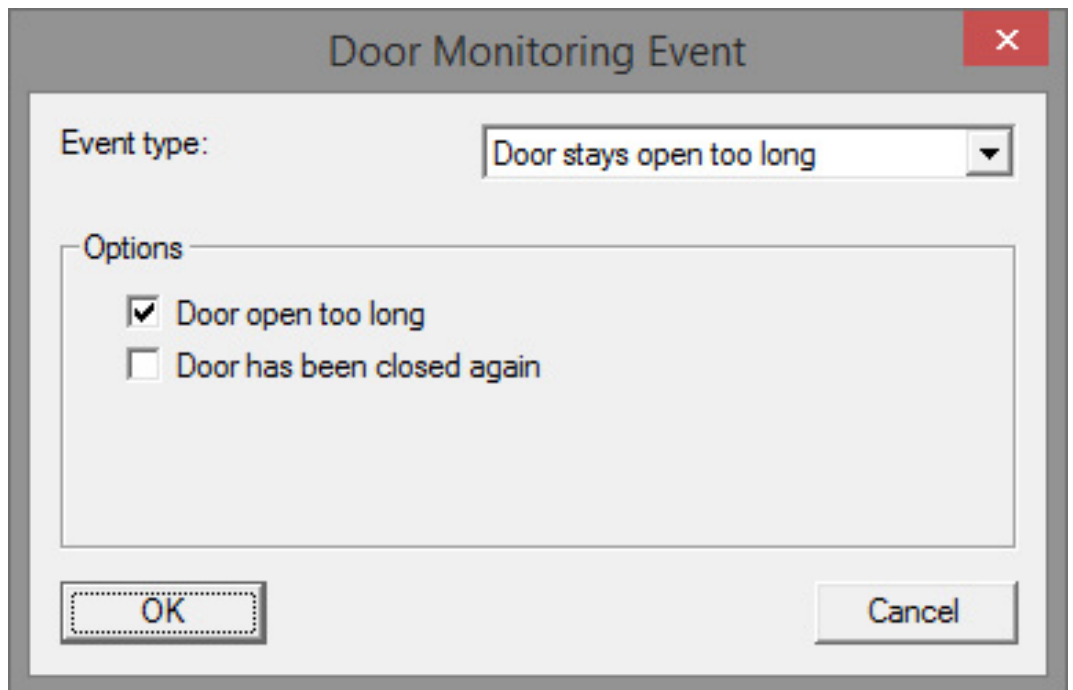

5. Select the event type and required option
- Door status | Options: 'Door open' / 'Door closed'
 - Dead bolt movement | Options: 'Door not locked' / 'Door locked' / 'Door securely locked'
 - Door stays open too long | Options: 'Door open too long' / 'Door locked'

again'

- Manipulation attempt
- Hardware error

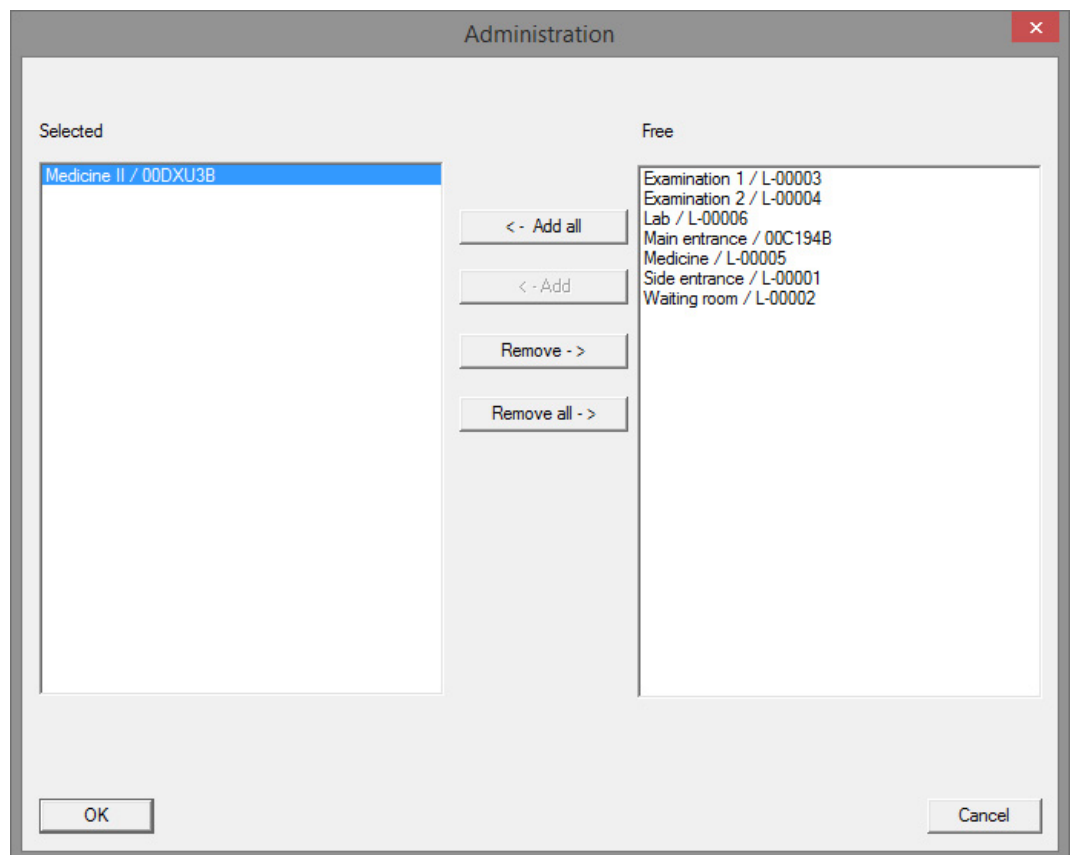

6. Click on [Select] in 'Locking devices'

7. Add the locking devices for the event

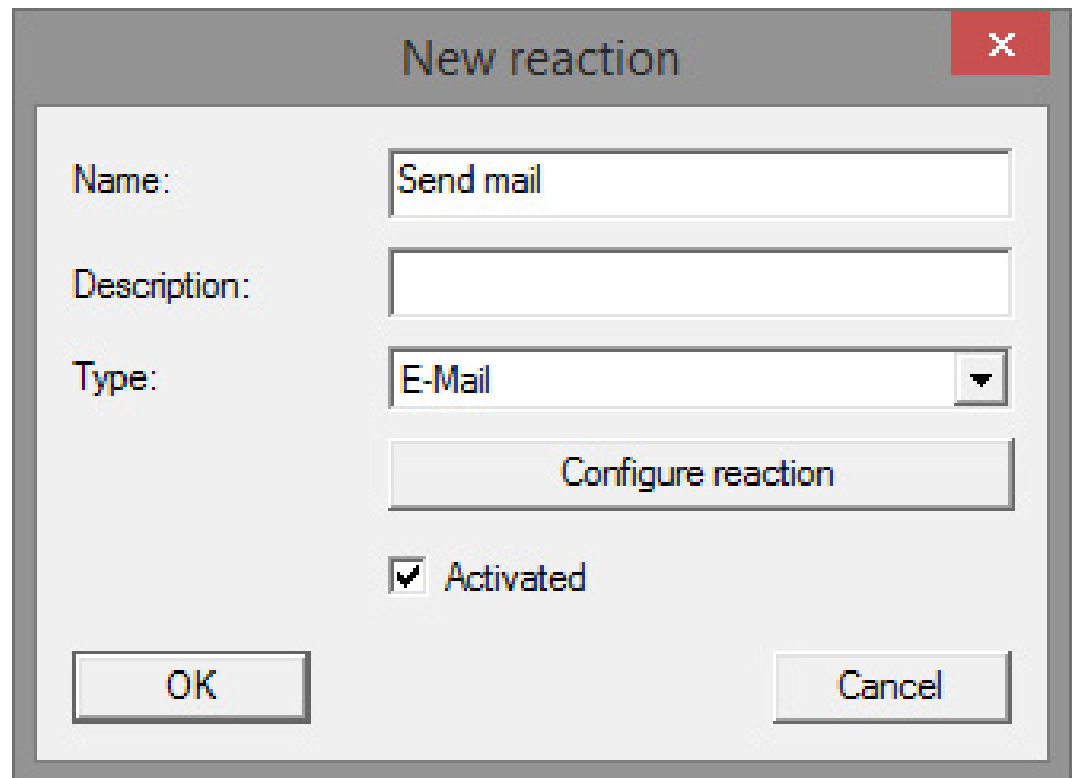

The screenshot shows a 'New reaction' dialog box. The title bar contains the text 'New reaction' and a red close button with a white 'X'. The dialog has a light gray background. It contains the following elements:

- Name:** A text input field containing the text 'Send mail'.
- Description:** An empty text input field.
- Type:** A dropdown menu with 'E-Mail' selected and a downward arrow on the right.
- Configure reaction:** A button with the text 'Configure reaction'.
- Activated:** A checked checkbox followed by the text 'Activated'.
- OK:** A button with the text 'OK'.
- Cancel:** A button with the text 'Cancel'.

8. Create a response to the event. Click on [New]
9. Select the type of response time and assign a name
 - Execute file: A program is started, such as batch file
 - Email: forwarding of a pre-defined email to a specific recipient group
 - Network task: this is where you can carry out a specific task over the SimonsVoss network, e.g. remote opening
 - Network message: forwarding of a message to a predetermined network computer over the IT network
 - Log file: the event is recorded in a log file for subsequent analysis
10. Click on [Configure response] to set up a response
11. Click on [Configure time] to set the time period for the event
12. Exit the set-up wizard and accept the prompt by pressing 'Yes'
 - ↳ The event is now fully configured

5.3.3 Access list

You can configure the number of accesses which are forwarded to LSM from a locking device's access list. As every status change which the DM Cylinder logs is saved as a dataset in the access list, it is best to select the setting in accordance with typical requirements.

The settings apply to all .ZK locking devices



NOTE

Power consumption rises as the amount of data read increases

The greater the amount of data transmitted is, the longer the read process takes

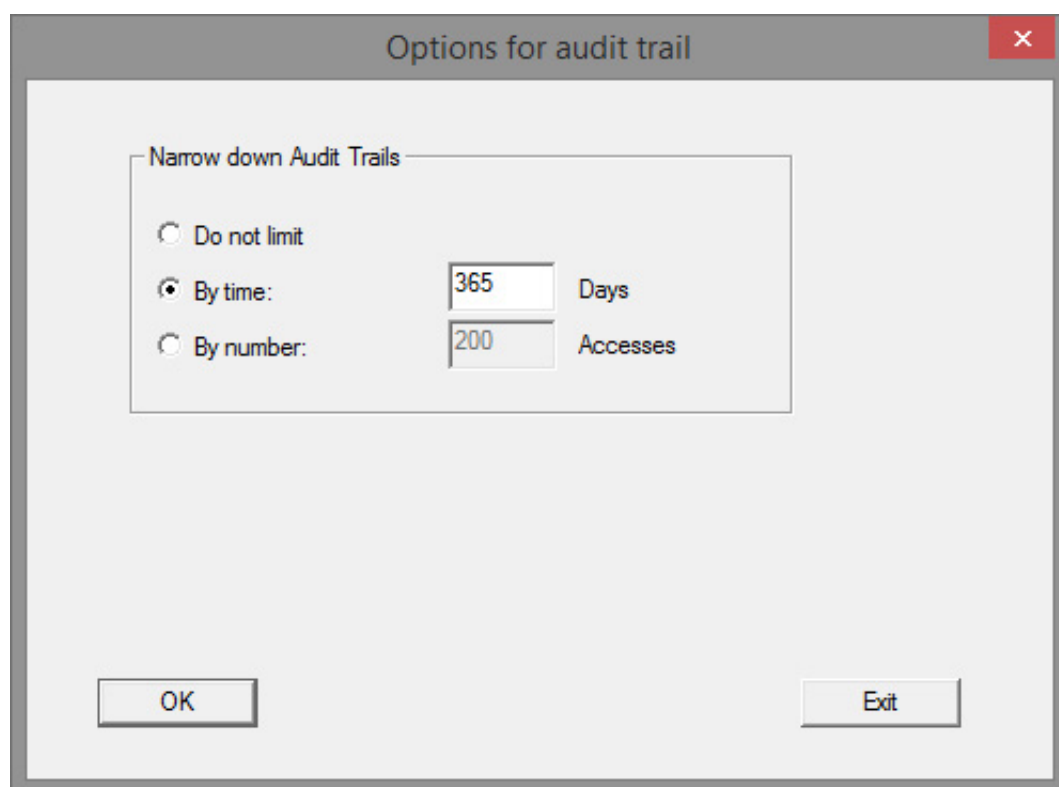
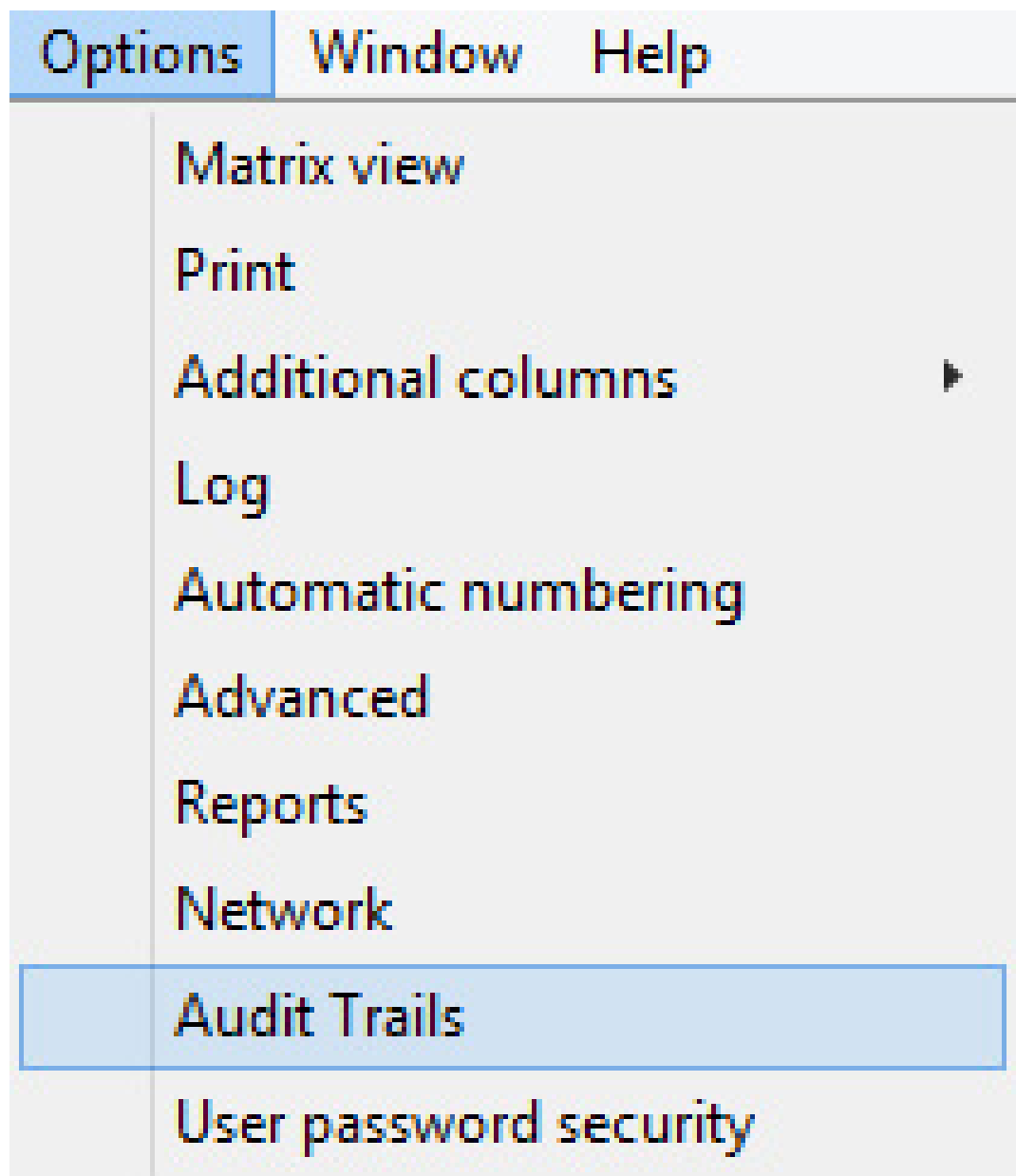

Fig. 13: Access list



1. Click on [Options] in the menu
2. Select [Access list]
3. Configure access list transmission:
 - Unrestricted
 - Time-restricted
 - Restricted by number

5.4 Installation and fitting

Installation instructions

The DM Cylinder is installed in the same way as any other SimonsVoss digital cylinder

Batteries are already installed when the product is delivered. The cylinder is ready for immediate use

When installing the digital locking cylinder, ensure that there are no sources of low-frequency interference in the surrounding area. Typical sources are:

- Switch-mode power supply units
- High-voltage power lines
- Generators
- Frequency converters

Locking cylinders should be installed at least 0.5 m from one another while SmartRelays or activation units should be 1.5 m from one another

The locking cylinder housing may only project a maximum of 3 mm from the door in outdoor areas; a profile cylinder escutcheon or fitting should be used if necessary

You must not strike the thumb-turns when installing the cylinder



NOTE

The DoorMonitoring Cylinder must not be fitted with conventional fastening screws

Conventional fastening screws may permanently damage the cylinder

1. The DM Cylinder must be fitted with a fastening screw especially manufactured for the cylinder
2. The fastening screw is not included in the supply package and must be ordered separately

The standard fastening screw is available for a backset between 25 mm and 110 mm at 5 mm increments. You must indicate the lock backset when you order. If you use a fastening screw which is too short, the screw will not be able to provide a firm grip; if you use one which is too long, you cannot screw it fully within the door leaf

The head of the fixing screw features a sensor. The screw is tightened using a special screwdriver or adapter. If a conventional slot screwdriver is used, it could permanently damage the screw and the sensor

Lock standards specify that the hole diameter for the fastening screw must be at least 5.4mm. Some locks are supplied with a smaller drill hole. If this is the case, you can make it larger with a 5.5-mm steel drill bit

Installation

There is a thumb-turn with electronics and a thumb-turn without electronics in digital locking cylinders. The thumb-turn electronics must be removed for installation. The electronics thumb-turn is on the inside for almost all cylinders. The few exceptions are:

- Comfort Cylinder: .CO

■ Swiss Round Cylinder: .SR

The word 'IN' is engraved on the cylinder body on inside of the cylinder

The thumb-turn without electronics is merely attached in position when delivered and can be easily removed

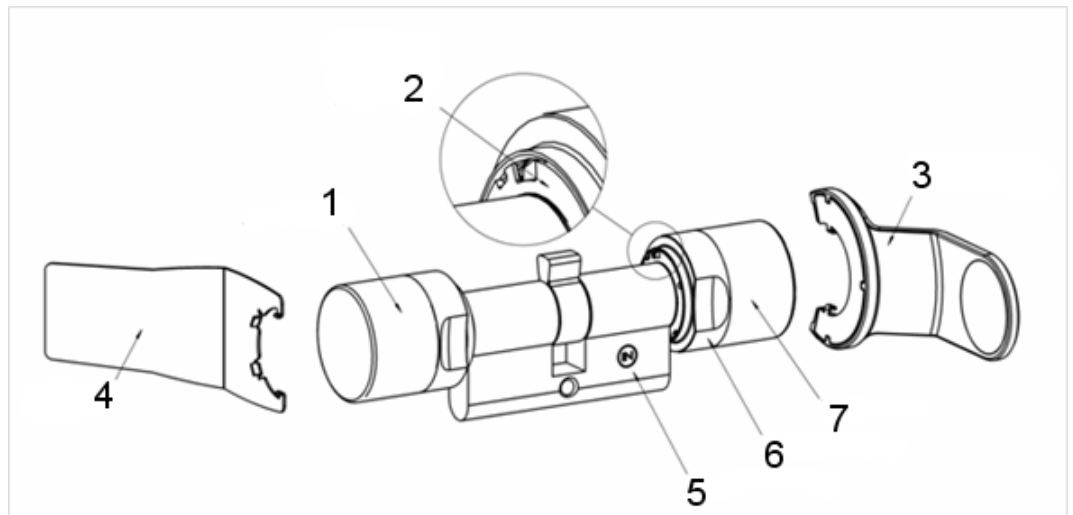

1. Outside thumb-turn (without electronics)
2. Locking disc with opening
3. Installation and battery key
4. Installation key (not for battery replacement)
5. Side marking
6. Recessed grip ring
7. Inside thumb-turn (with electronics)

1. Remove the thumb-turn without electronics
2. Insert the cylinder through the lock

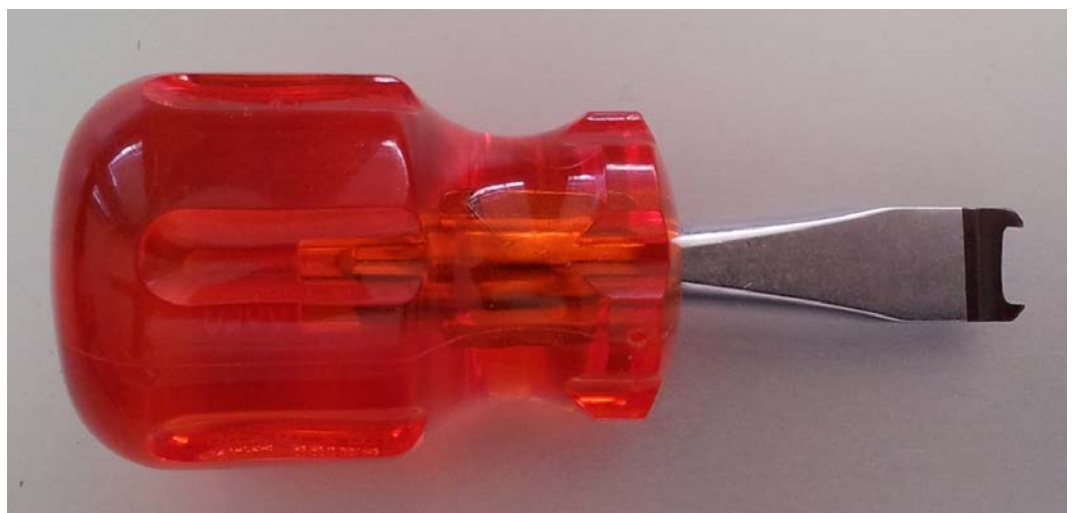

3. Fasten the cylinder with the appropriate fastening screw. Do not fasten screw tightly. Use the correct screwdriver only



NOTE

If you tighten the fastening screw too firmly, this may cause the locking cylinder to malfunction in the lock (e.g. it may jam).

Tighten the fastening screw firmly by hand (max. 3.5 Nm)

Do not use a battery-operated screwdriver



NOTE

A conventional screwdriver can damage the sensor in the fastening screw

Tighten the fastening screw with the appropriate screwdriver only

4. Replace the thumb-turn and rotate until the thumb-turn grips into the indents in the flange
5. Place the installation key on the outer thumb-turn in such a way that the two teeth lock into the outer thumb-turn; if necessary, turn the thumb-turn until both teeth engage into the locking disc
6. Lock the thumb-turn into position again by rotating it 30° in a clockwise direction

5.4.1 Magnet installation

The sensor in the fastening screw works magnetically. Therefore you have to glue the magnetic plates, which are attached to the fastening screw, into the door frame. Then perform a function test.

One or more magnetic plates need to be glued on, depending on the door and frame material and the gap width



NOTE

Overdrive of the sensor

If you mount too many plates, the magnetic field becomes too strong. The sensor in the fastening screw is then overridden and no longer responds.



NOTE

Lack of adhesive strength due to unsuitable support surface

Dust, dirt and grease reduce the adhesive strength of the magnetic plate. The magnetic plate may fall down and cause malfunction.

- Make sure that the surface is clean and free of grease before applying magnetic plates.

1. Glue the magnetic plates loosely into the door frame so that the plates are opposite the head of the fastening screw.
2. Close the door carefully so that the latch almost clicks into place.
3. If the display in the LSM jumps from "open" to "closed" when the door is almost closed:
 - Reduce the number of magnetic plates.
 - Move the plate further in the direction of the centre of the frame.
 - Reduce the size of the plate.
4. Close the door.
 - ↳ The indicator in LSM must change from 'open' to 'closed.' If this not the case, the magnetic field is too weak for the sensor. Stick an additional plate on the door frame and repeat the test.

5.4.2 Functions test

The functions test verifies that the complete communication chain from the sensors to LSM function correctly

The following tests need to be performed

- ✓ The locking plan is open
 - ✓ The DM cylinder is incorporated into the SimonsVoss network (WaveNet)
 - ✓ The DoorMonitoring status is displayed in the locking plan
 - or -
 - ✓ The properties in the cylinder 'Door monitoring status' tab are open
 - ✓ The individual test results can be checked in LSM
1. Opening the door
 2. Closing the door
 3. Rotate the cam bit once » lock. Repeat until the bolt is fully extended, depending on the number of turns required in the lock
 4. Rotate the cam bit once » open. Repeat until the bolt is fully withdrawn, depending on the number of turns required in the lock
 5. Opening the door
 6. Leave the door open until the 'Door open too long' message appears

Calibration tool

This offline cylinder test is carried out with a separate calibration tool if the DoorMonitoring cylinder is set up or operated offline or the test is part of an error search if statuses are incorrectly displayed or are not displayed at all during an online test.

We recommend the calibration tool if

- The DoorMonitoring Cylinder is not networked. In such a case, you can check status changes with the tool
- The DoorMonitoring Cylinder is being set up by one person. In such a case, status changes cannot be checked directly in LSM
- The functioning of the DoorMonitoring Cylinder is to be checked for error diagnosis

The calibration tool is installed on an external portable computer and connected to LSM Mobile. A programming device connected to the computer is required

Installing the calibration tool

Install the calibration tool on a portable computer, so that the cylinder can be checked on the door

Insert the LSM software CD and launch the installation routine (DMCalibrate_3_x_xx.exe)

Follow the instructions in the installation wizard

Exporting configuration

- ✓ A DoorMonitoring Cylinder has been added to the locking plan and programmed
- ✓ The calibration tool is installed on an external portable computer
- ✓ A SmartCD.G2 programming device is connected

1. Launch the 'DM Calibrate' software

2. The DoorMonitoring Cylinder configuration data is exported in the same way as to LSM Mobile

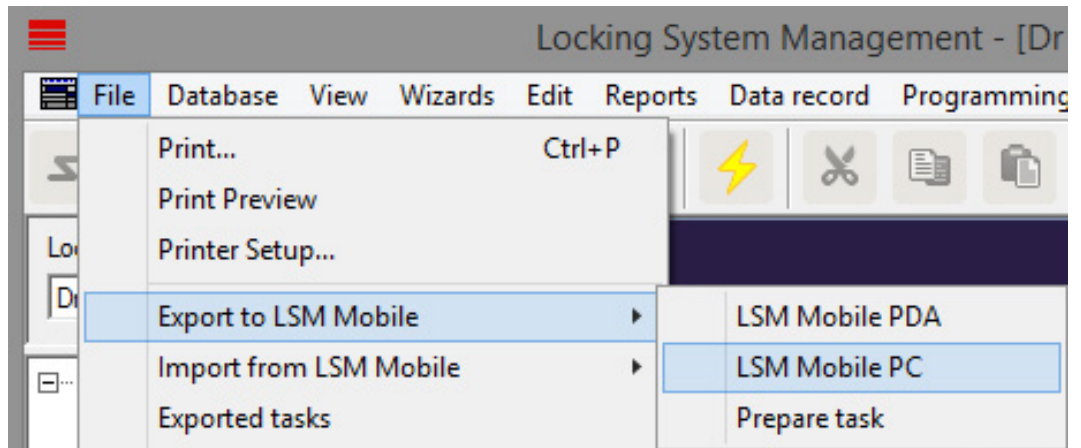

3. Click on 'File' in the menu
4. Select 'Export to LSM Mobile' » 'LSM Mobile PC'

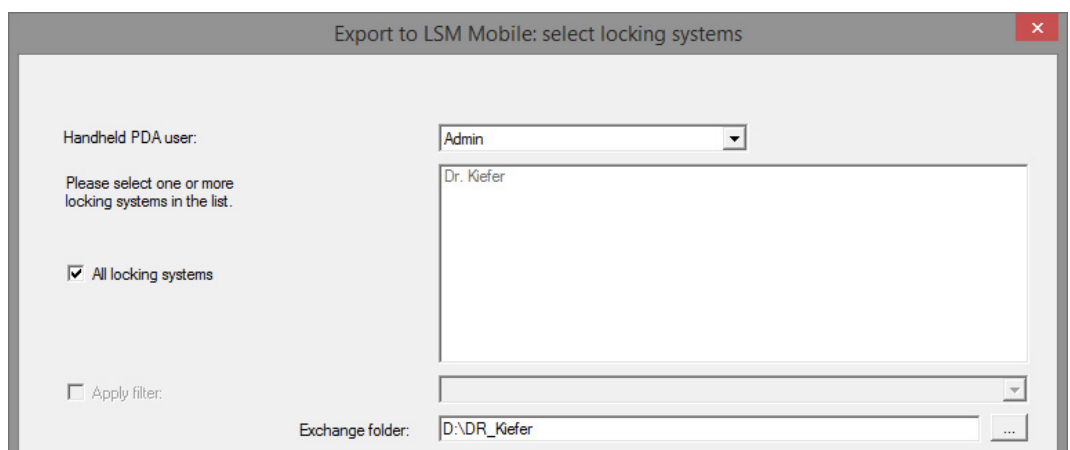

5. Select the locking system
6. Indicate the folder where the programming tasks are to be saved

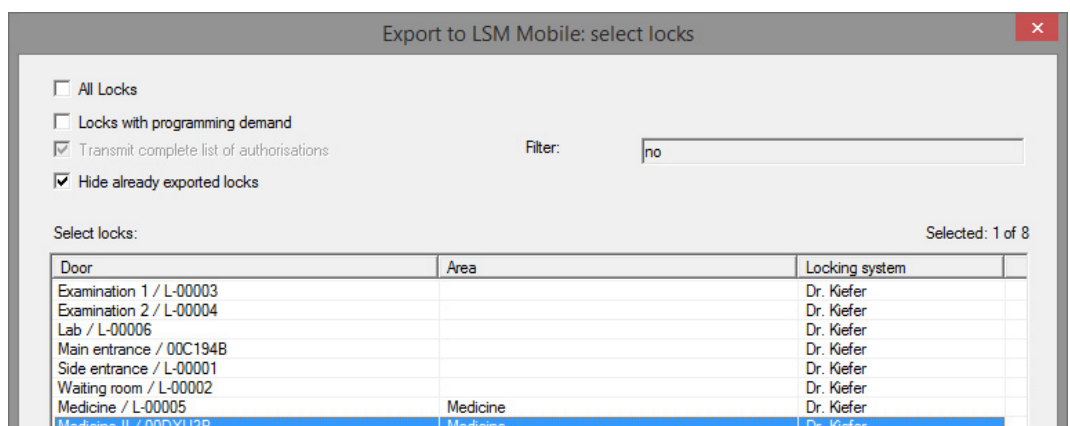

7. Highlight the locking devices which are to be exported

Export to LSM Mobile: select tasks

Selected: 1 of 1

Locks	Sync	Task	Allowed	Expiry date	Number
Medicine II/00DXU3B	no	PLZ	PLZOR	Thu, 21.08.14 15:39	1
Unknown lock			RO	Thu, 21.08.14 15:39	1

Tasks

- (P) Programming
- (T) Read transponder list
- (L) Read Audit Trail
- (Z) Set clock

Settings

Maximum no. of executions:

Perform until:

Password for emergency unlocking:

Allowed

- (P) Programming
- (T) Read transponder list
- (L) Read Audit Trail
- (Z) Set clock
- (O) Open door
- (R) Reset
- (A) Modify transponder
- (I) Modify current data

Default settings

< Back

8. Highlight the permitted actions and tasks
9. Highlight the locking devices and increase the 'Maximum number of executions.' A number between 1 and 10 is possible
10. Carry out the next steps
11. Once the tasks have been saved, copy the folder to the portable computer
12. Connect the SmartCD to the portable computer

13. Launch the 'DM Calibrate' program on the portable computer

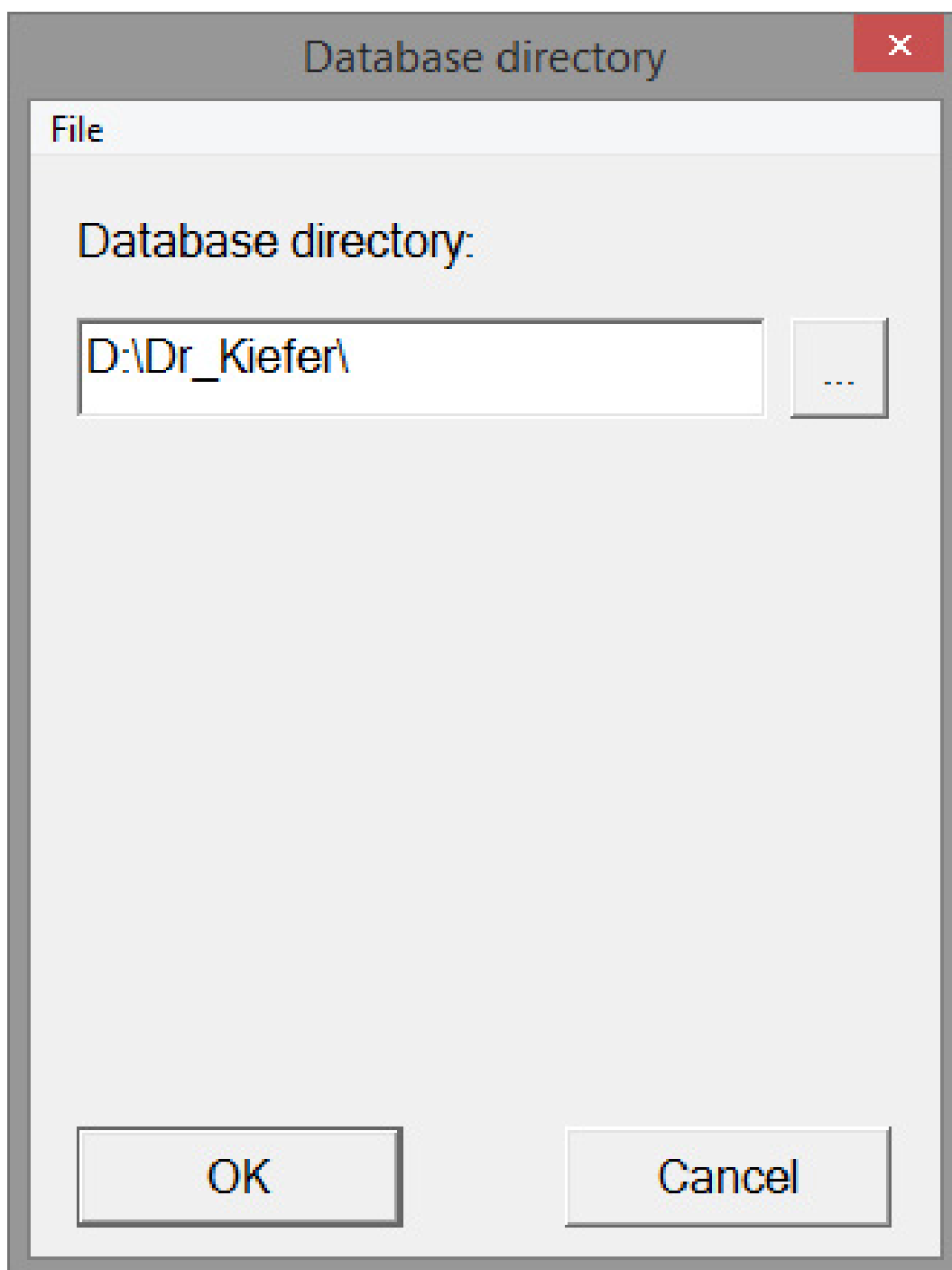

14. Select the folder with the programming tasks

The image shows a 'Logon' dialog box with a red close button in the top right corner. The dialog contains the following elements:

- File**: A menu bar at the top.
- LOG ON**: A section header.
- Database:** A dropdown menu showing 'Dr Kiefer BU'.
- User:** A text input field containing 'Admin'.
- Password:** An empty text input field.
- Exported on:** A text input field containing '15:20 09.10.2014'.
- Buttons:** 'OK', 'Cancel', and 'Remove' buttons are located at the bottom of the dialog.

15. Log on using the database password

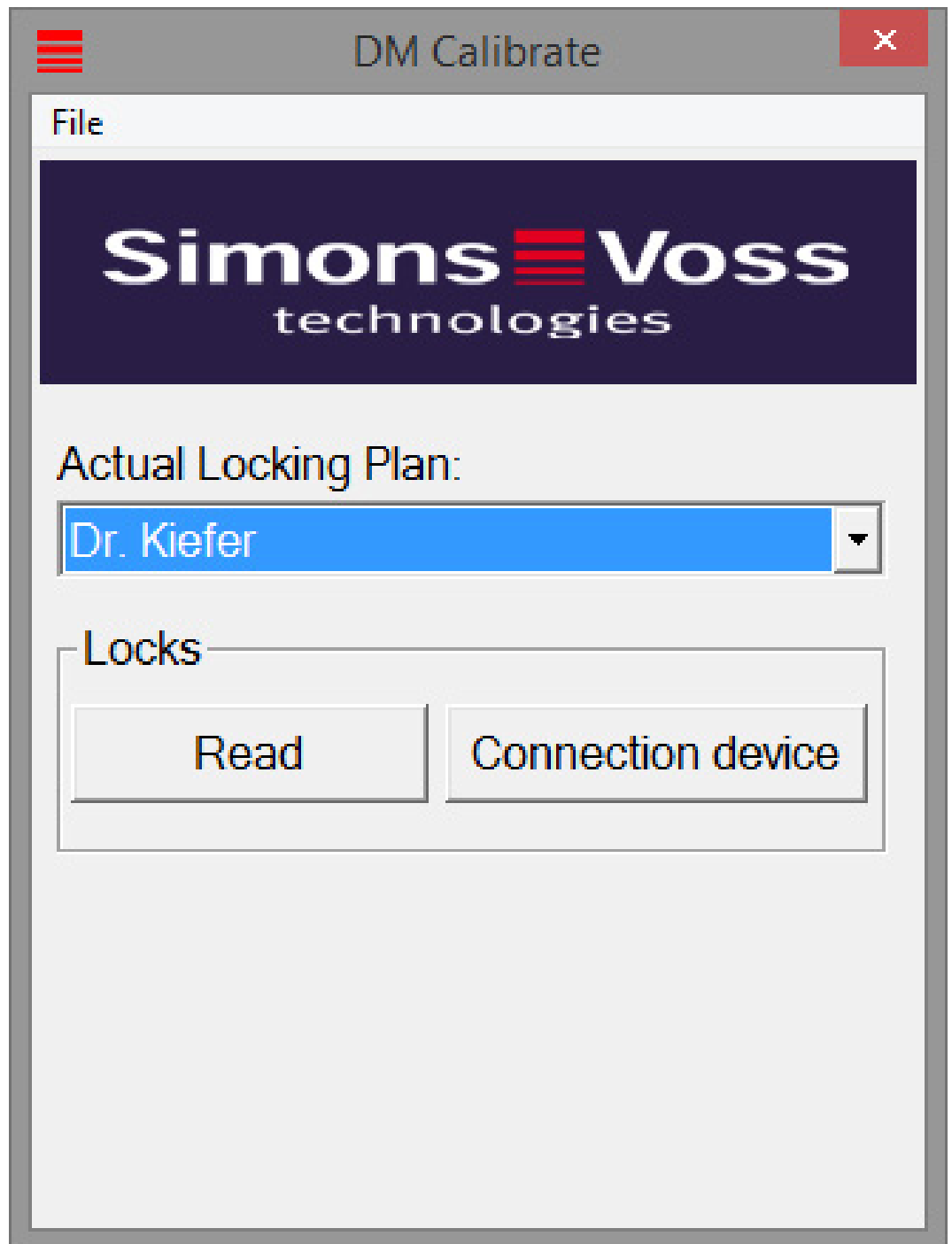

16. Click on [Attached device]

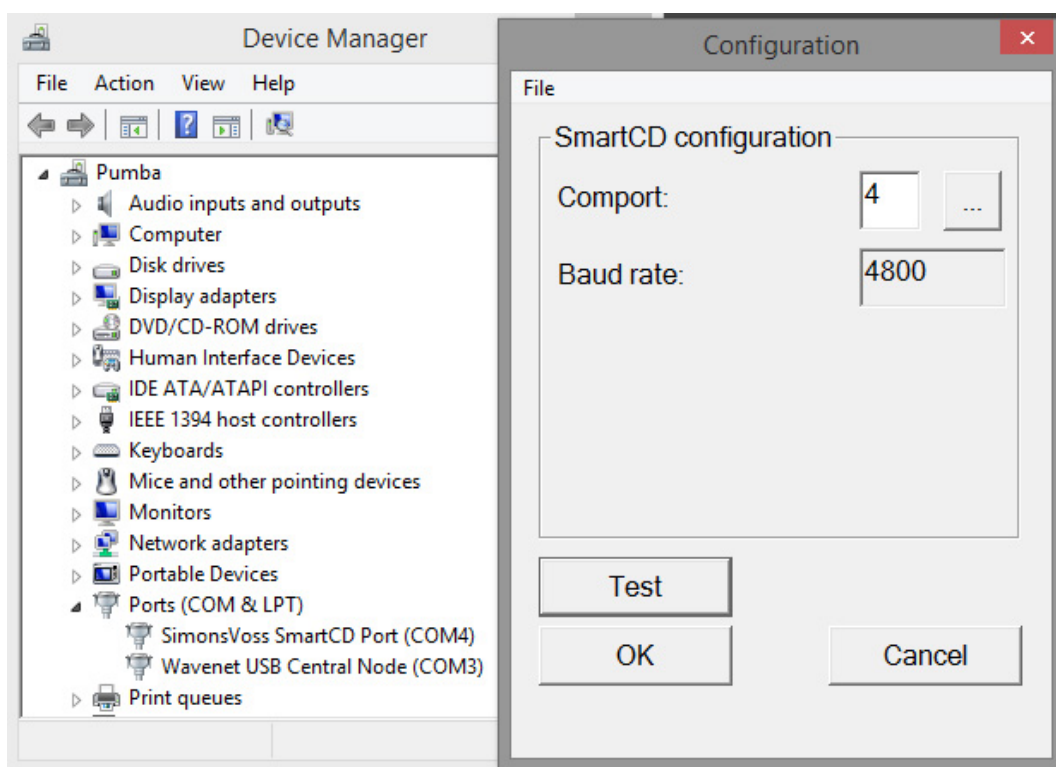

17. Enter the COM port

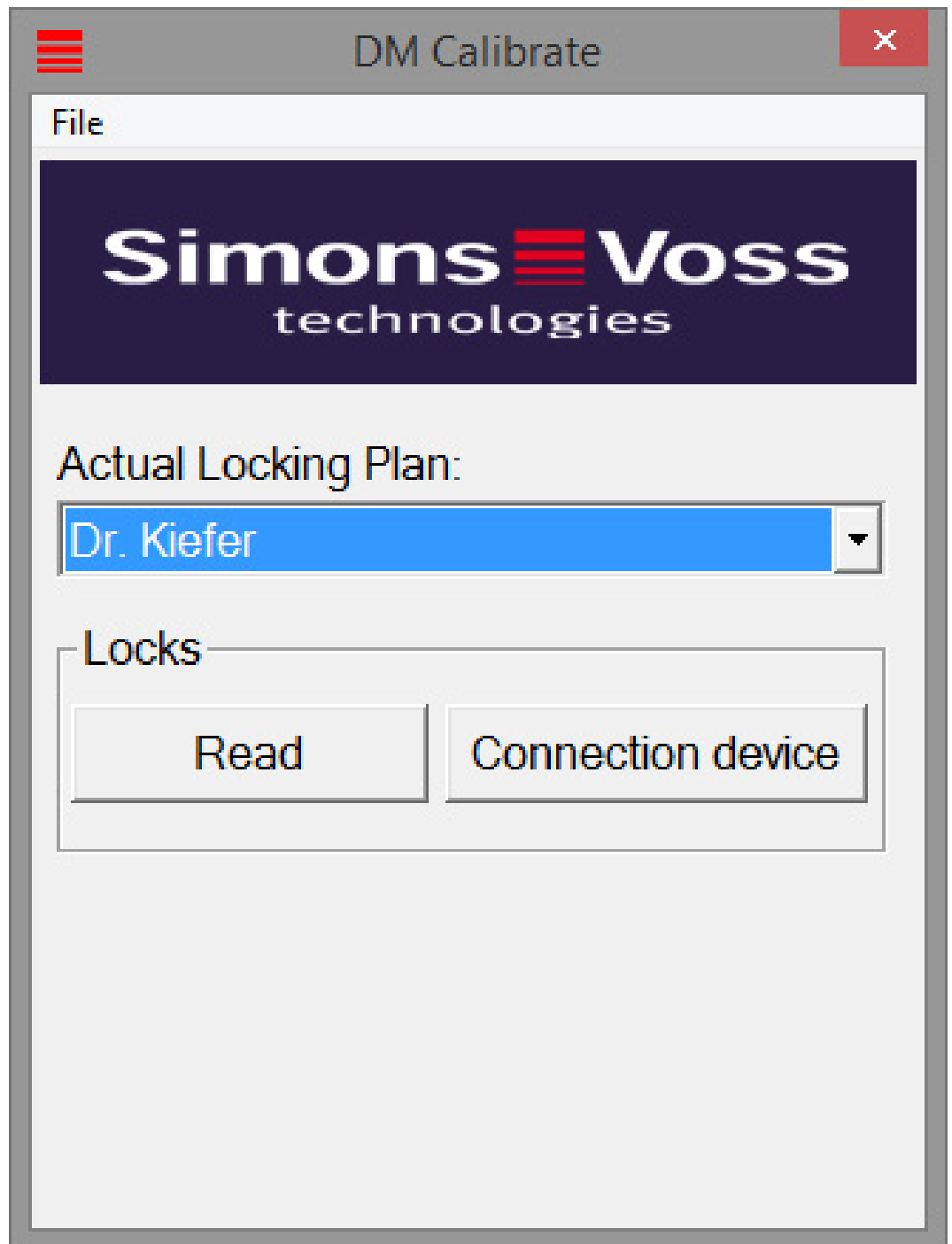

18. Click on [Upload]

↳ The menu will appear with the calibration steps

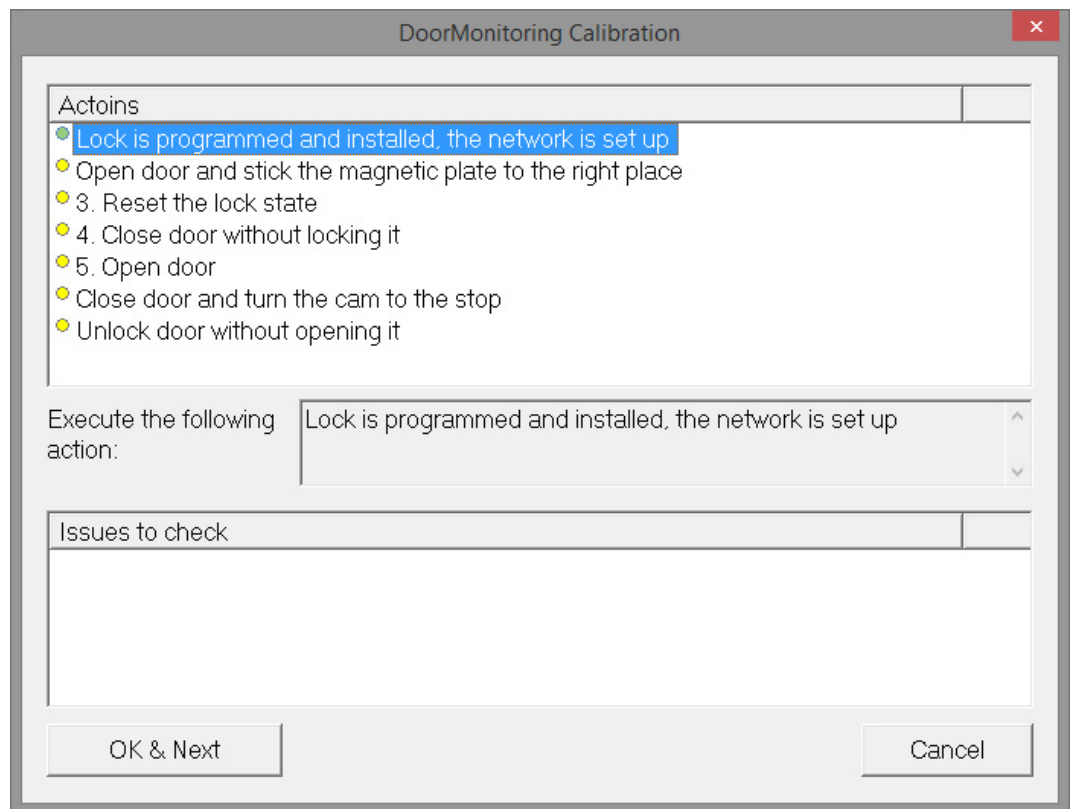

19. Follow the instructions and confirm by pressing [OK & Next]

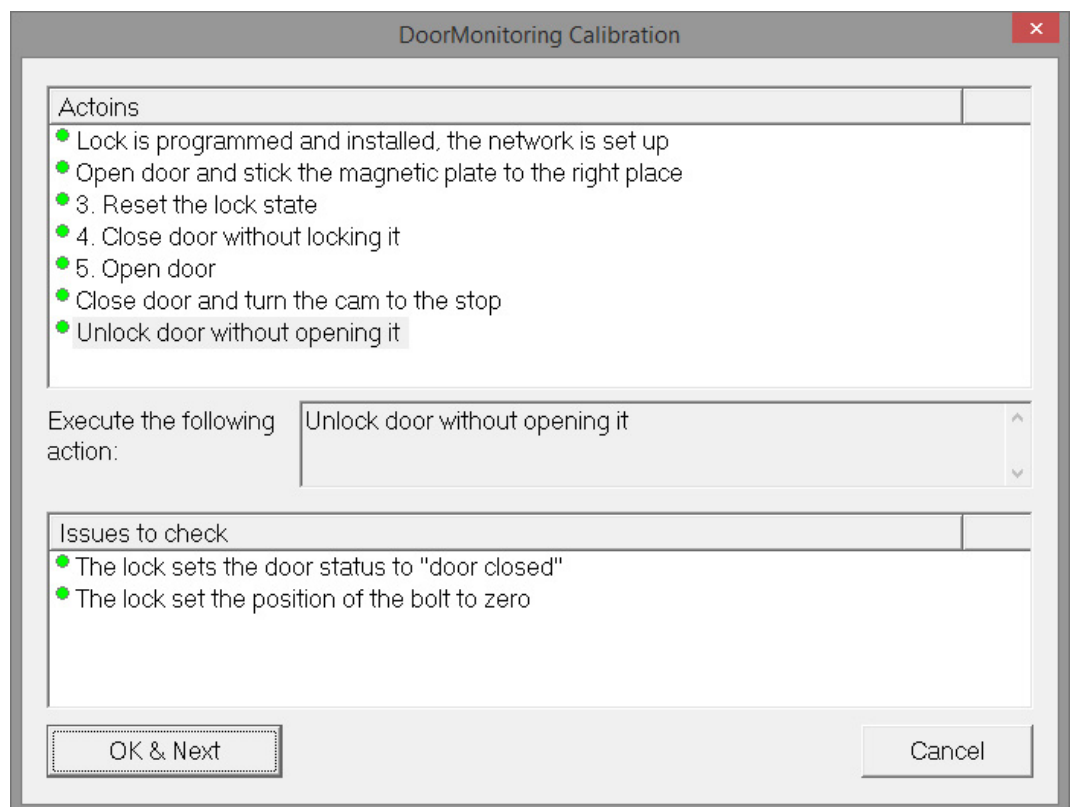

20. As soon as all actions are complete, exit DoorMonitoring calibration

21. Copy the files back onto the computer where the locking plan is located

22. Import the tasks via File » Import from LSM Mobile » LSM Mobile PC

Calibration tasks

There are seven designated steps for calibration

Steps to be carried out	Explanation
1. Locking device is programmed and installed. Network is installed	Confirm that these tasks have been completed. Network is not absolutely necessary if the cylinder is operated offline.
2. Open door and affix the magnetic strip to the correct position	Confirm after the magnetic plate has been attached to the striking plate opposite the fastening screw. Affix the plate loosely first, so that it can be moved if necessary
3. Close door but do not lock	Carry out step and confirm. The cylinder is read after confirmation
4. Open the door	Open the door. The cylinder is read after confirmation
5. The locking device's bolt position is initialised	Confirm. The cylinder is read and initialised after confirmation
6. Close door and lock fully	Lock door. After confirmation, the cylinder is scanned and the number of cam rotations until the door is securely locked is detected. The user is asked if the number of rotations is to be entered
7. Unlock door without opening it	Unlock door. The cylinder is read after confirmation

A traffic-light-style indicator displays the status in addition to the individual step:

- Yellow: step not yet implemented
- Green: step complete and positive feedback
- Red: indicates an error. Either the step has not been followed or an error has been detected



NOTE

Note on anti-panic cylinder: There is no monitoring of bolt movement in the DM.AP2 Cylinder. This is why you need to carry out Steps 1 to 4 when checking the DM.AP2 Cylinder. You can skip the other steps. Press [OK & Next] and ignore comments.

Check magnet position

If the door has been closed, but the calibration tool does not recognise that the door is closed (Step 3), the position of the magnetic plate needs to be checked or the number of magnetic plates needs to be increased.

Step 4 should also be performed on the door while ajar. If the door is identified as closed when it is ajar after Step 4, the magnetic field is too strong.

Move the plate further towards the centre of the frame or make the plate smaller

5.4.3 Use in escape doors

Use in an escape door lock

Panic locks can be unlocked and opened from the inside by pushing the door handle. The lock unlocks without the cam rotating. Some locks require an anti-panic cylinder since the cam can cause the lock to jam when in certain positions. You need to clarify with the lock manufacturer whether an AP cylinder must be used or not. Different issues need to be clarified in advance when the DM Cylinder is used in escape door locks:

- SLP lock or non-SLP lock
- Use of an AP cylinder required to prevent the lock from jamming
- Typical usage behaviour of the door.

Is the door normally opened with an authorised transponder or by pressing the inside handle? The DM Cylinder records the cam's movements and detects the lock status based on rotations and the direction of rotation. It does not record retraction of the bolt and, consequently, does not register the unlocking of the door either. Cam monitoring is deactivated in the DM.AP2 Cylinder. Manual locking is not monitored.



NOTE

You must comply with the requirements in DIN EN 179 or EN 1125 when fitting an escape door lock.

Use in an SLP lock

An SLP (self-locking panic) lock can be opened on the inside by pressing the door fitting and locked when the door is closed. This means that the DM Cylinder does not reliably indicate the bolt position (at all). The DM.AP2 does not monitor the bolt position. This means that only the door's opening status can be monitored. The following setting should be configured.

Target

Door open settings

Read interval for the fastening screw: 2 Sec.

"Door open too long" event after: off Min.

Lock bolt

Number of turns to lock: off

"Door securely locked" bolt position: off

Events

Logging in the access list

- "Door open" events
- Lock bolt events

Transmission in the network

- "Door open" events
- Lock bolt events

Logging / transmission of alarms in the network

Since an open door will not emit an alarm, an event needs to be generated when the door is opened. The event becomes active and a pre-defined action is implemented as soon as the door is opened.

6. Day-to-day operation

6.1 Displays

You can display the key information about your locking system directly in the locking plan. The DM Cylinder's door statuses can be shown directly on the locking plan

- This view is only useful if the DM Cylinder is connected online
- If a wireless node (LockNode) fails, the system does not detect the fault until the cylinder is addressed by the LSM (reading, reprogramming). That is why it is sensible to check the status of the WaveNet network
- The cylinders transmit all status changes to LSM (LSM Basic Online) or the CommNode server (Business / Professional) in real time. If LSM is closed, the status displayed at that moment is saved
- If a door status changes while LSM is closed (Basic) or the CommNode server has been paused (Business / Professional), the system does not record this change. The correct status is not displayed until a change has been made to the status at the door

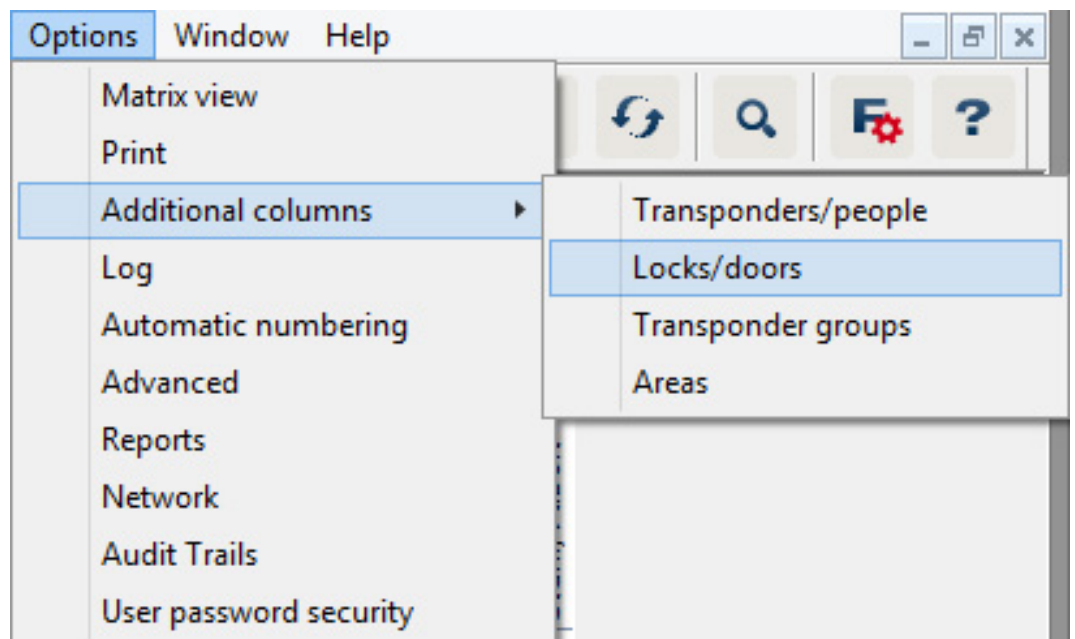

Fig. 14: Additional columns in the locking plan

1. Click on 'Options' > 'Additional columns' > 'Locking devices/doors' in the menu row

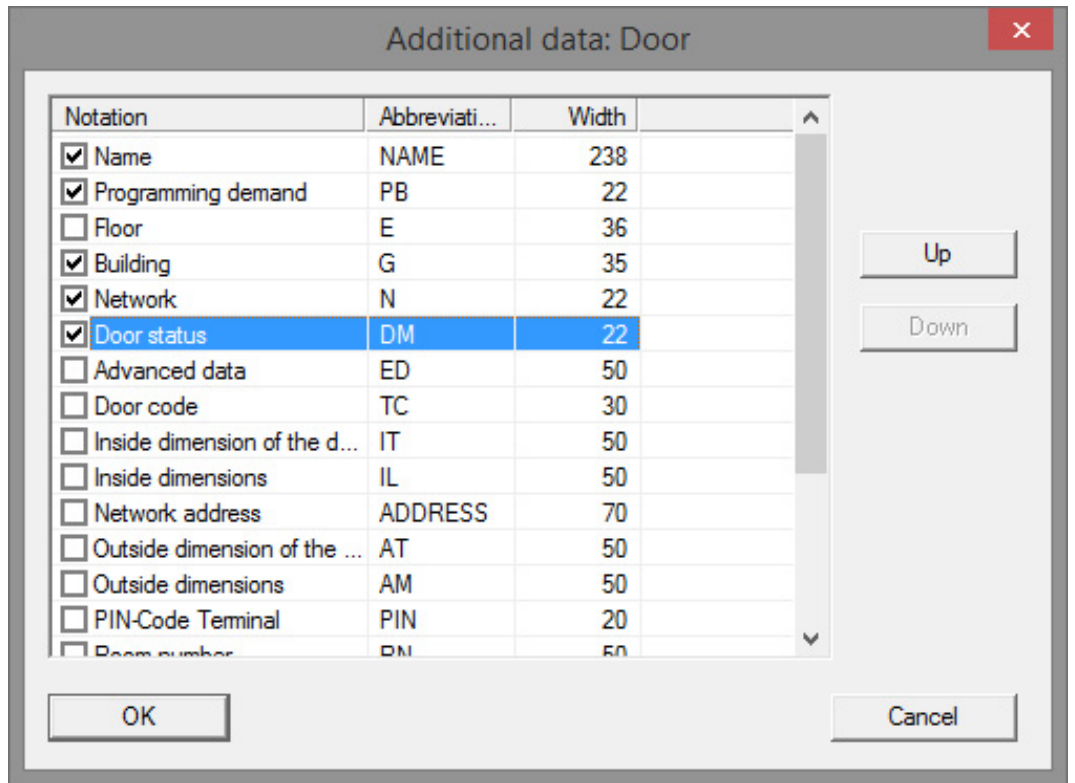







Fig. 15: Column selection

2. Select 'Network' and 'Door status'
 3. Click on [Up] and [Down] to change the order of the list
- ↳ The network connection and door status are now displayed in the locking plan

Matrix view

NAME (DOORS/LOCKS)		PB	E	G	N	DM										
Medic Dr. Kiefer	Examination 1	⚡										X	X	X	X	X
	Examination 2	⚡										X	X	X	X	X
	Lab	⚡										X	X		X	X
	Main entrance											X	X	X	X	X
	Side entrance	⚡										X	X		X	X
	Waiting room	⚡										X	X	X	X	
Medic	Medicine	⚡										X			X	
	Medicine II						W					X			X	

The door statuses are displayed using different icons in the matrix

Icon	Status	Information
	Door securely locked	Door is locked and cam has been rotated to [securely locked] position
	Locked	Door is locked and cam has not been rotated as far as the [securely locked] position
	Closed	Door is closed and bolt retracted
	Open	Door open
	Error message - undefined status / warning / alarm	This icon has different meanings: Door open too long Fastening screw has been manipulated (no longer addresses, has been removed) Magnetic field manipulation (magnetic field on the fastening screw is too extensive) Door has been forced open (door is opened despite locking)
	Status unknown	Undefined status – the status is unknown due to a malfunction or a non-logical change to the system

Tab. 2: Door monitoring icons in the matrix

Unknown status

The 'Unknown status' icon and the alarm icon do not change automatically if the reason for the malfunction disappears (an exception is the 'Door open too long alarm' which does not disappear when the door is closed). The alarm must be reset

Error message	Action
Undefined door status	Door must be opened, then closed again. Cylinder detects the status and transmits it to LSM
Door open too long	Close door
Fastening screw has been manipulated (has been removed)	Check fastening screw. Reset the error once it has been eliminated; see section on <i>Cylinder</i> [▶ 20]
Magnetic field manipulation (fastening screw magnetic field too extensive)	Check door. Reset error; see section on <i>Cylinder</i> [▶ 20]

Error message	Action
Door has been forced open (door is opened despite locking)	Check door. Reset error

6.2 Read component

A locking device's status can be read at any time

You can use a programming device to read locking devices which are not networked. You can read networked locking devices over the network from your workstation

1. Highlight the locking device in the locking plan
2. Click on 'Programming' in the menu
3. Select 'Read locking device/set time'

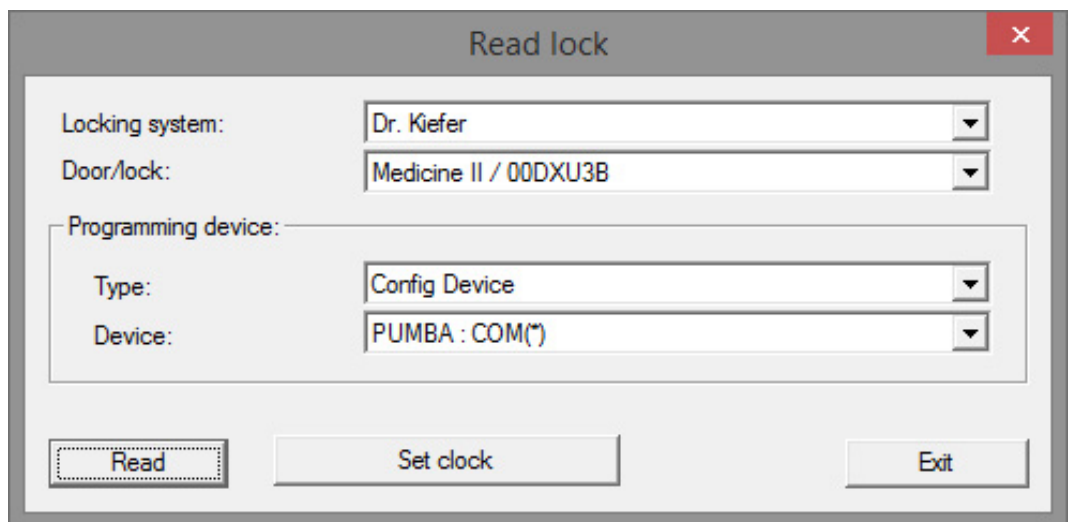

4. Check locking system and door/locking device
5. Choose the right programming device
 - Config device: if the locking device is to be read with a programming
 - LockNode: if the locking device is to be read online via an external

LockNode

- WaveNet Node: if the locking device is to be read online via a WaveNet node and an integrated LockNode (LN.I)

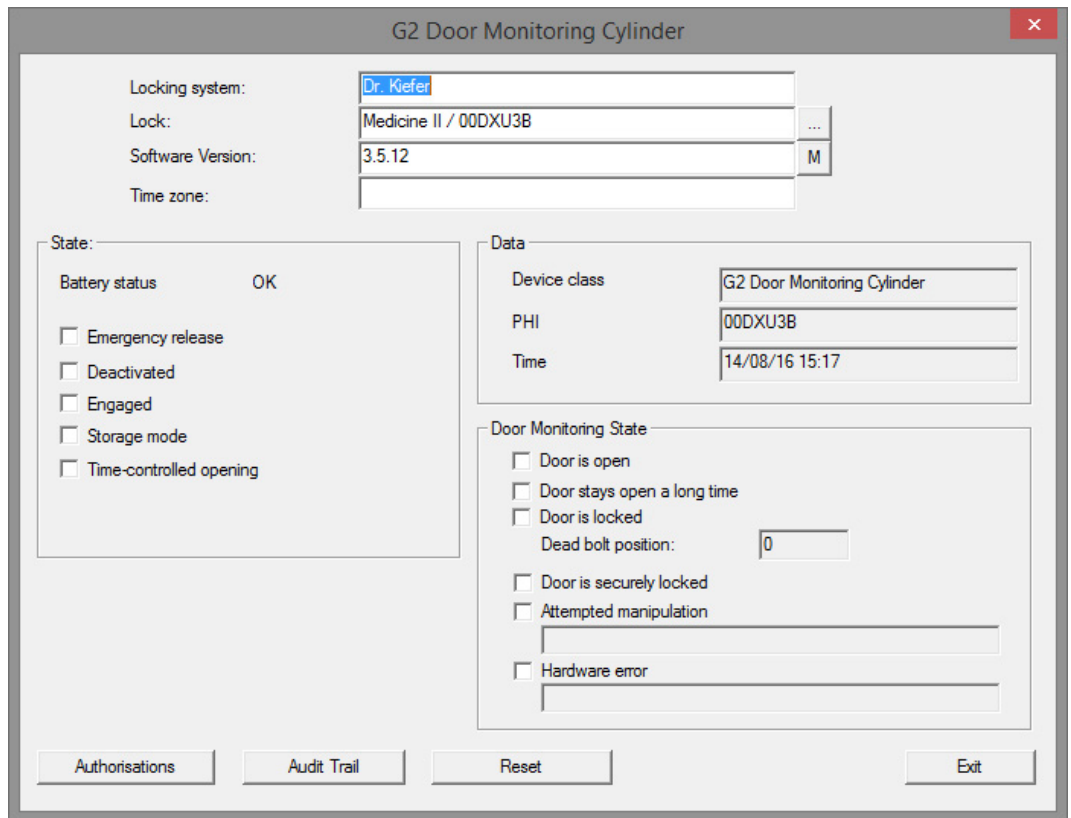

6. You see the battery status and the door monitoring status

7. Click on [Authorisations] to display the authorised ID media

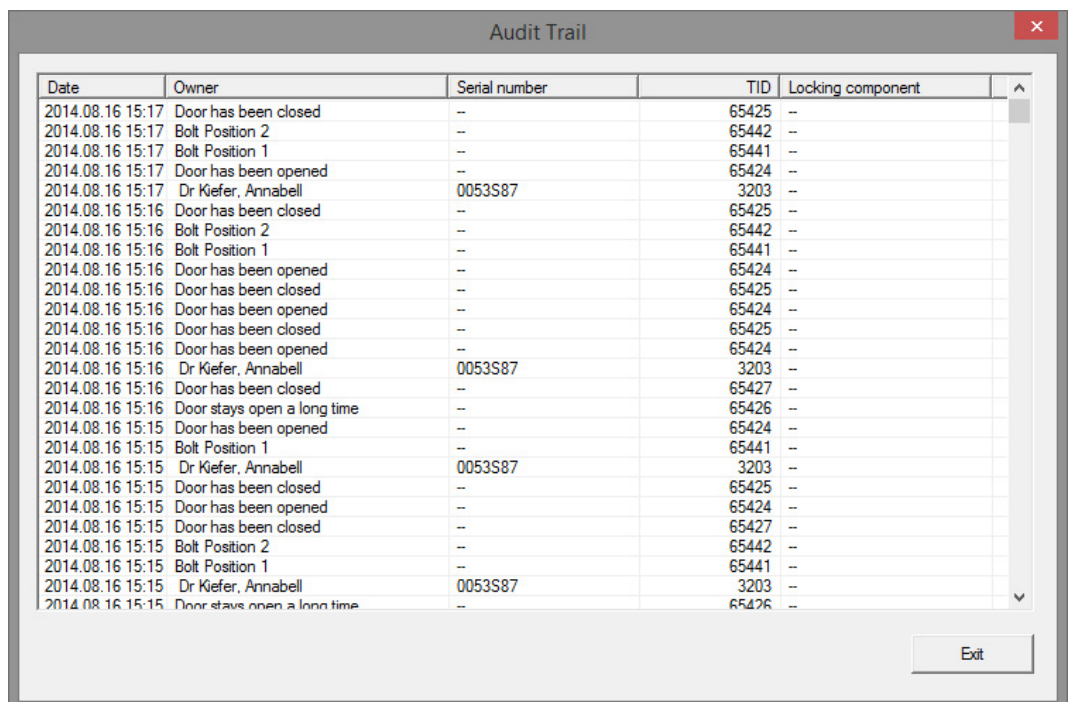

8. Click on [Access list] to read accesses. Bolt positions and door statuses are also read with the DoorMonitoring Cylinder

7. Possible DoorMonitoring states of locking cylinders

- Door open/closed
- Door locked
- Door securely locked
- Door open for too long
- Forend screw manipulated

8. Maintenance

8.1 Audible signals

Signal type	Meaning	Action required
2 short audible signals before engaging and a short tone after disengaging	Normal activation	No
1 short audible signal: cylinder does not engage.	Attempted entry with a transponder listed in the locking system, but: booked outside the time zone: no authorisation, cylinder is deactivated	Check authorisations. Read locking device, check status. Check time zone plan
8 short audible signals before engaging: Battery Warning Level 1	Batteries are low	Replace batteries in the cylinder
8 short audible signals 30 seconds long with one second pause each time before engaging: Battery Warning Level 2	Batteries are almost completely empty	Replace batteries in the cylinder immediately.
6 audible signals (long – pause – short): Freeze mode	Battery empty. Cylinder can no longer be opened using an authorised transponder.	Replace batteries and reset with a battery replacement transponder.
8 short audible signals after thumb-turn disengages	Transponder battery is low	Have transponder battery replaced

Tab. 3: Cylinder audible signals

8.2 Batteries

Battery life

The battery life depends on the DM Cylinder configuration settings and the use behaviour. The following affect the battery life:

- The fastening screw sampling interval
- Number of activations
- Reading the access list

- Changes to programming
- Number of tasks

The number of activations totals up to 50,000.
The battery life depends on the fastening screw setting:

Sampling interval	Battery lifetime
0.2s	2.5 years
2s	4 years
3s	4.5 years

Tab. 4: Sampling intervals and battery life

The battery life indicated serves as a guide. A battery warning is not emitted when the aforementioned service life expires, but is based on the measured battery capacity instead.

Battery warning levels

Warning Level 1	Warning Level 2	Freeze mode
8 short audible signals before engaging	Eight short audible signals 30 seconds long with one second pause each time before engaging	6 audible signals (long – pause – short)
Up to 15,000 access events or up to 9 months on standby	Up to 50 access events or up to 30 days	Battery change: activate with battery replacement transponder

Tab. 5: DM Cylinder battery warning levels



NOTE

The cylinder's monitoring function is deactivated from Warning Level 2. Changes to the cylinder status are not logged or transmitted.

Once Warning Level 2 has been emitted for the first time, the door can be opened with a transponder around 50 times. After reaching this number of opening operations or after about 4 weeks, the cylinder automatically switches to freeze mode. In freeze mode, the cylinder can only be replaced using a battery replacement transponder in conjunction with an authorised transponder.

Freeze mode

The locking device switches to freeze mode if Battery Warning Levels 1 and 2 have not been observed or the locking system administrator has not been informed of the battery warning. User transponders can no longer activate the locking device to prevent the battery from being fully discharged in this status.



NOTE

A door can only be opened with a battery replacement transponder once in freeze mode.

Normal transponders can no longer open a door

- Replace the batteries immediately after the first warning level starts

Battery replacement

- ✓ You have a battery replacement key
 - ✓ You have a battery replacement transponder
 - ✓ You have new battery replacement batteries
 - ✓ You have an authorised transponder
1. If the cylinder is in freeze mode, activate the battery replacement transponder
 - ↳ The cylinder can now be opened with an authorised transponder
 2. Activate the authorised transponder
 3. Replace the batteries
 4. Activate the battery replacement transponder
- ↳ Freeze mode is permanently eliminated. The cylinder can be operated as normal

Replacing batteries

1. Place the installation/battery key on the inside thumb-turn in such a way that the two teeth lock into the openings in the locking disc; if necessary, turn the thumb-turn until both teeth engage into the locking disc. Important: The tool must be placed flat on the inside front surface of the recessed grip ring to ensure that the installation tool can engage into the locking disc. . Use clean gloves free of fat or grease to handle new batteries.
2. Hold the inside thumb-turn firmly and carefully turn the installation/battery key about 30° in a clockwise direction until you hear a click.
3. Remove installation/battery key from the thumb-turn
4. Push recessed grip ring backwards towards the door, so that it comes away from the thumb-turn

5. Hold recessed grip ring firmly and turn thumb-turn about 10° in an anti-clockwise direction and remove
6. Carefully remove both batteries from the holder
7. Insert the new batteries into the holder at the same time with the positive poles next to each other; change the batteries as quickly as possible



NOTE

Always insert button cells with the positive poles next to each other

The batteries will only offer their full service life if they are installed correctly



NOTE

Batteries will corrode if they come into contact with sweat or grease

Batteries will lose their capacity before time

Corroded batteries may permanently damage the cylinder

1. Never touch batteries with your bare hands
2. You must wear clean gloves free of fat or grease to handle new batteries

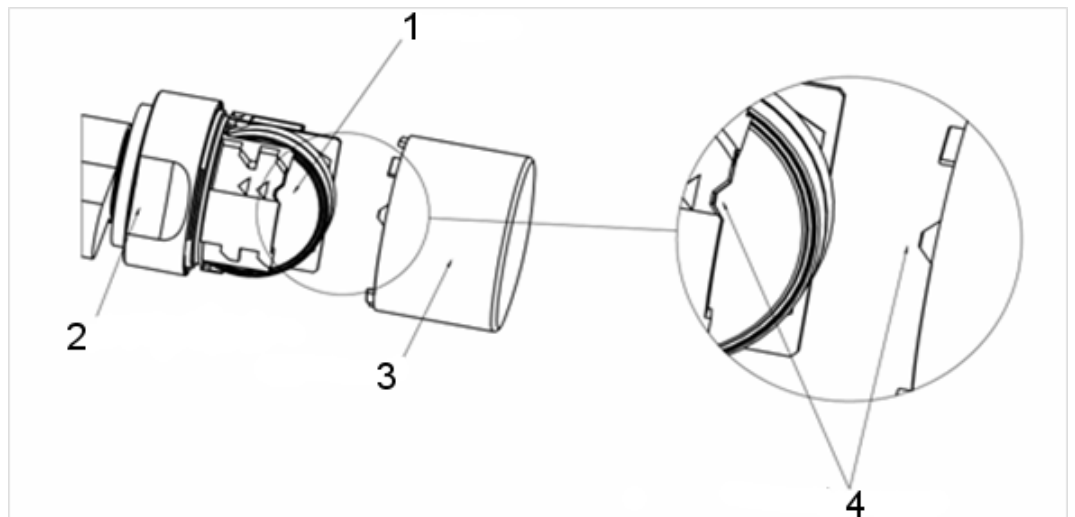

8. Replace the thumb-turn (align the triangle mark as in the diagram[4]), hold the recessed grip firmly (see diagram) and fasten the inside thumb-turn by turning in a clockwise direction about 10°
9. Push recessed grip ring back onto the thumb-turn, so that the thumb-turn and ring close together in a flush fit
10. Place the installation/battery key on the inside thumb-turn in such a way that the two teeth lock into the openings in the locking disc; if necessary, turn the thumb-turn until both teeth engage into the locking disc

11. Close the thumb-turn again by turning it about 30° in a clockwise direction until you hear a click
12. Then activate an authorised transponder and check that it functions

8.3 Error diagnosis

Symptom	Cause	Solution
Fastening screw cannot be fully tightened	Fastening screw too long	Re-measure backset. Order fastening screw according to backset size You must not shorten the fastening screw under any circumstances. This will permanently damage the sensor
Fastening screw does not grip when turned	Fastening screw too short	Re-measure backset Order fastening screw according to backset size
Door status is not shown in LSM	Connection between cylinder and LSM is malfunctioning	Check whether the error also occurs when the cam bit rotates. If it does, the connection is malfunctioning. Check network Is the cylinder (network cover) integrated into the network? Check that the signal strength is at least -70 dB
	Magnetic field around fastening screw sensor too weak The sensor does not detect the magnetic field if it is too weak	Affix additional magnetic plate Reduce gap between door and frame

Symptom	Cause	Solution
	<p>Magnetic field around fastening screw sensor too strong</p> <p>The sensor overreaches if the magnetic field too strong</p>	<p>Remove magnet plate</p> <p>Increase gap between door and frame</p>
	<p>Fastening screw too short.</p> <p>No contact between the sensor in the fastening screw and the cylinder</p>	<p>Re-measure backset</p> <p>Order fastening screw according to backset size</p>
	<p>DM Cylinder configured incorrectly</p>	<p>Check DM Cylinder configuration.</p> <p>Is there a check mark against 'Door open' in the access list?</p> <p>Is transmission via network configured?</p> <p>Is sampling interval configured for fastening screw?</p>
		<p>Flip-flop mode or time switch-over configured?</p> <p>> The bolt status cannot be checked</p>
	<p>Input events via WaveNet not configured</p>	<p>Configure input events by selecting Network/Group tasks/WaveNet node / Activate input events</p>

Symptom	Cause	Solution
	Event forwarding not activated	Check whether status has been read Set check mark against Event forwarding Also select WaveNet node properties at Network / Administer WaveNet
	Defective cylinder	Replace cylinder
	CommNode server not assigned to task services	If network tasks are distributed via the CommNode server, you need to select this in task services. Select 'Network' » 'Task Manager' Select the CommNode server in the Task services section Then transmit the config files in the 'Communications node' menu
	CommNode server not installed	The CommNode needs to be installed in certain set-ups: <ul style="list-style-type: none"> ■ LSM Business ■ LSM Basic with Virtual Network (VN)
	Locking system with Virtual Network (VN)	The config files must be re-transmitted to the CommNode server with LSM.Basic.Databases with VN configuration to ensure that the door monitoring function is detected

Symptom	Cause	Solution
Cam rotation is not shown in LSM. Door opening is shown	DM Cylinder configured incorrectly	Configure lock dead bolt logging. Check box for event logging and forwarding of lock dead bolt events
	DM Cylinder activated in flip-flop mode or time switch-over	DM Cylinder cannot be operated in flip-flop mode or time switch-over. Change mode and open and close door, so that cylinder returns to a defined status
	Defective cylinder	Replace cylinder
A different status is displayed in LSM to the actual status	LSM has not been synchronised with the cylinders	See 'Forward events' in this section for description
	Network connection unstable	Check whether network is available, e.g. read cylinder over the network. Check signal strength: at least -70 dB. Examine surroundings for sources of interferences, such as fluorescent tubes, dim switches, generators, mains adapters

Forward events

If the door statuses are not displayed in LSM, check the network configuration.

First, determine the locking device's network detection

- ✓ The 'Network' column is shown in the locking plan. The 'W' is visible in the locking plan
1. Position the mouse cursor on the 'W' in the locking plan > The WaveNet node number is displayed, e.g. WNNode_0026
 2. Note down the identifier for later use

Activate input events

The input events must be activated, so that events can be transmitted from the cylinder to the LockNode

1. Open the menu item 'Network' > 'Collective tasks' > 'WaveNet nodes'
2. Highlight the node which features the number that you wrote down earlier
3. Click on [Activate input events]

↳ The input events are activated

1. Open WaveNet administration > 'Network' > 'Administer WaveNet'
2. Select the network segment with the required WaveNet node
3. Highlight the door 'Nodes/addresses'
4. Click on [Properties]
5. Activate the check mark for 'Activate forwarding of events' in the 'Configuration' section
6. Click on [Programme]
7. Close the window

9. Accessories

Battery set

There is a set of batteries with replacement batteries available for the cylinder. The set consists of 10 CR2450 batteries.

Order code: Z4.BAT.SET

Fastening screw

The DM Cylinder requires a special fastening screw with an integrated door opening sensor.

Order code: Z4.DM.xx.SCREW.n

Fastening screw xx indicates the locking device's backset and should not be confused with the fastening screw length. Standard fastening screws are supplied for backsets between 25 and 70mm at increments of 5 mm. Special lengths available on request.

Screwdriver

The screw head on the fastening screw rises in the middle, so that the fastening screw cannot be fastened with a normal slot screwdriver. A screwdriver is available as a tool.

Order code: Z4.DM.SCREWDRIWER

WaveNet network cover LN.I

The WaveNet network cover is a replacement cover and contains the electronics required to connect the DM Cylinder with the network.

10. Technical specifications

Cylinder model	Euro Profile DoorMonitoring Cylinder as per DIN 18252/EN1303, stainless steel, freely rotating on both sides
Protocol generations	G2 or MobileKey
Thumb-Turn diameter	30 mm
Basic installation length	30-35 mm (external/internal dimension)
Protection rating	IP54 (when installed) / .WP variant: IP66
Air humidity:	< 95%; non-condensing
Battery type	2 x lithium, CR2450, 3 V
Battery life	Up to 50,000 actuations or 4 years on standby with a fastening screw sampling interval of 2 seconds
Temperature range	Operational: -25 °C to +65 °C In storage: -35 °C to +50 °C
Access memory	About 1,000 door statuses can be stored
Time zone groups	100+1 (time zone groups are not supported in MobileKey)
Number of transponders per locking cylinder	Up to 64,000 or 100 for MobileKey
Networking	Network-ready with integrated LockNode (Network Thumb-Turn Cover WNM.LN.I)

Tab. 6: Technical specifications - DoorMonitoring Cylinder

Radio emissions

24.50 kHz - 25.06 kHz Only for item numbers: Z4.*, Z4.*MH*	-20 dB μ A/m (10 m distance)
13.564 MHz - 13.564 MHz Only for item numbers: Z4.*MH*, Z4.*MP*	-19.57 dB μ A/m (10 m distance)

11. Declaration of conformity

The company SimonsVoss Technologies GmbH hereby declares that the articles (Z4.*, Z4.*MH*, Z4.*MP*) comply with the following guidelines:

- 2014/53/EU -RED-
or for the UK: UK statutory 2017 No. 1206 -Radio equipment-
- 2011/65/EU -RoHS-
or for the UK: UK statutory 2012 No. 3032 -RoHS-



The full text of the EU Declaration of conformity is available at the following internet address: www.simons-voss.com/en/certificates.html.

The full text of the UK Declaration of conformity is available at the following internet address: www.simons-voss.com/en/certificates.html.

12. Help and other information

Information material/documents

You will find detailed information on operation and configuration and other documents on the website:

<https://www.simons-voss.com/en/documents.html>

Declarations of conformity

You will find declarations of conformity and other certificates on the website:

<https://www.simons-voss.com/en/certificates.html>

Information on disposal

- Do not dispose the device (Z4.*, Z4.*MH*, Z4.*MP*) in the household waste. Dispose of it at a collection point for electronic waste as per European Directive 2012/19/EU.
- Recycle defective or used batteries in line with European Directive 2006/66/EC.
- Observe local regulations on separate disposal of batteries.
- Take the packaging to an environmentally responsible recycling point.



Technical support

Our technical support will be happy to help you (landline, costs depend on provider):

+49 (0) 89 / 99 228 333

Email

You may prefer to send us an email.

support-simonsvoss@allegion.com

FAQs

You will find information and help in the FAQ section:

<https://faq.simons-voss.com/otrs/public.pl>

Address

SimonsVoss Technologies GmbH
Feringastr. 4
D-85774 Unterfoehring
Germany



This is SimonsVoss

SimonsVoss, the pioneer in remote-controlled, cable-free locking technology provides system solutions with a wide range of products for SOHOs, SMEs, major companies and public institutions. SimonsVoss locking systems combine intelligent functionality, high quality and award-winning design Made in Germany.

As an innovative system provider, SimonsVoss focuses on scalable systems, high security, reliable components, powerful software and simple operation. As such, SimonsVoss is regarded as a technology leader in digital locking systems.

Our commercial success lies in the courage to innovate, sustainable thinking and action, and heartfelt appreciation of employees and partners.

SimonsVoss is a company in the ALLEGION Group, a globally active network in the security sector. Allegion is represented in around 130 countries worldwide (www.allegion.com).

Made in Germany

SimonsVoss is truly committed to Germany as a manufacturing location: all products are developed and produced exclusively in Germany.

© 2024, SimonsVoss Technologies GmbH, Unterföhring

All rights are reserved. Text, images and diagrams are protected under copyright law.

The content of this document must not be copied, distributed or modified. More information about this product can be found on the SimonsVoss website. Subject to technical changes.

SimonsVoss and MobileKey are registered brands belonging to SimonsVoss Technologies GmbH.

SimonsVoss
technologies

Made in Germany

A BRAND OF

ALLEGION