

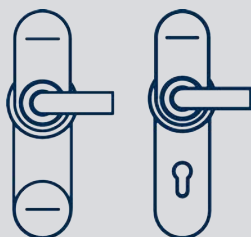

Simons  Voss

DE Kurzanleitung
EN Quick Guide
FR Guide abrégé
NL Korte handleiding
IT Guida breve
DK Kort vejledning
SE Snabbguide



**Digital SmartHandle AX
Panic bar**

BS21.990605
08.03.2024

Simons  Voss
technologies

Abbildungen/Images	3
deutsch	30
english	35
français	40
nederlands	45
italiano	50
dansk	55
svensk	60

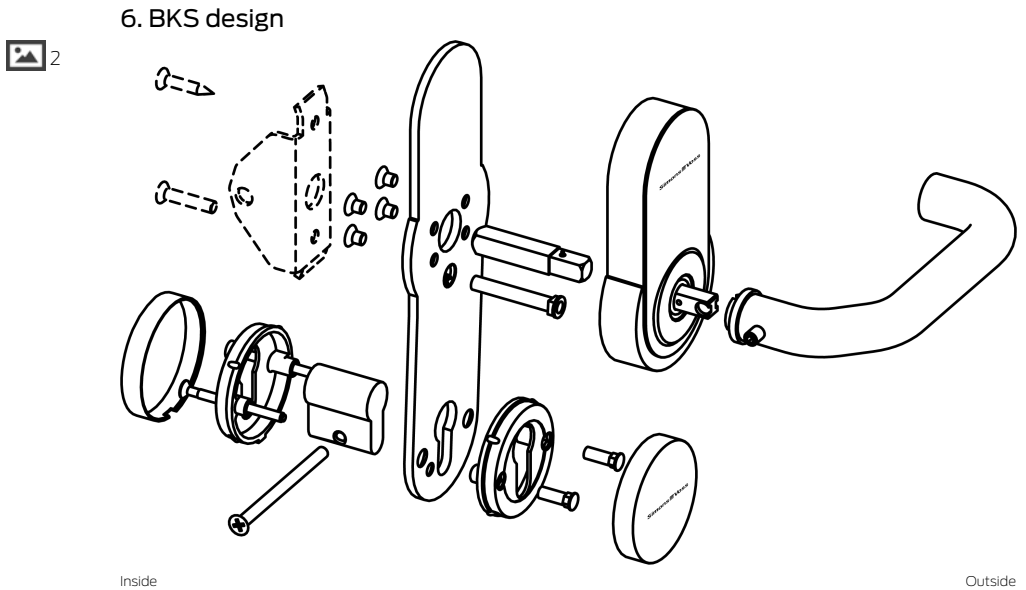
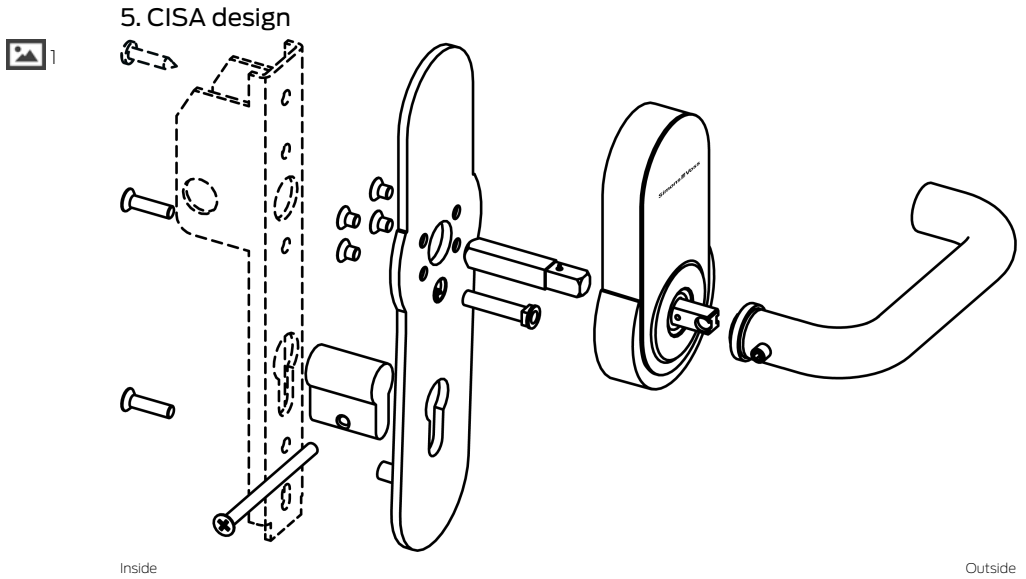

7. Preparing the door for CISA (drilling template)



PH2



Ø6.5



Ø8.0

 3

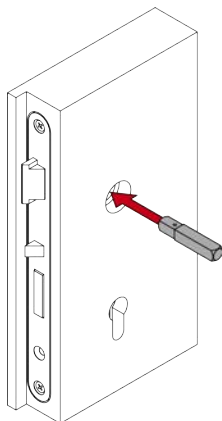

 4

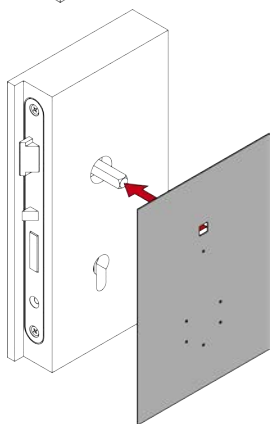

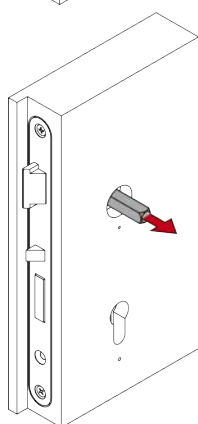
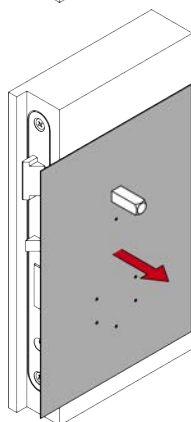
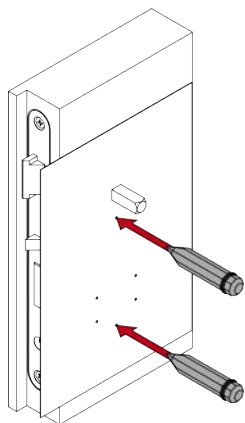

8



PH2

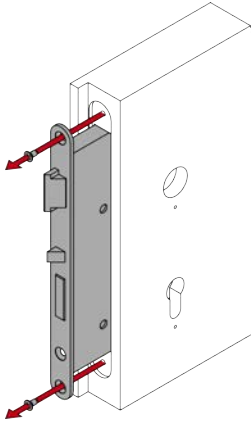

9



$\text{Ø}6.5$



$\text{Ø}8.0$

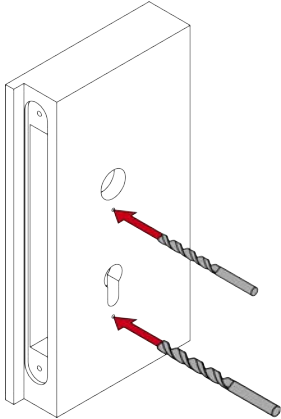

10

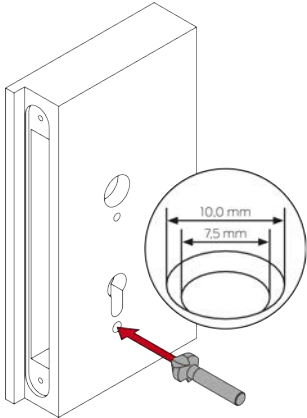

11



PH2

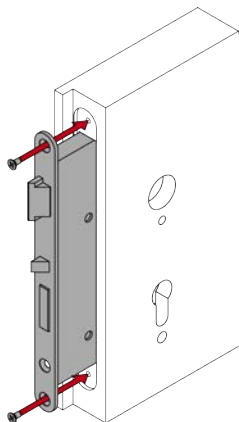

8. Preparing the door for BKS (drilling template)



PH2



Ø6.5



Ø8.0

12



PH2

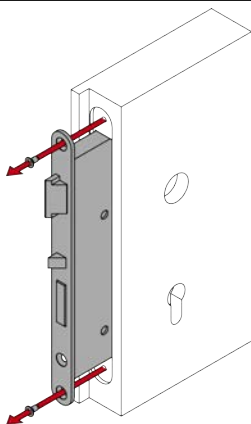

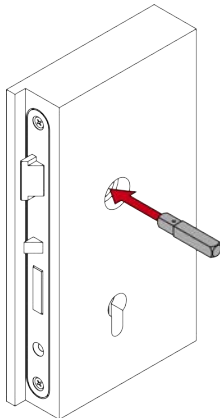
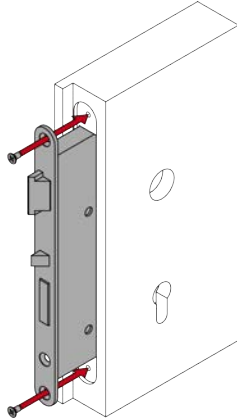
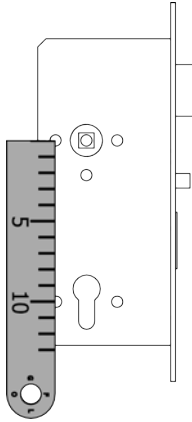

 4

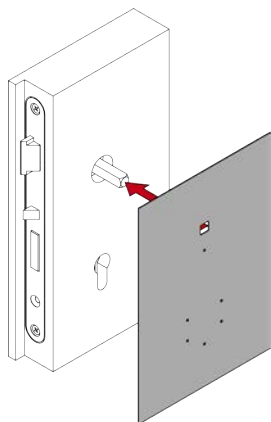

 17

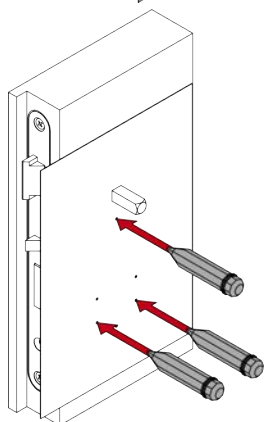

 6

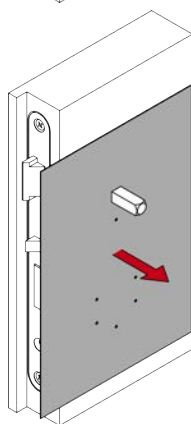

19

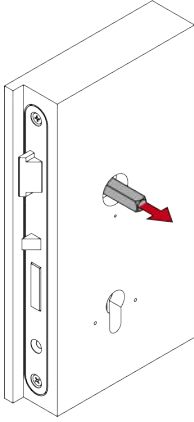

20



PH2

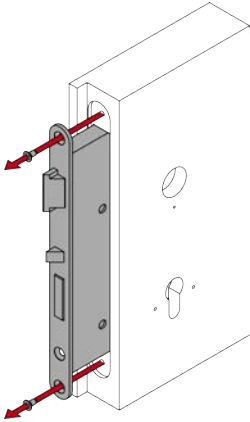

21



Ø6.5



Ø8.0

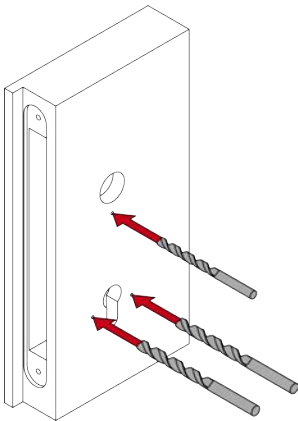

22



PH2

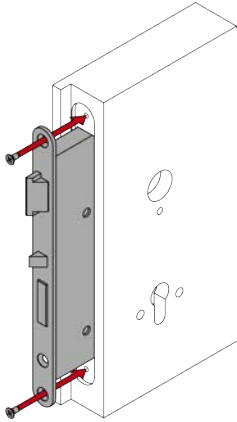

9. Programming the fitting

23

*System3060

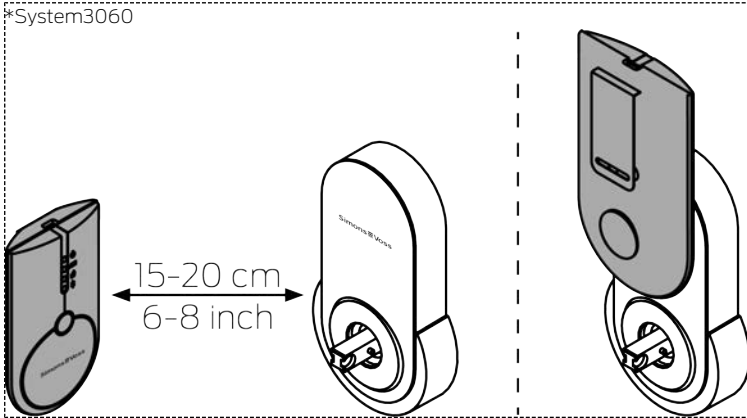

24

*SI-WO

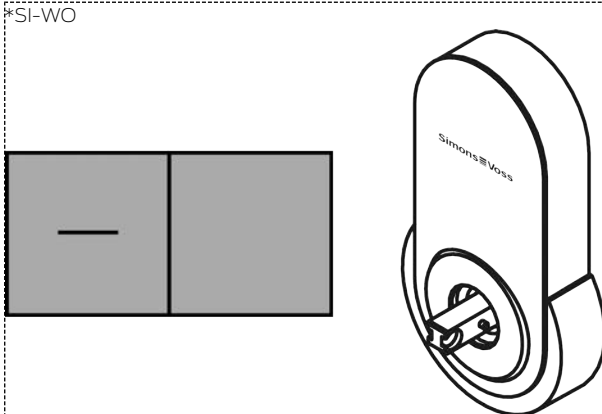

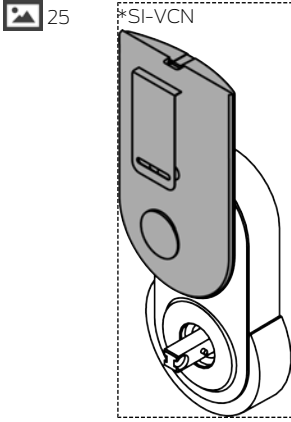

10. Installing the fitting for CISA

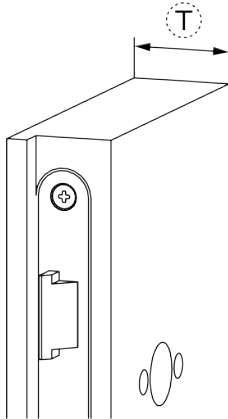

Door thickness - 10 mm (±2 mm)



Door thickness + 14.5 mm (±0.5 mm)



29

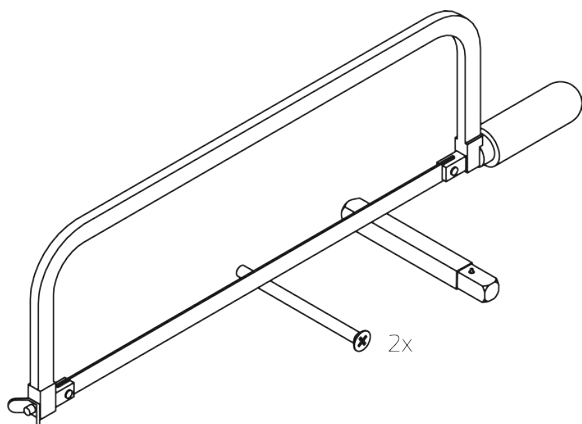

30

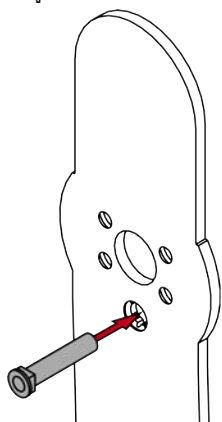

31

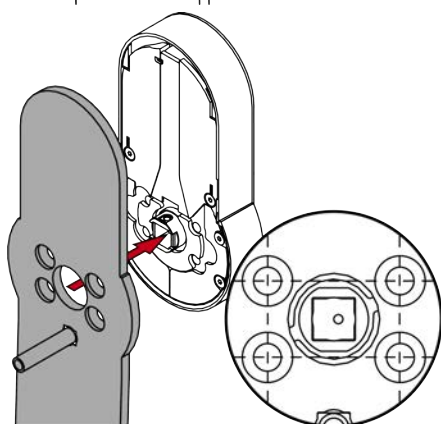

 32



PH2



1.1 Nm
±10%

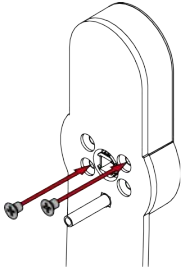

 33



PH2



1.1 Nm
±10%

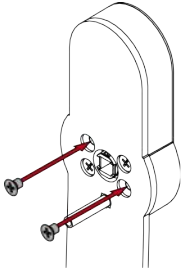

 34

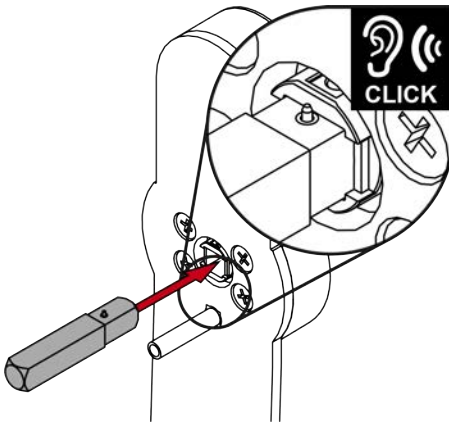

 35

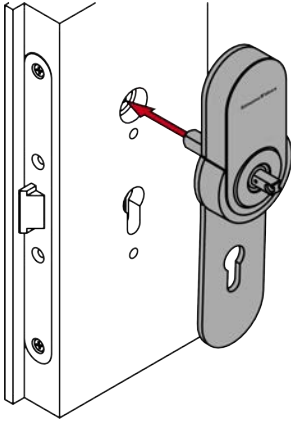

 36



PH2



1.1 Nm
±10%

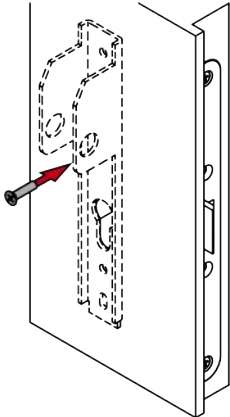

 37



PH2



1.1 Nm
±10%

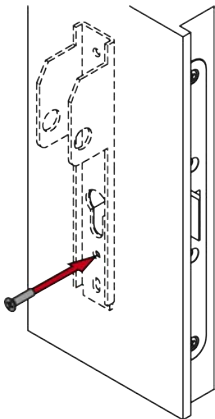

38

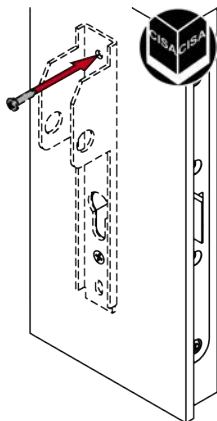

39

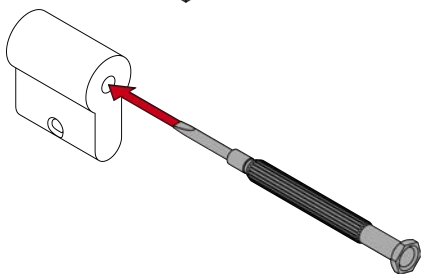

40

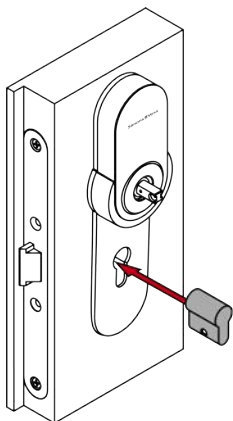

41

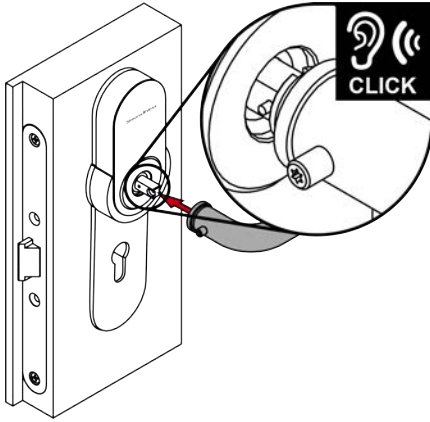

42



TX15



5.0 Nm
±20%

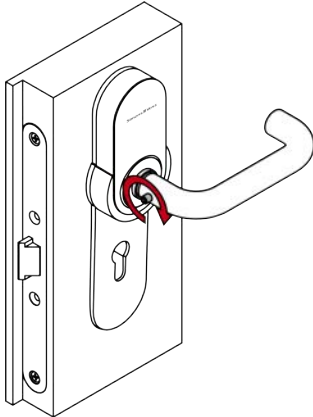

43



PH2



1.1 Nm
±10%

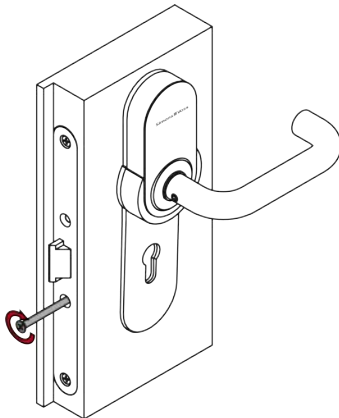

11. Installing the fitting for BKS



PH2

TX15

26

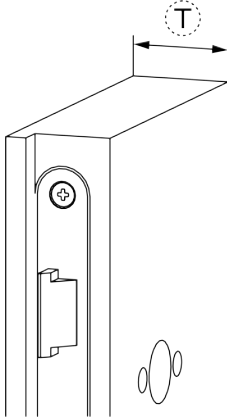

45



L1: door thickness - 12 mm (± 5 mm)

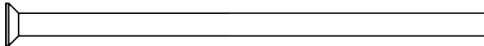

46

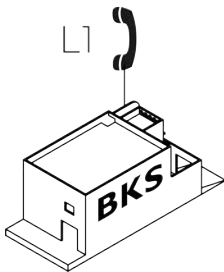

47



L2: door thickness + 12 mm (± 3 mm)

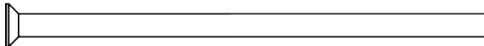

48

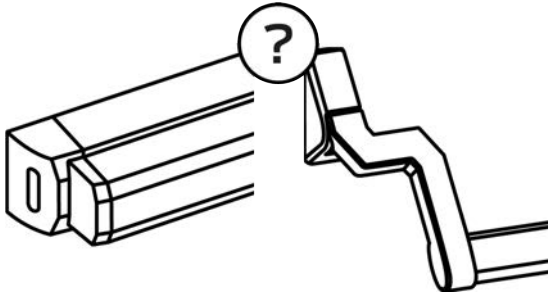

$X = 32 \text{ mm}$ $X = 23 \text{ mm}$

49

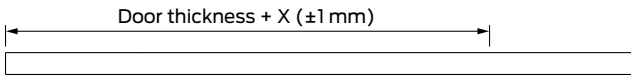

50

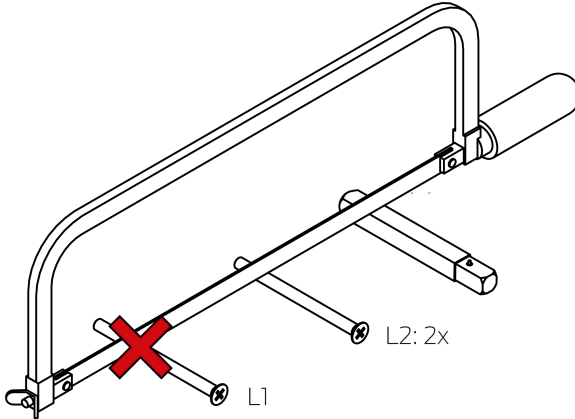

30

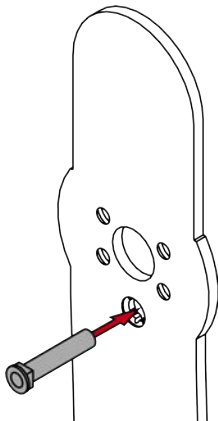

31

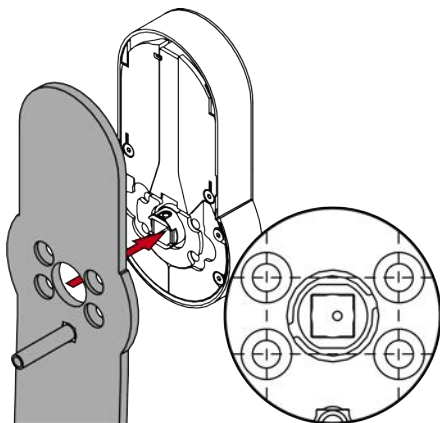

32

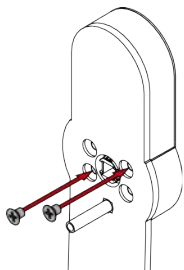

PH2

1,1 Nm
±10%

33

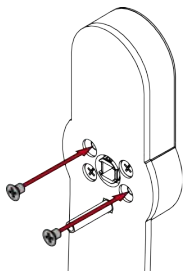

PH2

1,1 Nm
±10%

34

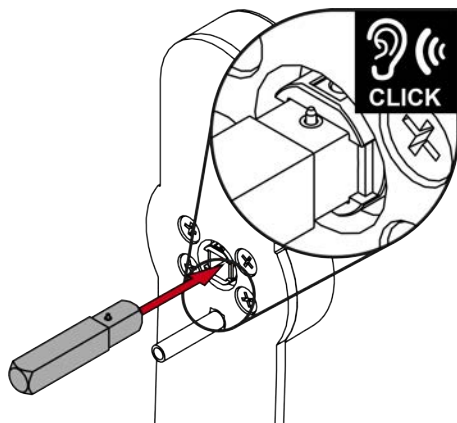

56

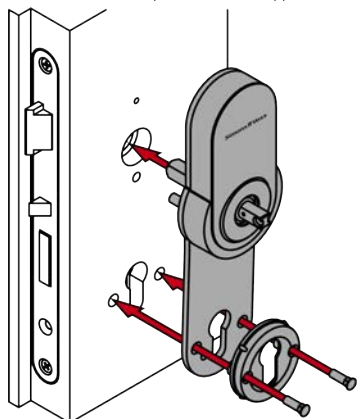

57

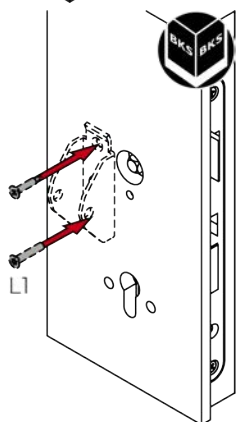

58



PH2



1.1 Nm
±10%

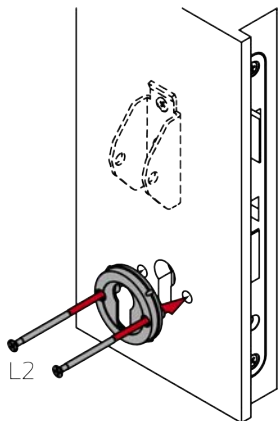

39

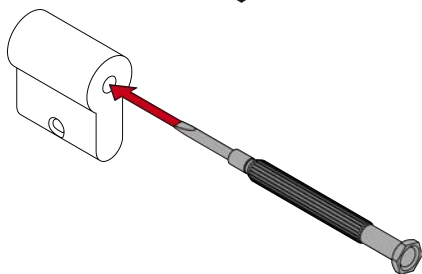

60

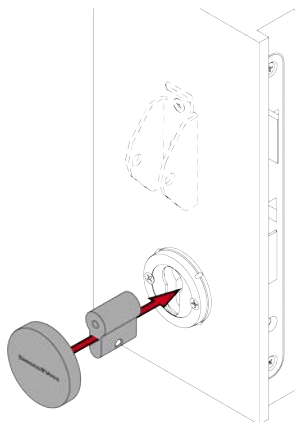

61

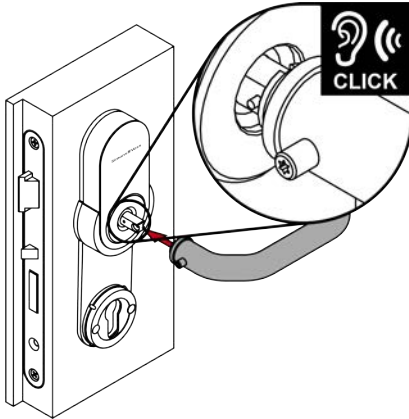

62



TX15



5.0 Nm
±20%

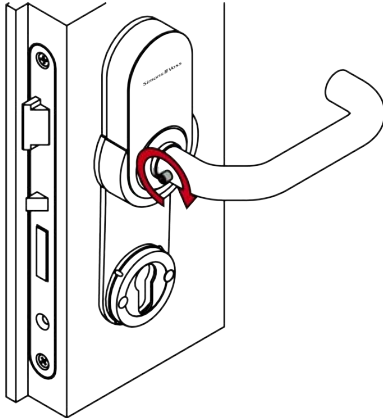

63



PH2



1.1 Nm
±10%

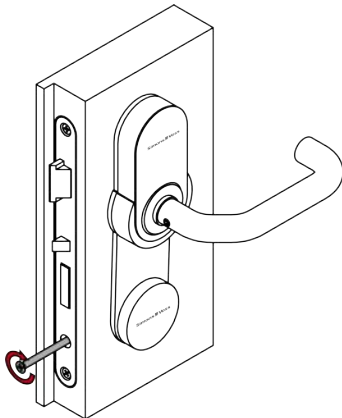

12. Removing the fitting



SW1.5

64



SW1.5

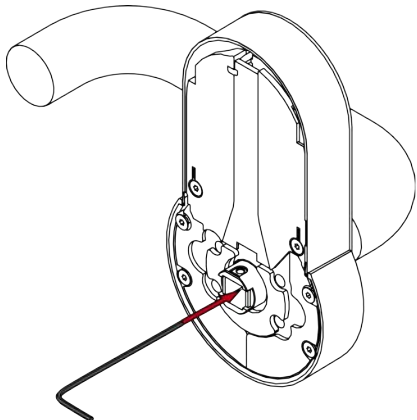

65



SW1.5

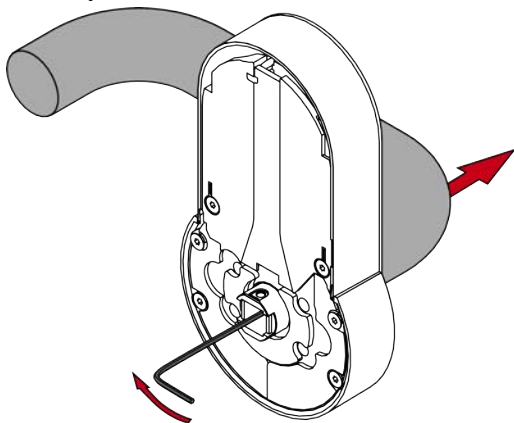

13. Replacing the batteries



66

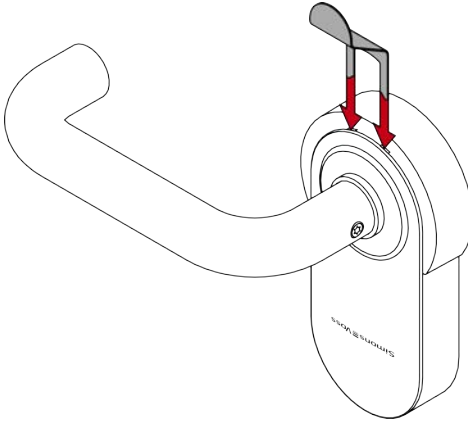

67

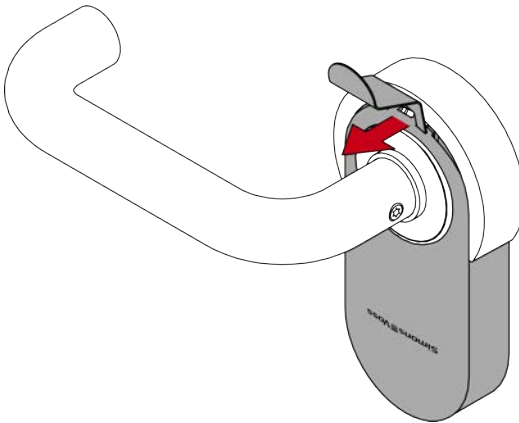

68

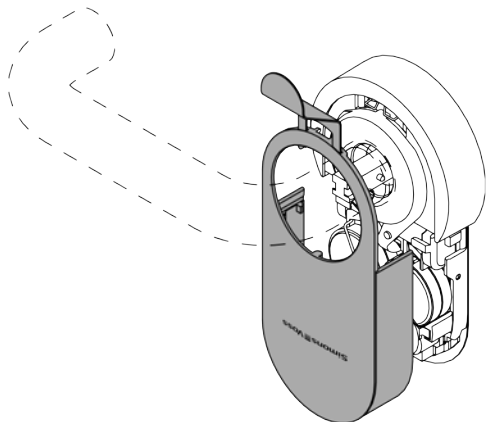

69

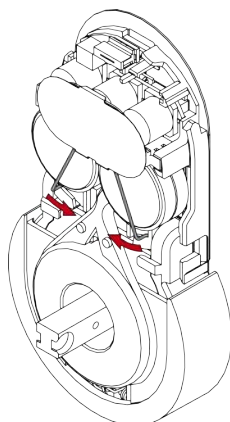

70

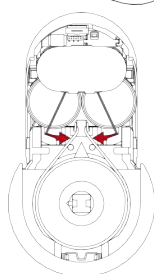

 71

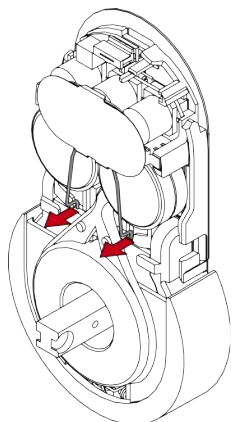

 72

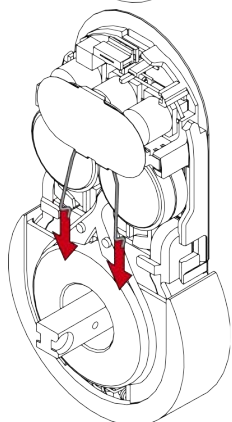

 73

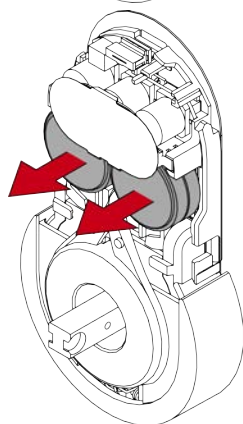

 74

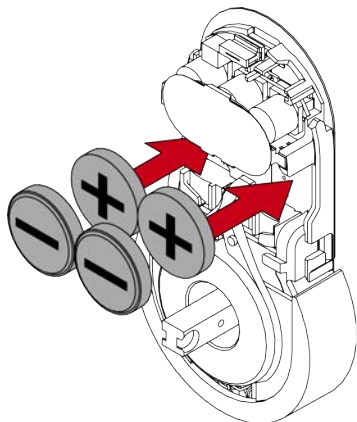

 75

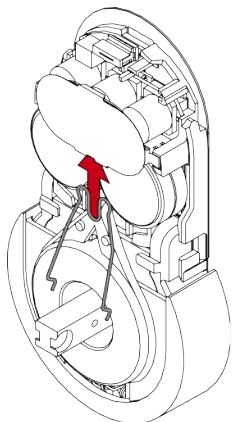

 76

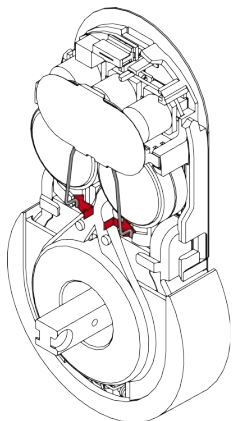

 77

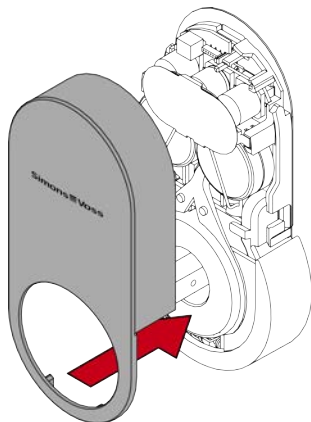

 78

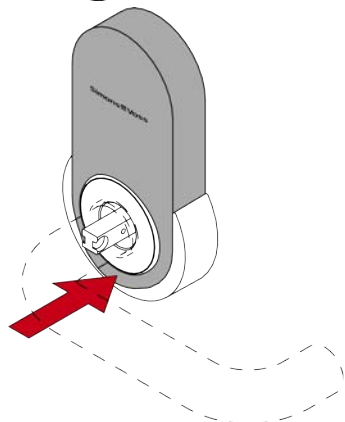

16. Help and other information

 79



1. Bestimmungsgemäßer Gebrauch

Bei den Produkten der SmartHandle AX-Serie handelt es sich um elektronische Türbeschläge. Mithilfe eines berechtigten Identifikationsmediums kann das SmartHandle AX einkuppeln und die entsprechende Tür öffnen.

Entsprechende Berechtigungen müssen mit Hilfe eines elektronischen Schließplans erteilt werden.

Produkte der SmartHandle AX-Serie dürfen nur für das Öffnen und Schließen von Türen genutzt werden. Ein anderer Gebrauch ist nicht zulässig.

2. Allgemeine Sicherheitshinweise

Signalwort: Mögliche unmittelbare Auswirkungen bei Nichtbeachtung

WARNUNG: Tod oder schwere Verletzung (möglich, aber unwahrscheinlich).

VORSICHT: Leichte Verletzung, **ACHTUNG:** Sachschäden oder Fehlfunktionen, **HINWEIS:** Geringe oder keine



WARNUNG

Verperrter Zugang

Durch fehlerhaft montierte und/oder programmierte Komponenten kann der Zutritt durch eine Tür verperrt bleiben. Für Folgen eines verperrten Zutritts wie Zugang zu verletzten oder gefährdeten Personen, Sachschäden oder anderen Schäden haftet die SimonsVoss Technologies GmbH nicht!

Verperrter Zugang durch Manipulation des Produkts

Wenn Sie das Produkt eigenmächtig verändern, dann können Fehlfunktionen auftreten und der Zugang durch eine Tür verperrt werden.

- ❌ Verändern Sie das Produkt nur bei Bedarf und nur in der Dokumentation beschriebenen Art und Weise.

Batterie nicht einnehmen. Verbrennungsgefahr durch gefährliche Stoffe

Dieses Produkt enthält Lithium-Knopfzellen. Wenn die Knopfzelle verschluckt wird, können schwere innere Verbrennungen innerhalb von gerade einmal zwei Stunden auftreten und zum Tode führen.

1. Halten Sie neue und gebrauchte Batterien von Kindern fern.
2. Wenn das Batteriefach nicht sicher schließt, dann benutzen Sie das Produkt nicht mehr und halten Sie es von Kindern fern.
3. Wenn Sie meinen, dass Batterien verschluckt wurden oder sich in irgendeinem Körperteil befinden, suchen Sie unverzüglich medizinische Hilfe auf.

Explosionsgefahr durch falschen Batterietyp

Das Einsetzen falscher Batterietypen kann zu einer Explosion führen.

- ❌ Verwenden Sie ausschließlich die in den technischen Daten spezifizierten Batterien.



VORSICHT

Feuergefahr durch Batterien

Die eingesetzten Batterien können bei Fehlbehandlung eine Feuer- oder Verbrennungsgefahr darstellen.

1. Versuchen Sie nicht, die Batterien aufzuladen, zu öffnen, zu erhitzen oder zu verbrennen.
2. Schließen Sie die Batterien nicht kurz.

ACHTUNG

Beschädigung durch elektrostatische Entladung (ESD) bei geöffnetem Gehäuse

Dieses Produkt enthält elektronische Bauteile, die durch elektrostatische Entladungen beschädigt werden können.

1. Verwenden Sie ESD-gerechte Arbeitsmaterialien (z.B. Erdungsarmband).
2. Erden Sie sich vor Arbeiten, bei denen Sie mit der Elektronik in Kontakt kommen könnten. Fassen Sie dazu geerdete metallische Oberflächen an (z.B. Türzargen, Wasserrohre oder Heizungsventile).

Beschädigung durch Öle, Fette, Farben und Säuren

Dieses Produkt enthält elektronische und/oder mechanische Bauteile, die durch Flüssigkeiten aller Art beschädigt werden können.

- ❌ Halten Sie Öle, Fette, Farben und Säuren vom Produkt fern.

Beschädigung durch aggressive Reinigungsmittel

Die Oberfläche dieses Produkts kann durch ungeeignete Reinigungsmittel beschädigt werden.

- ❌ Verwenden Sie ausschließlich Reinigungsmittel, die für Kunststoff- bzw. Metalloberflächen geeignet sind.

Beschädigung durch mechanische Einwirkung

Dieses Produkt enthält elektronische Bauteile, die durch mechanische Einwirkung aller Art beschädigt werden können.

1. Vermeiden Sie das Anfassen der Elektronik.
2. Vermeiden Sie sonstige mechanische Einwirkungen auf die Elektronik.

Beschädigung durch Verpolung

Dieses Produkt enthält elektronische Bauteile, die durch die Verpolung der Spannungsquelle beschädigt werden können.

- ❌ Verpolen Sie die Spannungsquelle nicht (Batterien bzw. Netzteile).

Störung des Betriebs durch Funkstörung

Dieses Produkt kann unter Umständen durch elektromagnetische oder magnetische Störungen beeinflusst werden.

- ❌ Montieren bzw. platzieren Sie das Produkt nicht unmittelbar neben Geräten, die elektromagnetische oder magnetische Störungen verursachen können (Schaltnetzteile!).

Störung der Kommunikation durch metallische Oberflächen

Dieses Produkt kommuniziert drahtlos. Metallische Oberflächen können die Reichweite des Produkts erheblich reduzieren.

- ❌ Montieren bzw. platzieren Sie das Produkt nicht auf oder in der Nähe von metallischen Oberflächen.



HINWEIS

Bestimmungsgemäßer Gebrauch

SimonsVoss-Produkte sind ausschließlich für das Öffnen und Schließen von Türen und vergleichbaren Gegenständen bestimmt.

- ❌ Verwenden Sie SimonsVoss-Produkte nicht für andere Zwecke.

Funktionsstörungen durch schlechten Kontakt oder unterschiedliche Entladung

Zu kleine/verunreinigte Kontaktfächen oder unterschiedliche entladene Batterien können zu Funktionsstörungen führen.

1. Verwenden Sie nur Batterien, die von SimonsVoss freigegeben sind.
2. Berühren Sie die Kontakte der neuen Batterien nicht mit den Händen.
3. Verwenden Sie saubere und fettfreie Handschuhe.
4. Tauschen Sie immer alle Batterien gleichzeitig aus.

Abweichende Zeiten bei G2-Schließungen

Die interne Zeiteinheit der G2-Schließungen hat eine technisch bedingte Toleranz von bis zu ± 15 Minuten pro Jahr.

Qualifikationen erforderlich

Die Installation und Inbetriebnahme setzt Fachkenntnisse voraus.

- ❌ Nur geschultes Fachpersonal darf das Produkt installieren und in Betrieb nehmen.

Änderungen bzw. technische Weiterentwicklungen können nicht ausgeschlossen und ohne Ankündigung umgesetzt werden.

Die deutsche Sprachfassung ist die Originalbetriebsanleitung. Andere Sprachen (Abfassung in der Vertragssprache) sind Übersetzungen der Originalbetriebsanleitung.

Lesen Sie alle Anweisungen zur Installation, zum Einbau und zur Inbetriebnahme und befolgen Sie diese. Geben Sie diese Anweisungen und jegliche Anweisungen zur Wartung an den Benutzer weiter.

3. Produktspezifische Sicherheitshinweise

ACHTUNG

Beschädigung durch Bohren

Sie bohren auf eigene Gefahr. Für Schäden, die durch das Bohren entstanden sind, haftet die SimonsVoss Technologies GmbH nicht.

- Beachten Sie auch die Sicherheitshinweise der Bohrmaschine.

Beschädigung durch ungeeignetes Werkzeug

Wenn Sie versuchen, das Gehäuse mit ungeeignetem Werkzeug zu öffnen, dann kann das Gehäuse beschädigt werden.

- Verwenden Sie nur das mitgelieferte SimonsVoss-Öffnungswerkzeug.

Verlust der präzisen Führung des Drückers

Die Montage kann bei Einsteckschlössern mit Klemmnuss schwergängig sein.

- Bearbeiten Sie die Klemmnuss nicht mechanisch. Der Drücker verliert dabei seine passgenaue Führung.

Erschwerte Montage durch ungenaue Bohrungen

Der Beschlag ist nicht montierbar, wenn die Befestigungsbohrungen und der Vierkant nicht zueinander passen.

- Stellen Sie sicher, dass die Linien der Befestigungsbohrungen und des Vierkants vertikal parallel sind.



HINWEIS

Verschluss der Rosettenöffnung

Eine ggfs. vorhandene Rosettenöffnung kann für Manipulationen genutzt werden.

1. Verschließen Sie ggfs. vorhandene Rosettenöffnungen, zum Beispiel mit einem Blindzylinder.
2. Bei FH-Varianten: Bauen Sie zwingend einen Blind- oder Schließzylinder aus Messing ein.

Wirkung auf das Einsteckschloss

Das SmartHandle AX wirkt ausschließlich auf die Falle des Einsteckschlusses.

Versicherungsrechtliches Verschließen

Versicherungen stellen erhöhte Anforderungen an eine Schließung.

1. Wenn Sie die Tür versicherungsrechtlich verschließen wollen, dann verwenden Sie ein selbstverriegelndes Panikschloss (SVP) oder zusätzlich zum SmartHandle AX einen Schließzylinder.
2. Achten Sie auf die Zulassungen nach EN 179.

SmartHandle mit selbstverriegelndem Panikschloss

Das SmartHandle AX bietet nur mit einem selbstverriegelndem Panikschloss die volle Funktionalität.

1. Kombinieren Sie das SmartHandle AX mit einem selbstverriegelndem Panikschloss (SVP).
2. Achten Sie auf die Konformitätserklärungen der Schlosshersteller nach EN 179.

Auflagen zur Berechtigungssicherheit

Der Betrieb mit Mifare Classic und/oder PinCode-Tastatur schließt die Berechtigungssicherheit Klasse D nach DIN EN 16867:2020 aus.

Dokumentation des Panikstangenherstellers

Beachten Sie auch die Dokumentation des Panikstangenherstellers (www.cisa.com bzw. www.g-u.com).

Vorgebogene Adapterplatte

Die Adapterplatte für den Beschlag ist vorgebogen. Die Vorspannung stellt nach der Montage den Kraftschluss zur Tür sicher.

Reserveschraube enthalten

Im Lieferumfang ist eine Reserveschraube enthalten.

- Verwenden Sie diese Reserveschraube, falls Sie eine Schraube zur Montage der Adapterplatte verloren haben.

4. Lieferumfang

- SmartHandle AX (Panikstangen-Version für CISA oder BKS)
- Spezialwerkzeug
- Kurzanleitung
- Blindzylinder

5. Aufbau CISA



6. Aufbau BKS



7. Tür für CISA vorbereiten (Bohrschablone)

- ✓ Stift oder Anreißnadel vorhanden.
- ✓ Bohrmaschine vorhanden.
- ✓ Geeignete Bohrer vorhanden (Ø6,5 mm und 8,0 mm).
- ✓ PH2-Schraubendreher vorhanden.
- ✓ Kegelsenker vorhanden.

1. Stecken Sie den Vierkant in das Einsteckschloss.



2. Stecken Sie die Bohrschablone auf den Vierkant.



3. Richten Sie die Bohrschablone mithilfe der aufgedruckten Skala senkrecht aus.

4. Markieren Sie die zu bohrenden Punkte auf der Tür.



5. Entfernen Sie die Bohrschablone.



6. Entfernen Sie den Vierkant.



7. Bauen Sie das Einsteckschloss aus (PH2).



8. Bohren Sie die benötigten Löcher.



9. Senken Sie das unterste Loch mit einem Kegelsenker an.



10. Bauen Sie das Einsteckschloss ein (PH2).



8. Tür für BKS vorbereiten (Bohrschablone)

- ✓ Stift oder Anreißnadel vorhanden.
- ✓ PH2-Schraubendreher vorhanden.
- ✓ Lineal vorhanden.
- ✓ Bohrmaschine vorhanden.
- ✓ Geeignete Bohrer vorhanden (Ø6,5 mm und 8,0 mm).

1. Bauen Sie das Einsteckschloss aus (PH2).



2. Messen Sie den vertikalen Abstand zwischen den Mittelpunkten der Befestigungslöcher.









3. Bauen Sie das Einsteckschloss ein (PH2).



4. Stecken Sie den Vierkant in das Einsteckschloss.



5. Stecken Sie die Bohrschablone auf den Vierkant.  4
6. Richten Sie die Bohrschablone mithilfe der aufgedruckten Skala senkrecht aus.
7. Bestimmen Sie die zu bohrenden Punkte mithilfe des vorher gemessenen Abstands.
8. Markieren Sie die zu bohrenden Punkte auf der Tür.  17
9. Entfernen Sie die Bohrschablone.  6
10. Entfernen Sie den Vierkant.  19
11. Bauen Sie das Einsteckschloss aus (PH2).  20
12. Bohren Sie die benötigten Löcher.  21
13. Bauen Sie das Einsteckschloss ein (PH2).  22











9. Beschlag programmieren



Programmieren Sie den Beschlag vor der Montage. Je nach Produktfamilie können Sie verschiedene Programmiergeräte verwenden.

-  23
-  24
-  25

10. Beschlag für CISA montieren

- ✓ Tür vorgebohrt.
- ✓ PH2-Schraubendreher vorhanden.
- ✓ TX15-Schraubendreher vorhanden.
- ✓ Messschieber vorhanden.
- ✓ Säge vorhanden.

1. Messen Sie die Türdicke.  26
2. Markieren Sie die Sägestellen an den Schrauben und am Vierkant.  27  28
3. Kürzen Sie mit einer geeigneten Säge die Schrauben und den Vierkant.  29
4. Setzen Sie die Hülsenmutter in die Adapterplatte ein.  30
5. Legen Sie die Adapterplatte auf den elektronischen Beschlag.  31
6. Richten Sie Löcher in der Adapterplatte auf die Gewinde im Beschlag aus.
7. Schrauben Sie die Adapterplatte überkreuz fest (PH2, Drehmoment: 1,1 Nm).  32  33
8. Stecken Sie den Vierkant mit der Pin-Seite in den Beschlag.  34
9. Stecken Sie den Beschlag mit Adapterplatte und Vierkant in die Tür.  35
10. Schrauben Sie den Beschlag in der Mitte fest (PH2, Drehmoment 1,1 Nm).  36

11. Schrauben Sie die Adapterplatte auch unterhalb des Schlüssellochs fest (PH2, Drehmoment: 1,1 Nm).  37
12. Schrauben Sie wie in der CISA-Dokumentation beschrieben die Holzschraube fest.  38
13. Setzen Sie den Blindzylinder ein.







HINWEIS

Blindzylinder mit Schraubendreher im Loch führen

Insbesondere bei dicken Türen ist es schwierig, den Blindzylinder richtig zu positionieren.











1. Stecken Sie einen Schraubendreher in das Loch des Blindzylinders.
2. Positionieren Sie den Blindzylinder mithilfe des Schraubendrehers.





-  39
-  40
14. Stecken Sie den Drücker auf den Außenbeschlag.  41
15. Schrauben Sie die Madenschraube des Außendrückers fest (TX15, Drehmoment: 5,0 Nm).  42
16. Schrauben Sie den Blindzylinder fest (PH2, Drehmoment: 1,1 Nm).  43

↳ Beschlag ist fertig montiert.

11. Beschlag für BKS montieren

- ✓ Tür vorgebohrt.
- ✓ PH2-Schraubendreher vorhanden.
- ✓ TX15-Schraubendreher vorhanden.
- ✓ Messschieber vorhanden.
- ✓ Säge vorhanden.

1. Messen Sie die Türdicke.  26
2. Bestellen Sie die L1-Schraube in der passenden Länge bei BKS.  45  46
3. Markieren Sie die Sägestellen an den L2-Schrauben.  47
4. Bestimmen Sie je nach Art der Panikstange die Länge X.  48
5. Markieren Sie die Sägestelle am Vierkant.  49
6. Kürzen Sie mit einer geeigneten Säge die Schrauben und den Vierkant.  50
7. Setzen Sie die Hülsenmutter in die Adapterplatte ein.  30
8. Legen Sie die Adapterplatte auf den elektronischen Beschlag.  31
9. Richten Sie Löcher in der Adapterplatte auf die Gewinde im Beschlag aus.
10. Schrauben Sie die Adapterplatte überkreuz fest (PH2, Drehmoment: 1,1 Nm).  32  33

11. Stecken Sie den Vierkant mit der Pin-Seite in den Beschlag.
 34
12. Stecken Sie den Beschlag mit Adapterplatte, Vierkant und Rosettenbasis in die Tür.
 56
13. Schrauben Sie den Beschlag wie in der BKS-Dokumentation beschrieben in der Mitte fest (Verwenden Sie die bei BKS bestellte L1-Schraube und die Holzschraube).
 57
14. Schrauben Sie die Rosettenbasis an der Baugruppe mit den L2-Schrauben fest (PH2, Drehmoment: 1,1 Nm).
 58
15. Setzen Sie den Blindzylinder ein.







HINWEIS

Blindzylinder mit Schraubendreher im Loch führen

Insbesondere bei dicken Türen ist es schwierig, den Blindzylinder richtig zu positionieren.



1. Stecken Sie einen Schraubendreher in das Loch des Blindzylinders.
2. Positionieren Sie den Blindzylinder mithilfe des Schraubendrehers.

-  39
16. Stecken Sie die Rosettenblende auf die Rosettenbasis.
 60
17. Stecken Sie den Drücker auf den Außenbeschlag.
 61
18. Schrauben Sie die Madenschraube des Außendrückers fest (TX15, Drehmoment: 5,0 Nm).
 62
19. Schrauben Sie den Blindzylinder fest (PH2, Drehmoment: 1,1 Nm).
 63

↳ Beschlag ist fertig montiert.

12. Beschlag demontieren

✓ 1,5-mm-Sechskantschlüssel vorhanden.

1. Demontieren Sie den Beschlag in umgekehrter Reihenfolge zur Montage.
2. Stecken Sie einen 1,5-mm-Sechskantschlüssel in das Loch der Vierkantaufnahme im Beschlag.
 64
3. Biegen Sie den Sechskantschlüssel auf die Seite, auf der sich das Loch befindet und ziehen Sie gleichzeitig am Außendrücker.
 65

↳ Beschlag ist demontiert.

13. Batterien wechseln















HINWEIS

Funktionsstörungen durch schlechten Kontakt oder unterschiedliche Entladung

Zu kleine/verunreinigte Kontaktfächen oder unterschiedliche entladene Batterien können zu Funktionsstörungen führen.

1. Verwenden Sie nur Batterien, die von SimonsVoss freigegeben sind.
2. Berühren Sie die Kontakte der neuen Batterien nicht mit den Händen.
3. Verwenden Sie saubere und fettfreie Handschuhe.
4. Tauschen Sie immer alle Batterien gleichzeitig aus.

- ✓ Spezialwerkzeug ist vorhanden.
- ✓ Handschuhe vorhanden.

1. Stecken Sie das Spezialwerkzeug in das Cover-Inlay des Beschlags.
 66
 2. Nehmen Sie das Cover mit dem Werkzeug ab.
 67
 68
 3. Biegen Sie die Batterieklemmer vorsichtig nach innen, um sie auszuheben.
 69
 70
 4. Öffnen Sie die Batterieklemmer.
 71
 5. Ziehen Sie die Batterieklemmer heraus.
 72
 6. Entnehmen Sie die alten Batterien.
 73
 7. Setzen Sie die neuen Batterien mit sich berührenden Pluspolen ein (Typ CR2450).
 74
 8. Setzen Sie die Batterieklemmer wieder ein.
 75
 9. Haken Sie die Batterie-Klemmer wieder ein.
 76
 10. Stecken Sie das Cover wieder auf den Beschlag.
 77
 11. Klipsen Sie das Cover wieder fest.
 78
- ↳ Batterien sind gewechselt.

14. Technische Daten

Temperaturbereich (Betrieb)	-25 °C bis +50 °C
Batterietyp	4 × CR2450 (3V)
Batteriehersteller	<ul style="list-style-type: none"> ■ Murata ■ Varta ■ Panasonic
IP-Schutzklasse	IP40

Funkemissionen

15,24 kHz - 72,03 kHz Nur für Artikelnummern: SV-S2.*A*, SV-S2.*AM*, SV-S2.*LN*	10 dBµA/m (3 m Entfernung)
13,5600006 MHz - 13,560780 MHz	1,04 dBµA/m (3 m Entfernung)
868,000 MHz - 868,600 MHz / 869,700 MHz - 870,000 MHz Nur für Artikelnummern: SV-S2.*LN*, SI-S2.*M.WO*	<25 mW ERP
2402 MHz - 2480 MHz	2,5 mW

15. Konformitätserklärung

Hiermit erklärt die SimonsVoss Technologies GmbH., dass die Artikel (SV-S2.*A*, SV-S2.*AM*, SV-S2.*LN*, SI-S2.*M.WO*, SI-S2.*M.VCN*) folgenden Richtlinien entsprechen:

- 2014/53/EU - Funkanlagen- bzw. für UK: Rechtsverordnung 2017 Nr. 1206 -Funkanlagen-
- 2011/65/EU -RoHS- bzw. für UK: Rechtsverordnung 2012 Nr. 3032 -RoHS-



Der vollständige Text der EU-Konformitätserklärung ist unter der folgenden Internetadresse verfügbar: www.simons-voss.com/de/zertifikate.html.

Der vollständige Text der UK-Konformitätserklärung ist unter der folgenden Internetadresse verfügbar: www.simons-voss.com/de/zertifikate.html.

16. Hilfe und weitere Informationen

Infomaterial/Dokumente

<https://www.simons-voss.com/de/dokumente.html>

<https://www.smartintego.com/de/home/infocenter/dokumentation>

Konformitätserklärungen und Zertifikate

<https://www.simons-voss.com/de/zertifikate.html>

Informationen zur Entsorgung

- Entsorgen Sie das Gerät (SV-S2.*A*, SV-S2.*AM*, SV-S2.*LN*, SI-S2.*M.WO*, SI-S2.*M.VCN*) nicht mit dem Hausmüll, sondern gemäß der europäischen Richtlinie 2012/19/EU bei einer kommunalen Sammelstelle für Elektro-Sonderabfälle.
- Recyceln Sie defekte oder verbrauchte Batterien gemäß der europäischen Richtlinie 2006/66/EG.
- Beachten Sie örtliche Bestimmungen zur getrennten Entsorgung von Batterien.
- Führen Sie die Verpackung einer umweltgerechten Wiederverwertung zu.



79

E-Mail

support-simonsvoss@allegion.com

si-support-simonsvoss@allegion.com

SimonsVoss Technologies GmbH, Feringastr. 4, D-85774 Unterfoehring, Deutschland

1. Intended use

Products in the SmartHandle AX range consist of electronic door fittings. Users can engage SmartHandle AX and open the door onto which it is fitted with an authorised ID medium, such as a transponder.

The corresponding authorisations need to be issued using an electronic locking plan.

Products in the SmartHandle AX range may only be used for locking and unlocking doors. No other use is permitted.

2. General safety instructions

Signal word: Possible immediate effects of non-compliance

WARNING: Death or serious injury (possible, but unlikely), CAUTION: Minor injury, IMPORTANT: Property damage or malfunction, NOTE: Low or none



WARNING

Blocked access

Access through a door may stay blocked due to incorrectly fitted and/or incorrectly programmed components. SimonsVoss Technologies GmbH is not liable for the consequences of blocked access such as access to injured or endangered persons, material damage or other damage!

Blocked access through manipulation of the product

If you change the product on your own, malfunctions can occur and access through a door can be blocked.

- Modify the product only when needed and only in the manner described in the documentation.

Do not swallow battery. Danger of burns from hazardous substances

This product contains lithium button cell batteries. Swallowing the button cell battery, in can result in severe internal burns leading to death in as little as two hours.

1. Keep new and used batteries away from children.
2. If the battery compartment does not close securely, cease using the product and keep it away from children.
3. If you think batteries have been swallowed or are in any part of the body, seek medical attention immediately.

Risk of explosion due to incorrect battery type

Inserting the wrong type of battery can cause an explosion.

- Only use the batteries specified in the technical data.



CAUTION

Fire hazard posed by batteries

The batteries used may pose a fire or burn hazard if handled incorrectly.

1. Do not try to charge, open, heat or burn the batteries.
2. Do not short-circuit the batteries.

IMPORTANT

Damage resulting from electrostatic discharge (ESD) when enclosure is open

This product contains electronic components that may be damaged by electrostatic discharges.

1. Use ESD-compliant working materials (e.g. Grounding strap).
2. Ground yourself before carrying out any work that could bring you into contact with the electronics. For this purpose, touch earthed metallic surfaces (e.g. door frames, water pipes or heating valves).

Damage resulting from liquids

This product contains electronic and/or mechanic components that may be damaged by liquids of any kind.

- Keep liquids away from the electronics.

Damage resulting from aggressive cleaning agents

The surface of this product may be damaged as a result of the use of unsuitable cleaning agents.

- Only use cleaning agents that are suitable for plastic or metal surfaces.

Damage as a result of mechanical impact

This product contains electronic components that may be damaged by mechanical impacts of any kind.

1. Avoid touching the electronics.
2. Avoid other mechanical influences on the electronics.

Damage due to polarity reversal

This product contains electronic components that may be damaged by reverse polarity of the power source.

- Do not reverse the polarity of the voltage source (batteries or mains adapters).

Operational malfunction due to radio interference

This product may be affected by electromagnetic or magnetic interference.

- Do not mount or place the product directly next to devices that could cause electromagnetic or magnetic interference (switching power supplies!).

Communication interference due to metallic surfaces

This product communicates wirelessly. Metallic surfaces can greatly reduce the range of the product.

- Do not mount or place the product on or near metallic surfaces.



NOTE

Intended use

SimonsVoss-products are designed exclusively for opening and closing doors and similar objects.

- Do not use SimonsVoss products for any other purposes.

Malfunctions due to poor contact or different discharge

Contact surfaces that are too small/contaminated or different discharged batteries can lead to malfunctions.

1. Only use batteries that are approved by SimonsVoss.
2. Do not touch the contacts of the new batteries with your hands.
3. Use clean and grease-free gloves.
4. Always replace all batteries at the same time.

Different times for G2 locks

The internal time unit of the G2 locks has a technical tolerance of up to ± 15 minutes per year.

Qualifications required

The installation and commissioning requires specialized knowledge.

- Only trained personnel may install and commission the product.

Modifications or further technical developments cannot be excluded and may be implemented without notice.

The German language version is the original instruction manual. Other languages (drafting in the contract language) are translations of the original instructions.

Read and follow all installation, installation, and commissioning instructions. Pass these instructions and any maintenance instructions to the user.

3. Product-specific safety instructions

IMPORTANT

Damage by drilling

You drill at your own risk. SimonsVoss Technologies GmbH is not liable for damage caused by drilling.

- Please also observe the safety instructions of the drilling machine.

Damage caused by unsuitable tools

If you try to open the case with unsuitable tools, the case may be damaged.

- Use only the supplied SimonsVoss opening tool.

Loss of the precise guidance of the handle

It may be difficult to install on mortise locks with a retaining nut.

- Do not mechanically alter the locking nut. The handle would then lose its precise guidance.

Difficult installation due to inaccurate holes

The fitting cannot be installed if the fastening holes and the spindle do not match.

- Make sure that the fastening holes and the spindle are in parallel vertical lines.

**NOTE****Sealing escutcheon holes**

Any escutcheon holes that exist may be used to manipulate the lock.

- Seal any escutcheon holes with a blind cylinder, for example.
- In the case of FH versions, you must install a brass dummy cylinder or locking cylinder.

Effect on the mortise lock

The SmartHandle AX acts exclusively on the latch of the mortise lock.

Locking and insurances

Insurance companies place increased demands on a closure.

- If you want to lock the door under insurance law, use a self-locking panic lock or a locking cylinder in addition to the SmartHandle AX.
- Pay attention to the approvals according to EN 179.

SmartHandle AX with self-locking panic lock

The SmartHandle AX only offers full functionality with a self-locking panic lock.

- Combine the SmartHandle AX with a self-locking panic lock.
- Pay attention to the declarations of conformity of the lock manufacturers according to EN 179.

Conditions for authorisation security

Operation with Mifare Classic and/or PinCode keypad excludes authorisation security class D according to DIN EN 16867:2020.

Panic bar manufacturer's documentation

Also observe the panic bar manufacturer's documentation (www.cisa.com or www.g-u.com).

Pre-bent adapter plate

The adapter plate for the fitting is pre-bent. Its pre-tensioning ensures a frictional connection with the door after installation.

Spare screw included

A spare screw is included in the delivery.

- Use this spare screw if you have lost a screw to fit the adapter plate.

4. Scope of delivery

- SmartHandle AX (Panic bar version for CISA or BKS)
- Special tool
- Quick guide
- Blank cylinder

5. CISA design

1

6. BKS design

2

7. Preparing the door for CISA (drilling template)

- Pin or scriber at hand.
- Drill at hand.

- Suitable drill bits at hand (Ø6.5 mm and 8.0 mm).
- PH2 screwdriver at hand.
- Countersink at hand.

- Insert the spindle into the mortise lock.



3

- Place the drilling template on the spindle.



4

- Align the drill template vertically using the printed scale.

- Mark the points to be drilled on the door.



5

- Remove the drilling template.



6

- Remove the spindle.



7

- Remove the mortise lock (PH2).



8

- Drill the required holes.



9

- Countersink the lowest hole with a countersink.



10

- Fit the mortise lock (PH2).



11

8. Preparing the door for BKS (drilling template)

- Pin or scriber at hand.
- PH2 screwdriver at hand.
- Ruler at hand.
- Drill at hand.
- Suitable drill bits at hand (Ø6.5 mm and 8.0 mm).

- Remove the mortise lock (PH2).



12

- Measure the vertical distance between the centres of the fixing holes.



13

- Fit the mortise lock (PH2).



14

- Insert the spindle into the mortise lock.



15

- Place the drilling template on the spindle.



16

- Align the drill template vertically using the printed scale.

- Use the distance you measured previously to determine where the points need to be drilled.

- Mark the points to be drilled on the door.



17

- Remove the drilling template.



18

- Remove the spindle.



19

- Remove the mortise lock (PH2).



20

- Drill the required holes.



21

- Fit the mortise lock (PH2).



22

9. Programming the fitting

Programme the fitting before installation. You can use different programming devices, depending on the product family.



23



24



25

10. Installing the fitting for CISA

- ✓ Door pre-drilled.
- ✓ PH2 screwdriver at hand.
- ✓ TX15 screwdriver at hand.
- ✓ Vernier calliper at hand.
- ✓ Saw at hand.

1. Measure the door thickness.



26

2. Mark the sawing points on the screws and spindle.



27



28

3. Use a suitable saw to cut the screws and spindle.



29

4. Insert the sleeve nuts into the adapter plate.



30

5. Place the adapter plate on the electronic fitting.



31

6. Align the holes in the adapter plate with the threads in the fitting.

7. Fasten the adapter plate firmly in a criss-cross sequence (PH2, torque 1.1 Nm).



32



33

8. Insert the spindle with the pin side into the fitting.



34

9. Insert the fitting with the adapter plate and spindle into the door.



35

10. Screw the fitting firmly into place in the centre (PH2, torque 1.1 Nm).



36

11. Screw the adapter plate firmly into place below the keyhole (PH2, torque 1.1 Nm).



37

12. Fasten the wood screw as described in the CISA documentation.



38

13. Insert the dummy cylinder.



NOTE

Feed the blank cylinder into the hole using a screwdriver

It is difficult to position the blank cylinder correctly, especially in thick doors.

1. Insert a screwdriver into the hole in the blank cylinder.
2. Position the blank cylinder using the screwdriver.



39



40

14. Push the handle onto the outer fitting.



41

15. Firmly fasten the grub screw on the outside handle (TX15; torque: 5.0 Nm).



42

16. Screw the dummy cylinder firmly into place (PH2, torque 1.1 Nm).



43

- ↳ Fitting is now installed.

11. Installing the fitting for BKS

- ✓ Door pre-drilled.
- ✓ PH2 screwdriver at hand.
- ✓ TX15 screwdriver at hand.
- ✓ Vernier calliper at hand.
- ✓ Saw at hand.

1. Measure the door thickness.



26

2. Order the L1 screw of the appropriate length from BKS.



45



46

3. Mark the sawing points on the L2 screws.



47

4. Determine the length X, depending on the panic bar type.



48

5. Mark the sawing point on the spindle.



49

6. Use a suitable saw to cut the screws and spindle.



50

7. Insert the sleeve nuts into the adapter plate.



30

8. Place the adapter plate on the electronic fitting.



31

9. Align the holes in the adapter plate with the threads in the fitting.

10. Fasten the adapter plate firmly in a criss-cross sequence (PH2, torque 1.1 Nm).



32



33

11. Insert the spindle with the pin side into the fitting.



34

12. Insert the fitting with adapter plate, spindle and escutcheon base into the door.



56

13. Screw the fitting into place in the centre as described in the BKS documentation (use the L1 screw and the wood screw ordered from BKS).



57

14. Screw the escutcheon base to the assembly using the L2 screws (PH2, torque: 1.1 Nm).



58

15. Insert the dummy cylinder.



NOTE





Feed the blank cylinder into the hole using a screwdriver

It is difficult to position the blank cylinder correctly, especially in thick doors.



1. Insert a screwdriver into the hole in the blank cylinder.
2. Position the blank cylinder using the screwdriver.



39

16. Place the escutcheon cover on the escutcheon base.
 60
 17. Push the handle onto the outer fitting.
 61
 18. Firmly fasten the grub screw on the outside handle (TX15; torque: 5.0 Nm).
 62
 19. Screw the dummy cylinder firmly into place (PH2, torque 1.1 Nm).
 63
- ↳ Fitting is now installed.

12. Removing the fitting

- ✓ 1.5 mm hexagonal wrench available.
1. Remove the fitting in the reverse order to installation.
 2. Insert a 1.5 mm hex key into the hole in the spindle mount in the fitting.
 64
 3. Bend the hex key to the side where the hole is located while pulling on the outside handle.
 65
- ↳ Fitting is now removed.

13. Replacing the batteries













NOTE

Malfunctions due to poor contact or different discharge

Contact surfaces that are too small/contaminated or different discharged batteries can lead to malfunctions.

1. Only use batteries that are approved by SimonsVoss.
2. Do not touch the contacts of the new batteries with your hands.
3. Use clean and grease-free gloves.
4. Always replace all batteries at the same time.

- ✓ Special tool at hand.
- ✓ Gloves at hand.

1. Insert the special tool into the fitting's cover inlay.
 66
2. Remove the cover with the tool.
 67
 68
3. Carefully bend the battery clip inwards to detach it.
 69
 70
4. Open the battery holder.
 71
5. Remove the battery holder.
 72
6. Remove the old batteries.
 73
7. Insert the new batteries with the positive terminals next to each other (type CR2450).
 74
8. Put the battery holder back into place.
 75
9. Reattach the battery clip.
 76

10. Replace the cover on the fitting.
 77
 11. Snap the cover back into place.
 78
- ↳ Batteries are now replaced.

14. Technical data

Operating temperature range	-25 °C to +50 °C
Battery type	4x CR2450 (3V)
Battery manufacturer	<ul style="list-style-type: none"> ■ Murata ■ Varta ■ Panasonic
IP protection rating	IP40

Radio emissions

15.24 kHz - 72.03 kHz Only for item numbers: SV-S2.*A*, SV-S2.*AM*, SV-S2.*LN*	10 dBµA/m (3 m distance)
13.560006 MHz - 13.560780 MHz	1.04 dBµA/m (3 m distance)
868.000 MHz - 868.600 MHz / 869.700 MHz - 870.000 MHz Only for item numbers: SV-S2.*LN*, SI-S2.*M.WO*	<25 mW ERP
2402 MHz - 2480 MHz	2.5 mW

15. Declaration of conformity

The company SimonsVoss Technologies GmbH hereby declares that the articles (SV-S2.*A*, SV-S2.*AM*, SV-S2.*LN*, SI-S2.*M.WO*, SI-S2.*M.VCN*) comply with the following guidelines:

- 2014/53/EU -RED-
or for the UK: UK statutory 2017 No. 1206 -Radio equipment-
- 2011/65/EU -RoHS-
or for the UK: UK statutory 2012 No. 3032 -RoHS-



The full text of the EU Declaration of conformity is available at the following internet address: www.simons-voss.com/en/certificates.html.
The full text of the UK Declaration of conformity is available at the following internet address: www.simons-voss.com/en/certificates.html.

16. Help and other information

Information material/documents

<https://www.simons-voss.com/en/documents.html>
<https://www.smartintego.com/int/home/infocenter/documentation>

Declarations of conformity

<https://www.simons-voss.com/en/certificates.html>

Information on disposal

- Do not dispose the device (SV-S2.*A*, SV-S2.*AM*, SV-S2.*LN*, SI-S2.*M.WO*, SI-S2.*M.VCN*) in the household waste. Dispose of it at a collection point for electronic waste as per European Directive 2012/19/EU.
- Recycle defective or used batteries in line with European Directive 2006/66/EC.
- Observe local regulations on separate disposal of batteries.
- Take the packaging to an environmentally responsible recycling point.



Email

support-simonsvoss@allegion.com
si-support-simonsvoss@allegion.com

SimonsVoss Technologies GmbH, Feringastr. 4, D-85774 Unterfoehring,
Germany

1. Utilisation conforme

Les produits de la série SmartHandle AX sont des béquilles électroniques. Au moyen d'un support d'identification autorisé, la SmartHandle AX peut réaliser un accouplement ou ouvrir la porte correspondante.

Les autorisations correspondantes doivent être accordées au moyen d'un plan de fermeture électronique.

Les produits de la série SmartHandle AX ne doivent servir qu'à ouvrir et fermer des portes. Toute autre utilisation est interdite.

2. Consignes de sécurité générales

Mot indicateur: Effets immédiats possibles du non-respect

AVERTISSEMENT: Mort ou blessure grave (possible, mais improbable), PRU-

DENCE: Blessure légère, ATTENTION: Dommages matériels ou dysfonctionnements, NOTE: Peu ou pas



AVERTISSEMENT

Accès bloqué

Toute erreur de montage et/ou de programmation d'un composant peut bloquer l'accès par une porte. La société SimonsVoss Technologies GmbH décline toute responsabilité quant aux conséquences d'un accès bloqué, par exemple, accès pour les personnes blessées ou en danger, dommages matériels ou autres dommages !

Accès bloqué par la manipulation du produit

Si vous modifiez vous-même le produit, des dysfonctionnements peuvent se produire et l'accès peut être bloqué par une porte.

- Ne changer le produit que lorsque cela est nécessaire et de la manière décrite dans la documentation.

Ne pas saisir la pile. Risque de brûlures dues à des substances dangereuses

Ce produit contient des piles au lithium. En cas d'ingestion de la pile, de graves brûlures internes peuvent se produire sous deux heures et entraîner la mort.

- Conservez les piles neuves et usagées hors de portée des enfants.
- Si le compartiment à piles ne ferme pas correctement, cessez d'utiliser le produit et conservez-le hors de portée des enfants.
- En cas de suspicion d'ingestion des piles ou si celles-ci se trouvent dans une partie quelconque de votre corps, consultez immédiatement un médecin.

Risque d'explosion dû à un type de batterie incorrect

L'insertion d'un mauvais type de batterie peut provoquer une explosion.

- Utilisez uniquement les piles indiquées dans les données techniques.



PRUDENCE

Risque d'incendie dû aux piles

En cas de manipulation impropre, les piles insérées peuvent provoquer un incendie ou des brûlures.

- Ne jamais essayer de recharger les piles, de les ouvrir, de les chauffer ou de les brûler.
- Ne pas court-circuiter les piles.

ATTENTION

Endommagement lié à une décharge électrostatique (DES) lorsque le boîtier est ouvert

Ce produit contient des composants électroniques susceptibles d'être endommagés par des décharges électrostatiques.

- Utilisez du matériel de travail adapté à la DES (par ex. un bracelet de mise à la terre).
- Reliez-vous à la terre avant de commencer les travaux pendant lesquels vous pouvez être en contact avec le système électronique. Saisissez pour cela des surfaces métalliques mises à la terre (par ex. huisseries de porte, conduites d'eau ou vannes de chauffage).

Endommagement lié à des liquides

Ce produit contient des composants électroniques et/ou mécaniques susceptibles d'être endommagés par tout type de liquide.

- Tenez les liquides à l'écart du système électronique.

Endommagement lié à des nettoyeurs agressifs

La surface de ce produit peut être endommagée par des nettoyeurs inappropriés.

- Utilisez exclusivement des nettoyeurs adaptés aux surfaces plastiques ou métalliques.

Endommagement lié à une action mécanique

Ce produit contient des composants électroniques susceptibles d'être endommagés par une action mécanique quelconque.

- Évitez de toucher le système électronique.
- Évitez toute autre action mécanique sur le système électronique.

Endommagement lié à une inversion de polarité

Ce produit contient des composants électroniques susceptibles d'être endommagés par une inversion de polarité de la source de tension.

- N'inversez pas la polarité de la source de tension (piles ou blocs d'alimentation).

Défaillance du fonctionnement liée à une perturbation radioélectrique

Dans certaines circonstances, ce produit peut subir l'influence de perturbations électromagnétiques ou magnétiques.

- Ne montez pas et ne placez pas le produit à proximité immédiate d'appareils pouvant générer des perturbations électromagnétiques ou magnétiques (alimentations à découpage !).

Défaillance de la communication liée à des surfaces métalliques

Ce produit communique sans fil. Les surfaces métalliques peuvent réduire considérablement le rayon d'action du produit.

- Ne montez pas et ne placez pas le produit sur ou à proximité de surfaces métalliques.



NOTE

Utilisation conforme aux dispositions

Les produits SimonsVoss sont exclusivement destinés à l'ouverture et la fermeture de portes et d'objets similaires.

- N'utilisez pas les produits SimonsVoss à d'autres fins.

Horaires différents pour les fermetures G2

L'unité de temps interne des fermetures G2 présente une tolérance technique pouvant atteindre ± 15 minutes par an.

Qualifications requises

L'installation et la mise en service nécessitent des connaissances spécialisées.

- Seul le personnel qualifié peut installer et mettre en service le produit.

Dysfonctionnements dus à un mauvais contact ou à une décharge différée

Des surfaces de contact trop petites/contaminées ou différentes batteries déchargées peuvent entraîner des dysfonctionnements.

- Utilisez uniquement des piles autorisées par la société SimonsVoss.
- Ne touchez pas les contacts des piles neuves avec les mains.
- Utilisez des gants propres et exempts de graisse.
- Remplacez toujours toutes les piles à la fois.

Les modifications et nouveaux développements techniques ne peuvent pas être exclus et peuvent être mis en œuvre sans préavis.

La version allemande est le manuel d'instruction original. Les autres langues (rédaction dans la langue du contrat) sont des traductions des instructions originales.

Lisez et suivez toutes les instructions d'installation, d'installation et de mise en service. Transmettez ces instructions et toutes les instructions de maintenance à l'utilisateur.

3. Consignes de sécurité spécifiques au produit

ATTENTION

Dommages causés par le perçage

Vous percez à vos risques et périls. SimonsVoss Technologies GmbH n'est pas responsable des dommages causés par le forage.

- Respectez également les consignes de sécurité de la perceuse.

Dommages causés par des outils inadaptés

Si vous essayez d'ouvrir le boîtier avec des outils inappropriés, le boîtier peut être endommagé.

- Utilisez uniquement l'outil d'ouverture SimonsVoss fourni.

Perte de précision du guidage de la poignée

Dans le cas de serrures encastrées avec douille de serrage, le montage peut être difficile.

- N'insérez pas la douille de serrage mécaniquement. Le guidage de la poignée perd de sa précision.

Montage difficile en raison de perçages imprécis

La ferrure ne peut pas être montée si les perçages de fixation et le carré ne concordent pas.

- Assurez-vous que les lignes des perçages de fixation et du carré sont parallèles verticalement.



NOTE

Fermeture de l'ouverture de la rosace

Une ouverture de rosace éventuellement existante peut être utilisée pour des manipulations.

- Fermez le cas échéant les ouvertures de rosace existantes, par exemple avec un cylindre borgne.
- Pour les variantes FH : Installez impérativement un cylindre borgne ou un cylindre de fermeture en laiton.

Effet sur la serrure à mortaiser

La SmartHandle AX agit exclusivement sur le loquet de la serrure à mortaiser.

Verrouillage en vertu du droit des assurances

Les compagnies d'assurance exigent de plus en plus une fermeture.

- Si vous souhaitez verrouiller la porte en vertu du droit des assurances, utilisez une serrure antipanique autobloquante ou un cylindre de fermeture en plus de la SmartHandle AX.
- Respecter les homologations selon EN 179.

SmartHandle avec serrure antipanique autobloquante

Le SmartHandle AX offre uniquement une fonctionnalité complète avec une serrure antipanique autobloquante.

- Combinez la SmartHandle AX avec une serrure anti-panique autobloquante.
- Respecter les déclarations de conformité des fabricants de serrures selon EN 179.

Obligations relatives à la sécurité d'autorisation

Le fonctionnement avec Mifare Classic et/ou clavier PinCode exclut la sécurité d'autorisation de classe D selon DIN EN 16867:2020.

Documentation du fabricant de la barre anti-panique

Tenez également compte de la documentation du fabricant de la barre anti-panique (www.cisa.com ou www.g-u.com).

Plaque d'adaptation précintrée

La plaque d'adaptation pour la ferrure est précintrée. La précontrainte assure l'adhérence à la porte après le montage.

Vis de rechange incluse

Une vis de rechange est fournie.

- Utilisez cette vis de rechange en cas de perte d'une vis pour le montage de la plaque d'adaptation.

4. Contenu de la livraison

- SmartHandle AX (version barre anti-panique pour CISA ou BKS)
- Outil spécial
- Notice abrégée
- Cylindre borgne

5. Construction CISA



6. Construction BKS



7. Préparation de la porte pour CISA (gabarit de perçage)

- Stylo ou pointe à tracer présent.
- Perceuse présente.
- Des forets appropriés sont disponibles (Ø6,5 mm et 8,0 mm).
- Tournevis PH2 présent.
- Chanfrein conique présent.

- Insérez le carré dans la serrure à mortaiser.



- Placez le gabarit de perçage sur le carré.



- Alignez le gabarit de perçage verticalement à l'aide de l'échelle imprimée.

- Marquez les points à percer sur la porte.



- Enlevez le gabarit de perçage.



- Enlevez le carré.



- Démontez la serrure à mortaise (PH2).



- Percez les trous nécessaires.



- Chanfreinez le trou le plus bas à l'aide d'un chanfrein conique.



- Montez la serrure à mortaise (PH2).



8. Préparation de la porte pour BKS (gabarit de perçage)









- Stylo ou pointe à tracer présent.
- Tournevis PH2 présent.
- Règle présente.
- Perceuse présente.
- Des forets appropriés sont disponibles (Ø6,5 mm et 8,0 mm).

- Démontez la serrure à mortaise (PH2).



- Mesurez la distance verticale entre les centres des trous de fixation.



3. Montez la serrure à mortaise (PH2).
 14
4. Insérez le carré dans la serrure à mortaise.
 3
5. Placez le gabarit de perçage sur le carré.
 4
6. Alignez le gabarit de perçage verticalement à l'aide de l'échelle imprimée.
7. Déterminez les points à percer à l'aide de la distance mesurée précédemment.
8. Marquez les points à percer sur la porte.
 17
9. Enlevez le gabarit de perçage.
 6
10. Enlevez le carré.
 19
11. Démontez la serrure à mortaise (PH2).
 20
12. Percez les trous nécessaires.
 21
13. Montez la serrure à mortaise (PH2).
 22











9. Programmation de la ferrure



Programmez la ferrure avant le montage. En fonction de la famille de produits, vous pouvez utiliser différents appareils de programmation.



10. Montage de la ferrure pour CISA

- ✓ Porte prépercée.
- ✓ Tournevis PH2 présent.
- ✓ Tournevis TX15 présent.
- ✓ Pied à coulisse présent.
- ✓ Scie disponible.

1. Mesurez l'épaisseur de la porte.
 26
2. Marquez les cadres de sciage sur les vis et le carré.
 27
 28
3. Raccourcissez les vis et le carré à l'aide d'une scie appropriée.
 29
4. Insérez l'écrou à manchon dans la plaque d'adaptation.
 30
5. Placez la plaque d'adaptation sur la ferrure électronique.
 31
6. Alignez les trous de la plaque d'adaptation avec les filetages de la ferrure.
 32
7. Vissez la plaque d'adaptation en croix (PH2, couple : 1,1 Nm).
 33
8. Insérez le carré avec le côté broche dans la ferrure.
 34
9. Insérer la ferrure avec la plaque d'adaptation et le carré dans la porte.
 35

10. Vissez la ferrure au milieu (PH2, couple 1,1 Nm).
 36
11. Vissez également la plaque d'adaptation sous le trou de serrure (PH2, couple : 1,1 Nm).
 37
12. Vissez la vis à bois comme décrit dans la documentation CISA.
 38
13. Insérez le cylindre borgne.





NOTE

Guider le cylindre aveugle dans le trou avec un tournevis

Il est particulièrement difficile de positionner correctement le cylindre aveugle lorsque les portes sont épaisses.

1. Insérez un tournevis dans le trou du cylindre aveugle.
2. Positionnez le cylindre aveugle au moyen du tournevis.

















14. Insérez la béquille sur la ferrure extérieure.
 41
15. Vissez la vis sans tête de la béquille extérieure (TX15, couple : 5,0 Nm).
 42
16. Vissez le cylindre borgne (PH2, couple de serrage : 1,1 Nm).
 43

↳ Le montage de la ferrure est terminé.

11. Montage de la ferrure pour BKS

- ✓ Porte prépercée.
- ✓ Tournevis PH2 présent.
- ✓ Tournevis TX15 présent.
- ✓ Pied à coulisse présent.
- ✓ Scie disponible.

1. Mesurez l'épaisseur de la porte.
 26
2. Commandez la vis L1 dans la longueur appropriée auprès de BKS.
 45
3. Marquez les cadres de sciage sur les vis L2.
 46
4. Marquez les cadres de sciage sur les vis L2.
 47
5. Déterminez la longueur X en fonction du type de barre anti-panique.
 48
6. Marquez le cadre de sciage sur le carré.
 49
7. Raccourcissez les vis et le carré à l'aide d'une scie appropriée.
 50
8. Insérez l'écrou à manchon dans la plaque d'adaptation.
 30
9. Placez la plaque d'adaptation sur la ferrure électronique.
 31
10. Alignez les trous de la plaque d'adaptation avec les filetages de la ferrure.
 32
11. Vissez la plaque d'adaptation en croix (PH2, couple : 1,1 Nm).
 33





- Insérez le carré avec le côté broche dans la ferrure.
 34
- Insérez la ferrure avec la plaque d'adaptation, le carré et la base de la rosace dans la porte.
 56
- Vissez la ferrure au centre comme décrit dans la documentation BKS (utilisez la vis L1 et la vis à bois commandées auprès de BKS).
 57
- Vissez la base de la rosace sur le module avec les vis L2 (PH2, couple : 1,1 Nm).
 58
- Insérez le cylindre borgne.

**NOTE****Guider le cylindre aveugle dans le trou avec un tournevis**

Il est particulièrement difficile de positionner correctement le cylindre aveugle lorsque les portes sont épaisses.

- Insérez un tournevis dans le trou du cylindre aveugle.
- Positionnez le cylindre aveugle au moyen du tournevis.





- Enfichez le blinde de la rosace sur la base de la rosace.
 60
- Insérez la béquille sur la ferrure extérieure.
 61
- Vissez la vis sans tête de la béquille extérieure (TX15, couple : 5,0 Nm).
 62
- Vissez le cylindre borgne (PH2, couple de serrage : 1,1 Nm).
 63

↳ Le montage de la ferrure est terminé.

12. Démontage de la ferrure

✓ Clé à six pans 1,5 mm disponible.

- Démontez la ferrure dans l'ordre inverse du montage.
- Insérez une clé hexagonale de 1,5 mm dans le trou du carré conducteur de la ferrure.
 64
- Pliez la clé à six pans du côté où se trouve le trou et tirez simultanément sur la béquille extérieure.
 65

↳ La ferrure est démontée.

13. Remplacement des piles

**NOTE**











Dysfonctionnements dus à un mauvais contact ou à une décharge différentielle

Des surfaces de contact trop petites/contaminées ou différentes batteries déchargées peuvent entraîner des dysfonctionnements.

- Utilisez uniquement des piles autorisées par la société SimonsVoss.
- Ne touchez pas les contacts des piles neuves avec les mains.
- Utilisez des gants propres et exempts de graisse.
- Remplacez toujours toutes les piles à la fois.

✓ Outil spécial présent.

✓ Gants présents.

- Insérez l'outil spécial dans l'inlay du cache de protection de la ferrure.
 66
- Retirez le cache de protection à l'aide de l'outil.
 67
- Pliez délicatement le clip de la pile vers l'intérieur pour le décrocher.
 68
- Ouvrez le clip de la pile.
 69
- Retirez le clip de la pile.
 70
- Retirez le clip de la pile.
 71
- Retirez les piles usagées.
 72
- Mettez les piles neuves en place avec les pôles positifs en contact (type CR2450).
 73
- Remettez le clip de la pile en place.
 74
- Enclenchez le clip de la pile.
 75
- Remettez le cache de protection en place sur la ferrure.
 76
- Remettez en place le clip du cache de protection.
 77
- Remettez en place le clip du cache de protection.
 78

↳ Les piles sont remplacées.

14. Données techniques

Plage de température (fonctionnement)	de -25 °C à +50 °C
Types de piles	4 × CR2450 (3 V)
Fabricant de pile	<ul style="list-style-type: none"> ■ Murata ■ Varta ■ Panasonic
Classe de protection IP	IP40

Émissions de radio

15,24 kHz - 72,03 kHz Seulement pour les numéros d'article : SV-S2.*A*, SV-S2.*AM*, SV-S2.*LN*	10 dBµA/m (3 m distance)
13,560006 MHz - 13,560780 MHz	1,04 dBµA/m (3 m distance)
868,000 MHz - 868,600 MHz / 869,700 MHz - 870,000 MHz Seulement pour les numéros d'article : SV-S2.*LN*, SI-S2.*M.WO*	<25 mW ERP
2402 MHz - 2480 MHz	2,5 mW

15. Déclaration de conformité

La société SimonsVoss Technologies GmbH déclare par la présente que les articles (SV-S2.*A*, SV-S2.*AM*, SV-S2.*LN*, SI-S2.*M.WO*, SI-S2.*M.VCN*) est conforme aux directives suivantes:

- 2014/53/EU -RED-
ou pour UK : UK statutory 2017 No. 1206 -Radio equipment-
(équipement radio)
- 2011/65/UE -RoHS-
ou pour UK : UK statutory 2012 No. 3032 -RoHS-



Le texte intégral de la déclaration de conformité CE est disponible à l'adresse Internet suivante : www.simons-voss.com/fr/certificats.html.

Le texte intégral de la déclaration de conformité UK est disponible à l'adresse Internet suivante : www.simons-voss.com/fr/certificats.html.

16. Aide et autres informations

Documentation/documents

<https://www.simons-voss.com/fr/documents.html>

<https://www.smartintego.com/fr/home/infocenter/documentations>

Déclarations de conformité

<https://www.simons-voss.com/fr/certificats.html>

Informations sur l'élimination

- Ne jetez pas l'appareil (SV-S2.*A*, SV-S2.*AM*, SV-S2.*LN*, SI-S2.*M.WO*, SI-S2.*M.VCN*) avec vos ordures ménagères mais dans un point de collecte communal pour appareils électriques et appareils spéciaux conformément à la directive européenne 2012/19/UE.
- Recyclez les piles défectueuses ou usées conformément à la directive européenne 2006/66/CE.
- Veuillez tenir compte des dispositions locales applicables concernant la collecte séparée des piles.
- Recyclez l'emballage d'une manière écologique.



79

E-Mail

support-simonsvoss@allegion.com

si-support-simonsvoss@allegion.com

SimonsVoss Technologies GmbH, Feringastr. 4, D-85774 Unterfoehring, Allemagne

1. Beoogd gebruik

Bij de producten uit de SmartHandle AX-serie gaat het om elektronische deurbeslagen. Met behulp van een bevoegd identificatiemedium kan de SmartHandle AX activeren en de betreffende deur openen.

De bijbehorende rechten moeten met behulp van een elektronisch sluitplan worden toegewezen.

Producten uit de SmartHandle AX-serie mogen uitsluitend worden gebruikt voor het openen en sluiten van deuren. Een andersoortig gebruik is niet toegestaan.

2. Algemene veiligheidsinstructies

Signaalwoord: Mogelijke onmiddellijke gevolgen van niet-naleving

WAARSCHUWING: Dood of ernstig letsel (mogelijk, maar onwaarschijnlijk). **VOORZICHTIG:** Lichte letsel, LET OP: Materieel schade of storing, **OPMERKING:** Laag of nee



WAARSCHUWING

Geblokkeerde toegang

Door foutief geïnstalleerde en/of geprogrammeerde componenten kan de doorgang door een deur geblokkeerd blijven. Voor gevolgen van een geblokkeerde toegang tot gewonden of personen in gevaar, materiële of andere schade, is SimonsVoss Technologies GmbH niet aansprakelijk.

Geblokkeerde toegang als gevolg van manipulatie van het product

Als u het product zelf wijzigt, kunnen er storingen optreden en kan de toegang worden geblokkeerd door een deur.

- Vervang het product alleen wanneer dat nodig is en op de manier die in de documentatie wordt beschreven.

Batterijen niet inslikken. Verbrandingsgevaar door gevaarlijke stoffen

Dit product bevat lithium-knoopcellen. Als de knoopcel wordt ingeslikt, kunnen ernstige inwendige brandwonden optreden die binnen slechts twee uur de dood veroorzaken.

1. Houd nieuwe en gebruikte batterijen buiten bereik van kinderen.
2. Als het batterijvak niet goed sluit, mag u het product niet meer gebruiken en moet u het uit de buurt van kinderen houden.
3. Als u denkt dat batterijen zijn ingeslikt of in een ander lichaamsdeel terecht zijn gekomen, moet u onmiddellijk medische hulp inroepen.

Explosiegevaar door verkeerd type batterij

Het plaatsen van het verkeerde type batterij kan een explosie veroorzaken.

- Gebruik alleen de in de technische gegevens vermelde batterijen.



VOORZICHTIG

Brandgevaar door batterijen

De gebruikte batterijen kunnen bij verkeerde behandeling tot brand- of verbrandingsgevaar leiden.

1. Probeer niet de batterijen op te laden, open te maken, te verwarmen of te verbranden.
2. U mag de batterijen evenmin kortsluiten.

LET OP

Schade door elektrostatische ontlading (ESD) wanneer de behuizing open is

Dit product heeft elektronische componenten die kunnen worden beschadigd door een elektrostatische ontlading.

1. Maak gebruik van ESD-conforme materialen (bijv. aardingsarmband).
2. Zorg dat u geaard bent voor werkzaamheden waarbij u met de elektronica in contact kunt komen. Gebruik hiervoor geaarde metalen oppervlakken (bijv. Deurposten, waterleidingen of verwarmingsbuizen).

Beschadiging door vloeistoffen

Dit product heeft elektronische en/of mechanische componenten die kunnen worden beschadigd door elk type vloeistof.

- Houd vloeistoffen uit de buurt van de elektronica.

Beschadiging door bijtende reinigingsmiddelen

Het oppervlak van dit product kan worden beschadigd door ongeschikte reinigingsmiddelen.

- Maak uitsluitend gebruik van reinigingsmiddelen die geschikt zijn voor kunststof of metalen oppervlakken.

Beschadiging door mechanische impact

Dit product heeft elektronische componenten die kunnen worden beschadigd door elk type mechanische impact.

1. Vermijd dat u de elektronica aanraakt.
2. Vermijd ook andere mechanische impact op de elektronica.

Beschadiging door verwisseling van de polariteit

Dit product bevat elektronische componenten die door verwisseling van de polariteit van de voedingsbron beschadigd kunnen worden.

- Verwissel de polariteit van de voedingsbron niet (batterijen of netadapters).

Storing van het gebruik door verbroken verbinding

Dit product kan onder bepaalde omstandigheden beïnvloed worden door elektromagnetische of magnetische storingen.

- Monteer of plaats het product niet direct in de buurt van apparaten die elektromagnetische of magnetische storingen kunnen veroorzaken (stroomschakelaars).

Storing van de communicatie door metalen oppervlakken

Dit product communiceert draadloos. Metalen oppervlakken kunnen het zendbereik van het product aanzienlijk verminderen.

- Monteer of plaats het product niet op of in de buurt van metalen oppervlakken.



OPMERKING

Beoogd gebruik

SimonsVoss-producten zijn uitsluitend bedoeld voor het openen en sluiten van deuren en vergelijkbare voorwerpen.

- Gebruik SimonsVoss-producten niet voor andere doeleinden.

Storingen door slecht contact of verschillende ontladingen

Contactoppervlakken die te klein/vervuld zijn of verschillende ontladen accus kunnen leiden tot storingen.

1. Gebruik alleen batterijen die zijn vrijgegeven door SimonsVoss.
2. Raak de contacten van de nieuwe batterijen niet met de handen aan.
3. Gebruik schone, vetvrije handschoenen.
4. Vervang daarom alle batterijen tegelijk.

Afwijkende tijden bij G2-sluitelementen

De interne tijdeenheid van de G2-sluitelementen heeft een technisch bepaalde tolerantie van max. ± 15 minuten per jaar.

Kwaliteitsvereisten

De installatie en inbedrijfstelling vereist gespecialiseerde kennis. Alleen getraind personeel mag het product installeren en in bedrijf stellen.

Aanpassingen of nieuwe technische ontwikkelingen kunnen niet uitgesloten worden en worden gerealiseerd zonder aankondiging.

De Duitse taalversie is de originele handleiding. Andere talen (opstellen in de contracttaal) zijn vertalingen van de originele instructies.

Lees en volg alle installatie-, installatie- en inbedrijfstellingsinstructies. Geef deze instructies en eventuele onderhoudsinstructies door aan de gebruiker.

3. Specifieke veiligheidsinstructies per product

LET OP

Schade door boren

U boort op eigen risico. SimonsVoss Technologies GmbH is niet aansprakelijk voor schade veroorzaakt door het boren.

- Neem ook de veiligheidsinstructies van de boormachine in acht.

Schade veroorzaakt door ongeschikt gereedschap

Als u de koffer probeert te openen met ongeschikt gereedschap, kan de koffer beschadigd raken.

- Gebruik uitsluitend de meegeleverde SimonsVoss-openingsstool.

Verlies van precisie bij het bedienen van de deurkruk

De montage kan bij insteeksloten met klem een beetje moeilijk zijn.

- Bewerk de klem niet mechanisch. Anders functioneert de deurkruk niet meer precies.

Moelijke montage door onnauwkeurige boringen

Het beslag is niet monteerbaar wanneer de bevestigingsgaten en het vierkant niet bij elkaar passen.

- Zorg ervoor dat de lijnen van de bevestigingsgaten en het vierkant verticaal parallel zijn.

**OPMERKING****Afsluiting van de rozetopening**

Een evt. aanwezige rozetopening kan voor manipulaties worden gebruikt.

1. Sluit evt. aanwezige rozetopeningen af, bijvoorbeeld met een blinde cilinder.
2. Bij FH-varianten: monteer beslist een blind- of profielcilinder van messing.

Effect op de inkepingsslot

De SmartHandle AX werkt uitsluitend op de vergrendeling van het pennenslot.

Vergrendeling onder het verzekeringsrecht

Verzekeringsmaatschappijen stellen hogere eisen aan een sluiting.

1. Als u de deur op grond van de verzekeringswetgeving wilt vergrendelen, gebruik dan naast de SmartHandle AX een zelfremmend paniekslot of een sluitcilinder.
2. Let op de toelatingen volgens EN 179.

SmartHandle AX met zelfblokkerende paniekslot

De SmartHandle AX biedt alleen volledige functionaliteit met een zelfremmend paniekslot.

1. Combineer de SmartHandle AX met een zelfremmend paniekslot.
2. Let op de conformiteitsverklaringen van de slotfabrikanten volgens EN 179.

Vooraarden voor machtigingszekerheid

Gebruik met Mifare Classic en/of PinCode keypad sluit autorisatie veiligheidsklasse D volgens DIN EN 16867:2020 uit.

Documentatie van de fabrikant van de paniekslang

Neem ook de documentatie van de fabrikant van de paniekslang in acht (www.cisa.com of www.g-u.com).

Voorgebogen adapterplaat

De adapterplaat voor het beslag is voorgebogen. De voorspanning waarborgt na de montage de krachtsluiting naar de deur.

Reserveschroef inbegrepen

Bij de levering is een reserveschroef inbegrepen.

- Gebruik deze reserveschroef als u een schroef voor de montage van de adapterplaat hebt verloren.

4. Leveromvang

- SmartHandle AX (paniekslangversie voor CISA of BKS)
- Speciaal gereedschap
- Korte handleiding
- Blindcilinder

5. Opbouw CISA



6. Opbouw BKS



7. Deur voor CISA voorbereiden (boorsjabloon)

- ✓ Pen of kraspen beschikbaar.
- ✓ een boormachine beschikbaar houden.
- ✓ Geschikte boren aanwezig (Ø6,5 mm en 8,0 mm).
- ✓ PH2-schroevendraaier beschikbaar.
- ✓ Verzinkbaar beschikbaar.

1. Steek het vierkant in het insteekslot.



2. Plaats de boormal op het vierkant.



3. Lijn de boormal verticaal uit met behulp van de opgedrukte schaalverdeling.

4. Markeer de punten die geboord moeten worden op de deur.



5. Verwijder de boorsjabloon.



6. Verwijder het vierkant.



7. Demonteer het insteekslot (PH2).



8. Boor de benodigde gaten.



9. Verzink het onderste gat met een verzinkbaar.



10. Bouw het insteekslot in (PH2).



8. Deur voor BKS voorbereiden (boorsjabloon)

- ✓ Pen of kraspen beschikbaar.
- ✓ PH2-schroevendraaier beschikbaar.
- ✓ Liniaal aanwezig.
- ✓ een boormachine beschikbaar houden.
- ✓ Geschikte boren aanwezig (Ø6,5 mm en 8,0 mm).

1. Demonteer het insteekslot (PH2).



2. Meet de verticale afstand tussen de middelpunten van de bevestigingsgaten.



3. Bouw het insteekslot in (PH2).



4. Steek het vierkant in het insteekslot.



5. Plaats de boormal op het vierkant.



6. Lijn de boormal verticaal uit met behulp van de opgedrukte schaalverdeling.





7. Bepaal de te boren punten met behulp van de eerder gemeten afstand.

8. Markeer de punten die geboord moeten worden op de deur.



9. Verwijder de boorsjabloon.



10. Verwijder het vierkant.
 19
11. Demonteer het insteekslot (PH2).
 20
12. Boor de benodigde gaten.
 21
13. Bouw het insteekslot in (PH2).
 22



9. Beslag programmeren

Programmeer het beslag voor de montage. Afhankelijk van de productfamilie kunt u verschillende programmeerapparaten gebruiken.



10. Beslag voor CISA monteren

- ✓ Deur voorgeboord.
- ✓ PH2-schroevendraaier beschikbaar.
- ✓ TX15-schroevendraaier beschikbaar.
- ✓ Schuifmaat aanwezig.
- ✓ Saw beschikbaar.

1. Meet de deurdikte.
 26
2. Markeer de punten waar gezaagd moet worden op de schroeven en op het vierkant.
 27
 28
3. Kort de schroeven en het vierkant af met een geschikte zaag.
 29
4. Breng de hulsmoeren aan in de adapterplaat.
 30
5. Leg de adapterplaat op het elektronische beslag.
 31
6. Lijn de gaten in de adapterplaat uit met de schroefdraad in het beslag.
7. Schroef de adapterplaat kruiselings vast (PH2, draaimoment 1,1 Nm).
 32
 33
8. Steek het vierkant met de zijde met de pin in het beslag.
 34
9. Steek het beslag met adapterplaat en vierkant in de deur.
 35
10. Schroef het beslag in het midden vast (PH2, draaimoment 1,1 Nm).
 36
11. Schroef de adapterplaat ook onder het sleutelgat vast (PH2, draaimoment: 1,1 Nm).
 37
12. Schroef de houtschroef vast zoals beschreven in de CISA-documentatie.
 38
13. breng de blinde cilinder aan.





OPMERKING

Blinde cilinder met schroevendraaier in het gat leiden

In het bijzonder bij dikke deuren is het moeilijk om de blinde cilinder correct te positioneren.

1. Steek een schroevendraaier in het gat van de blinde cilinder.
2. Positioneer de blinde cilinder met behulp van de schroevendraaier.

















14. De deurkruk op het buitenbeslag steken.
 41
15. Schroef de stifttap van de buitenklink vast (TX15, draaimoment: 5,0 Nm).
 42
16. Schroef de blinde cilinder vast (PH2, draaimoment: 1,1 Nm).
 43

↳ Beslag is gereed gemonteerd.

11. Beslag voor BKS monteren

- ✓ Deur voorgeboord.
- ✓ PH2-schroevendraaier beschikbaar.
- ✓ TX15-schroevendraaier beschikbaar.
- ✓ Schuifmaat aanwezig.
- ✓ Saw beschikbaar.

1. Meet de deurdikte.
 26
2. Bestel de L1-schroef in de juiste lengte bij BKS.
 45
 46
3. Markeer de zaagsneden op de L2-schroeven.
 47
4. Bepaal afhankelijk van het type paniekstang de lengte X.
 48
5. markeer de zaagsnede op de vierkantstift.
 49
6. Kort de schroeven en het vierkant af met een geschikte zaag.
 50
7. Breng de hulsmoeren aan in de adapterplaat.
 30
8. Leg de adapterplaat op het elektronische beslag.
 31
9. Lijn de gaten in de adapterplaat uit met de schroefdraad in het beslag.
10. Schroef de adapterplaat kruiselings vast (PH2, draaimoment 1,1 Nm).
 32
 33
11. Steek het vierkant met de zijde met de pin in het beslag.
 34
12. Steek het beslag met adapterplaat, vierkant en rozetbasis in de deur.
 56
13. Schroef het beslag in het midden vast zoals beschreven in de BKS-documentatie (gebruik de L1-schroef en de houtschroef die bij BKS zijn besteld).
 57

- Schroef de rozetbasis vast op de componentengroep met de L2-schroeven (PH2, aanhaalmoment: 1,1 Nm).

- breng de blinde cilinder aan.

**OPMERKING****Blinde cilinder met schroevendraaier in het gat leiden**

In het bijzonder bij dikke deuren is het moeilijk om de blinde cilinder correct te positioneren.

- Steek een schroevendraaier in het gat van de blinde cilinder.
- Positioneer de blinde cilinder met behulp van de schroevendraaier.



- Steek de rozetafdekking op de basis van de rozet.



- De deurkruk op het buitenbeslag steken.



- Schroef de stifttap van de buitenklink vast (TX15, draaimoment: 5,0 Nm).



- Schroef de blinde cilinder vast (PH2, draaimoment: 1,1 Nm).



- ↳ Beslag is gereed gemonteerd.

12. Beslag demonteren

- ✓ 1,5 mm inbussleutel beschikbaar.

- Demonteer het beslag in omgekeerde volgorde van de montage.
- Steek een inbussleutel van 1,5 mm in het gat van de opname voor de vierkantstift in het beslag.



- Buig de inbussleutel naar de zijde waar het gat zich bevindt en trek tegelijkertijd aan de buitendeurkruk.



- ↳ Beslag is gedemonteerd.

13. Batterijen vervangen

**OPMERKING****Storingen door slecht contact of verschillende ontladingen**

Contactoppervlakken die te klein/vervuld zijn of verschillende ontladen accu's kunnen leiden tot storingen.

- Gebruik alleen batterijen die zijn vrijgegeven door SimonsVoss.
- Raak de contacten van de nieuwe batterijen niet met de handen aan.
- Gebruik schone, vetvrije handschoenen.
- Vervang daarom alle batterijen tegelijk.

- ✓ Speciaal gereedschap beschikbaar.
- ✓ Handschoenen aanwezig.

- Steek het speciale gereedschap in de cover-inlay van het beslag.



- Verwijder de cover met het gereedschap.



- Buig de batterijklem voorzichtig naar binnen om hem los te maken.



- Open de batterijklem.



- Trek de batterijklem eruit.



- Verwijder de oude batterijen.



- Zet de nieuwe batterijen in met de pluspolen tegen elkaar (type CR2450).



- Zet de batterijklem er weer in.



- Haak de batterijklem weer vast.



- Plaats de cover weer op het beslag.



- Klik de cover weer vast.



- ↳ De batterijen zijn vervangen.

14. Technische gegevens

Temperatuurbereik (bedrijf)	-25°C tot +50°C
Soort batterij	4 × CR2450 (3V)
Batterijmerk	<ul style="list-style-type: none"> ■ Murata ■ Varta ■ Panasonic
IP-beschermingsklasse	IP40

Radio-emissies

15,24 kHz - 72,03 kHz Alleen voor artikelnummers: SV-S2.*A*, SV-S2.*AM*, SV-S2.*LN*	10 dBµA/m (3 m afstand)
13,560006 MHz - 13,560780 MHz	1,04 dBµA/m (3 m afstand)
868,000 MHz - 868,600 MHz / 869,700 MHz - 870,000 MHz Alleen voor artikelnummers: SV-S2.*LN*, SI-S2.*M.WO*	<25 mW ERP
2402 MHz - 2480 MHz	2,5 mW

15. Verklaring van overeenstemming

Het bedrijf SimonsVoss Technologies GmbH verklaart dat de artikelen (SV-S2.*A*, SV-S2.*AM*, SV-S2.*LN*, SI-S2.*M.WO*, SI-S2.*M.VCN*) voldoen aan de volgende richtlijnen:

- 2014/53/EU -RED-
of voor de UK: UK wettelijk 2017 Nr. 1206 -Radioapparatuur-
- 2011/65/EU -RoHS-
of voor de UK: UK wettelijk 2012 Nr. 3032 -RoHS-



De volledige tekst van de EU-conformiteitsverklaring is beschikbaar op het volgende internetadres: www.simons-voss.com/nl/certificaten.html.
De volledige tekst van de UK-conformiteitsverklaring is beschikbaar op het volgende internetadres: www.simons-voss.com/nl/certificaten.html.

16. Hulp en verdere informatie

Informatiemateriaal/documenten

<https://www.simons-voss.com/nl/documenten.html>

<https://www.smartintego.com/int/home/infocenter/documentation>

Conformiteitsverklaringen

<https://www.simons-voss.com/nl/certificaten.html>

Informatie over verwijdering

- Voer het apparaat (SV-S2.*A*, SV-S2.*AM*, SV-S2.*LN*, SI-S2.*M.WO*, SI-S2.*M.VCN*) niet af als huishoudelijk afval, maar overeenkomstig de Europese Richtlijn 2012/19/EU bij een gemeentelijke inzamelpunt voor speciaal elektrotechnisch afval.
- Zorg voor recycling van defecte of gebruikte batterijen volgens de Europese Richtlijn 2006/66/EG.
- Neem de plaatselijke bepalingen in acht voor de gescheiden afvoer van batterijen.
- Voer de verpakking af naar een instantie voor milieuvriendelijke recycling.



E-mail

support-simonsvoss@allegion.com

si-support-simonsvoss@allegion.com

SimonsVoss Technologies GmbH, Feringastr. 4, 85774 Unterföhring, Duitsland

1. Uso conforme

I prodotti della serie SmartHandle AX sono maniglie elettroniche. Con l'ausilio di un mezzo di identificazione autorizzato SmartHandle AX può innestarsi e aprire la porta corrispondente.

Le relative autorizzazioni devono essere rilasciate con l'ausilio di un piano di chiusura elettronico.

I prodotti della serie SmartHandle AX possono essere utilizzati solo per l'apertura e la chiusura delle porte. Qualsiasi altro uso non è consentito.

2. Avvisi di sicurezza generali

Parola segnale: Possibili effetti immediati di non conformità

AVVERTENZA: Morte o lesioni gravi (possibili, ma improbabili), **ATTENZIONE:** Lesione minori, **AVVISO:** Danni materiali o malfunzionamento, **NOTA:** Basso o no



AVVERTENZA

Accesso bloccato

Con componenti montati e/o programmati in modo difettoso, l'accesso attraverso una porta può restare bloccato. La SimonsVoss Technologies GmbH non risponde delle conseguenze di un accesso bloccato, per esempio nel caso si debba accedere a persone ferite o in pericolo, di danni a cose o altri danni!

Accesso bloccato tramite manipolazione del prodotto

Se si modifica il prodotto da solo, possono verificarsi malfunzionamenti e l'accesso attraverso una porta può essere bloccato.

- Modificare il prodotto solo quando necessario e solo nel modo descritto nella documentazione.

Non ingerire la batteria. Pericolo di ustioni dovute a sostanze pericolose

Questo prodotto contiene batterie a bottone al litio. Se la batteria a bottone viene inghiottita, possono verificarsi gravi ustioni interne nel giro di sole due ore che possono causare la morte.

1. Conservare le batterie nuove e usate lontano dalla portata dei bambini.
2. Se il vano batteria non si chiude in modo sicuro, interrompere l'uso del prodotto e tenerlo lontano dalla portata dei bambini.
3. Se pensate che le batterie siano state inghiottite o si trovino in una qualsiasi parte del vostro corpo, rivolgetevi immediatamente a un medico.

Pericolo di esplosione a causa di un tipo di batteria non corretto

L'inserimento del tipo di batteria sbagliato può causare un'esplosione.

- Utilizzare solo le batterie specificate nei dati tecnici.



ATTENZIONE

Pericolo di incendio dovuto alle batterie

Le batterie utilizzate possono costituire un pericolo di incendio o combustione in caso di utilizzo scorretto.

1. Non tentare di caricare, aprire, riscaldare o bruciare le batterie.
2. Non cortocircuitare le batterie.

AVVISO

Danni dovuti a scariche elettrostatiche (ESD) quando l'alloggiamento è aperto

Il presente prodotto contiene componenti elettronici che potrebbero subire danni in conseguenza di scariche elettrostatiche.

1. Utilizzare materiali di lavori conformi ai requisiti ESD (ad es. fascetta antistatica al polso).
2. Effettuare la messa a terra dell'operatore prima di eseguire lavori in cui è possibile entrare in contatto con parti elettroniche. A tale scopo, toccare una superficie metallica opportunamente messa a terra (ad es. telaio porta, tubi dell'acqua o valvole di riscaldamento).

Danni dovuti a fluidi

Il presente prodotto contiene componenti elettronici e/o meccanici che potrebbero subire danni dovuti a liquidi di qualunque tipo.

- Tenere i componenti elettronici lontani da liquidi.

Danni dovuti a detergenti aggressivi

La superficie di questo prodotto può essere danneggiata da detergenti non idonei.

- Utilizzare esclusivamente detergenti adatti a superfici in plastica o metallo.

Danni dovuti a effetti meccanici

Il presente prodotto contiene componenti elettronici che potrebbero subire danni dovuti a effetti meccanici di qualunque tipo.

1. Evitare di toccare le parti elettroniche.
2. Evitare ulteriori effetti meccanici sulle parti elettroniche.

Danni dovuti all'inversione di polarità

Questo prodotto contiene componenti elettronici che possono essere danneggiati dall'inversione di polarità della sorgente di tensione.

- Non invertire la polarità della sorgente di tensione (batterie o alimentatori).

Funzionamento disturbato a causa di interferenze radioelettriche

Questo prodotto potrebbe essere influenzato da disturbi elettromagnetici o magnetici.

- Non montare o posizionare il prodotto direttamente accanto a dispositivi che possono causare interferenze elettromagnetiche o magnetiche (alimentatori switching!).

Interferenze nella comunicazione dovute a superfici metalliche

Questo prodotto comunica in modalità wireless. Le superfici metalliche possono ridurre significativamente la portata del prodotto.

- Non montare o posizionare il prodotto sopra o vicino a superfici metalliche.



NOTA

Uso conforme

I prodotti SimonsVoss sono concepiti esclusivamente per l'apertura e la chiusura di porte e oggetti simili.

- Non utilizzare i prodotti SimonsVoss per altri scopi.

Malfunzionamenti dovuti a contatto insufficiente o a scarichi diversi

Superfici di contatto troppo piccole/contaminate o diverse batterie scariche possono portare a malfunzionamenti.

1. Utilizzare esclusivamente batterie autorizzate da SimonsVoss.
2. Non toccare con le mani i contatti delle nuove batterie.
3. Utilizzare guanti puliti e privi di grasso.
4. Sostituire sempre tutte le batterie contemporaneamente.

Tempi diversi per chiusure G2

L'unità temporale interna delle chiusure G2 è tecnicamente vincolata a una tolleranza fino a ± 15 minuti all'anno.

Qualifiche richieste

L'installazione e la messa in servizio richiedono conoscenze specialistiche.

- Solo personale qualificato può installare e mettere in servizio il prodotto.

Non si escludono modifiche o perfezionamenti tecnici, anche senza preavvisi.

La versione in lingua tedesca è il manuale di istruzioni originale. Altre lingue (redazione nella lingua del contratto) sono traduzioni delle istruzioni originali.

Leggere e seguire tutte le istruzioni di installazione, installazione e messa in servizio. Passare queste istruzioni e tutte le istruzioni di manutenzione all'utente.

3. Avvertenze di sicurezza specifiche del prodotto

AVVISO

Danni da perforazione

Esercitate a vostro rischio e pericolo. SimonsVoss Technologies GmbH non è responsabile dei danni causati dalla perforazione.

- Osservare anche le norme di sicurezza del trapano.

Danni causati da utensili non idonei

Se si tenta di aprire la custodia con strumenti inadeguati, la custodia può essere danneggiata.

- Utilizzare solo l'utensile di apertura SimonsVoss in dotazione.

La maniglia non ha più una guida precisa

In caso di serrature ad incasso dotate di perno di riscontro, il montaggio della SmartHandle può risultare leggermente difficoltoso.

- Non modificare meccanicamente il perno di riscontro, poiché altrimenti la maniglia non avrà più una guida precisa.

Montaggio difficoltoso a causa di fori imprecisi

La maniglia non si può montare, quando i fori di fissaggio e il quadro maniglia non combaciano.

- Assicurarsi che le linee dei fori di fissaggio e del quadro maniglia risultino parallele in senso verticale.



NOTA

Chiusura dell'apertura delle rosette

Per le manipolazioni è possibile utilizzare l'apertura delle rosette ev. presenti.

1. Chiudere le aperture delle rosette ev. presenti, ad esempio con un cilindro cieco.
2. Per le varianti FH: installare obbligatoriamente un cilindro cieco o di chiusura in ottone.

Effetto sulla serratura da infilare

SmartHandle AX agisce esclusivamente sullo scrocco della serratura da infilare.

Blocco secondo la legge sulle assicurazioni

Le compagnie di assicurazione pongono maggiori richieste di chiusura.

1. Se si desidera chiudere la porta secondo la legge sull'assicurazione, oltre alla SmartHandle AX si può utilizzare una serratura antipanico autobloccante o un cilindro di chiusura.
2. Prestare attenzione alle omologazioni secondo EN 179.

SmartHandle AX con serratura antipanico autobloccante

SmartHandle AX offre tutte le funzionalità solo con una serratura antipanico autobloccante.

1. Combinare l'SmartHandle AX con una serratura antipanico autobloccante.
2. Prestare attenzione alle dichiarazioni di conformità dei produttori di serrature secondo EN 179.

Condizioni per la sicurezza dell'autorizzazione

Il funzionamento con la tastiera Mifare Classic e/o PinCode esclude la classe di sicurezza di autorizzazione D secondo la norma DIN EN 16867:2020.

Documentazione del produttore dei maniglioni antipanico

Osservare anche la documentazione del produttore dei maniglioni antipanico (www.cisa.com o www.g-u.com).

Piastra adattatrice già piegata

La piastra adattatrice per la maniglia è già piegata. Il precarico assicura l'aderenza alla porta dopo il montaggio.

Vite di riserva inclusa

Nella fornitura è inclusa una vite di riserva.

- È possibile utilizzare la vite di riserva nel caso in cui sia andata persa una vite per il montaggio della piastra adattatrice.

4. Oggetto di fornitura

- SmartHandle AX (maniglioni antipanico –versione per CISA o BKS)
- Attrezzo speciale
- Libretto di istruzioni
- Cilindro cieco

5. Struttura CISA



6. Struttura BKS



7. Preparazione della porta per CISA (maschera di foratura)

- ✓ Perno o punta per tracciare a disposizione.
- ✓ Trapano a disposizione.
- ✓ Punta adatta a disposizione (Ø 6,5 mm e 8,0 mm).
- ✓ Cacciavite PH2 a disposizione.
- ✓ Svasatore conico a disposizione.

1. Inserire il quadro maniglia nella serratura a incasso.



2. Applicare la maschera di foratura sul quadro maniglia.



3. Allineare la maschera di foratura in verticale con l'aiuto della scala graduata.

4. Segnare i punti da forare sulla porta.



5. Rimuovere la maschera di foratura.



6. Rimuovere il quadro maniglia.



7. Rimuovere la serratura a incasso (PH2).



8. Praticare i fori necessari.



9. Allargare il foro più in basso con uno svasatore conico.



10. Inserire la serratura a incasso (PH2).



8. Preparazione della porta per BKS (maschera di foratura)









- ✓ Perno o punta per tracciare a disposizione.
- ✓ Cacciavite PH2 a disposizione.
- ✓ Righello a disposizione.
- ✓ Trapano a disposizione.
- ✓ Punta adatta a disposizione (Ø 6,5 mm e 8,0 mm).

1. Rimuovere la serratura a incasso (PH2).



2. Misurare la distanza verticale tra i centri dei fori di fissaggio.



- Inserire la serratura a incasso (PH2).
 14
- Inserire il quadro maniglia nella serratura a incasso.
 3
- Applicare la maschera di foratura sul quadro maniglia.
 4
- Allineare la maschera di foratura in verticale con l'ausilio della scala graduata.
- Determinare i punti da forare con l'ausilio della distanza precedentemente misurata.
- Segnare i punti da forare sulla porta.
 17
- Rimuovere la maschera di foratura.
 6
- Rimuovere il quadro maniglia.
 19
- Rimuovere la serratura a incasso (PH2).
 20
- Praticare i fori necessari.
 21
- Inserire la serratura a incasso (PH2).
 22









9. Programmare la maniglia





Programmare la maniglia prima del montaggio. È possibile utilizzare diversi dispositivi di programmazione a seconda della famiglia di prodotti.



10. Montare la maniglia per CISA

- ✓ Porta già forata.
- ✓ Cacciavite PH2 a disposizione.
- ✓ Cacciavite TX15 a disposizione.
- ✓ Calibro a disposizione.
- ✓ Sega a disposizione.

- Misurare lo spessore della porta.
 26
- Contrassegnare i punti da segare sulle viti e sul quadro maniglia.
 27
 28
- Accorciare le viti e il quadro maniglia con una sega adatta.
 29
- Inserire i dadi a manicotto nella piastra adattatrice.
 30
- Posizionare la piastra adattatrice sulla maniglia elettronica.
 31
- Allineare i fori nella piastra adattatrice alla filettatura nella maniglia.
- Avvitare saldamente a croce la piastra adattatrice (PH2, coppia: 1,1 Nm).
 32
 33
- Applicare il quadro maniglia con il lato pin nella maniglia.
 34

- Inserire la maniglia con la piastra adattatrice e il quadro maniglia nella porta.
 35
- Avvitare saldamente la maniglia nel centro (PH2, coppia: 1,1 Nm).
 36
- Avvitare saldamente la piastra adattatrice anche al di sotto della toppa (PH2, coppia: 1,1 Nm).
 37
- Avvitare saldamente la vite per legno come descritto nella documentazione CISA.
 38
- Inserire il cilindro cieco.







NOTA

Posizionare il cilindro cieco nel foro utilizzando il cacciavite

Soprattutto per le porte di grande spessore, è difficile posizionare correttamente il cilindro cieco.









- Inserire un cacciavite nel foro del cilindro cieco.
- Posizionare il cilindro cieco con l'ausilio del cacciavite.







-  39
-  40
- Applicare la maniglia sulla maniglia esterna.
 41
- Avvitare saldamente la vite senza testa della maniglia esterna (TX15, coppia: 5,0 Nm).
 42
- Avvitare saldamente il cilindro cieco (PH2, coppia: 1,1 Nm).
 43

↳ La maniglia è completamente montata.

11. Montare la maniglia per BKS

- ✓ Porta già forata.
- ✓ Cacciavite PH2 a disposizione.
- ✓ Cacciavite TX15 a disposizione.
- ✓ Calibro a disposizione.
- ✓ Sega a disposizione.





- Misurare lo spessore della porta.
 26
- Ordinare le viti L1 nella lunghezza idonea a BKS.
 45
 46
- Contrassegnare i punti da segare sulle viti L2.
 47
- Determinare la lunghezza X in base al tipo di maniglia antipanic.
 48
- Contrassegnare il punto da segare sul quadro maniglia.
 49
- Accorciare le viti e il quadro maniglia con una sega adatta.
 50
- Inserire i dadi a manicotto nella piastra adattatrice.
 30
- Posizionare la piastra adattatrice sulla maniglia elettronica.
 31
- Allineare i fori nella piastra adattatrice alla filettatura nella maniglia.

10. Avvitare saldamente a croce la piastra adattatrice (PH2, coppia: 1,1 Nm).

11. Applicare il quadro maniglia con il lato pin nella maniglia.

12. Inserire la maniglia con la piastra adattatrice, il quadro maniglia e il portarosetta nella porta.

13. Avvitare saldamente la maniglia al centro come descritto nella documentazione BKS (utilizzare la vite L1 ordinata per BKS e la vite per legno).

14. Avvitare il portarosetta sul modulo con le viti L2 (PH2, coppia: 1,1 Nm).

15. Inserire il cilindro cieco.



**NOTA****Posizionare il cilindro cieco nel foro utilizzando il cacciavite**

Soprattutto per le porte di grande spessore, è difficile posizionare correttamente il cilindro cieco.

1. Inserire un cacciavite nel foro del cilindro cieco.
2. Posizionare il cilindro cieco con l'ausilio del cacciavite.

- 
 16. Applicare la rosetta sul portarosetta.

 17. Applicare la maniglia sulla maniglia esterna.

 18. Avvitare saldamente la vite senza testa della maniglia esterna (TX15, coppia: 5,0 Nm).

 19. Avvitare saldamente il cilindro cieco (PH2, coppia: 1,1 Nm).

- ↳ La maniglia è completamente montata.

12. Smontaggio della maniglia

- ✓ Chiave esagonale da 1,5 mm disponibile.
1. Smontare la maniglia procedendo nella sequenza opposta rispetto al montaggio.
 2. Inserire una chiave esagonale da 1,5 mm nel foro dell'alloggiamento del quadro maniglia nella maniglia.

 3. Girare la chiave esagonale dal lato sul quale si trova il foro e contemporaneamente tirare la maniglia esterna.

- ↳ La maniglia è smontata.















13. Sostituzione delle batterie

**NOTA****Malfunzionamenti dovuti a contatto insufficiente o a scarichi diversi**

Superfici di contatto troppo piccole/contaminate o diverse batterie scariche possono portare a malfunzionamenti.

1. Utilizzare esclusivamente batterie autorizzate da SimonsVoss.
2. Non toccare con le mani i contatti delle nuove batterie.
3. Utilizzare guanti puliti e privi di grasso.
4. Sostituire sempre tutte le batterie contemporaneamente.

- ✓ Attrezzo speciale a disposizione.
- ✓ Guanti a disposizione.

1. Inserire l'attrezzo speciale nell'inserto della cover della maniglia.

 2. Togliere la cover con l'attrezzo.

 3. Piegarlo con cautela il morsetto della batteria verso l'interno, per sgan-
ciarlo.

 4. Aprire il morsetto della batteria.

 5. Estrarre il morsetto della batteria.

 6. Rimuovere le vecchie batterie.
 7. Inserire le batterie nuove in modo tale che i poli positivi si tocchino (tipo
CR2450).

 8. Reinserrire la morsetto della batteria.

 9. Agganciare nuovamente il morsetto della batteria.

 10. Applicare nuovamente la cover sulla maniglia.

 11. Reintegrare saldamente la cover.

- ↳ Le batterie sono sostituite.

14. Dati tecnici

Range di temperature (esercizio)	da -25 °C a +50 °C
Tipo di batteria	4 × CR2450 (3V)
Marca delle batterie	<ul style="list-style-type: none"> ■ Murata ■ Varta ■ Panasonic
Grado di protezione	IP40

Emissioni radio

15,24 kHz - 72,03 kHz	10 dBµA/m (3 m distanza)
Solo per i codici articolo: SV-S2.*A*, SV-S2.*AM*, SV-S2.*LN*	
13,560006 MHz - 13,560780 MHz	1,04 dBµA/m (3 m distanza)

868,000 MHz - 868,600 MHz / 869,700 MHz - 870,000 MHz Solo per i codici articolo: SV- S2.*LN*, SI-S2.*M.WO*	<25 mW ERP
2402 MHz - 2480 MHz	2,5 mW

15. Dichiarazione di conformità

Het bedrijf SimonsVoss Technologies GmbH verklaart hierbij dat de artikelen (SV-S2.*A*, SV-S2.*AM*, SV-S2.*LN*, SI-S2.*M.WO*, SI-S2.*M.VCN*) voldoet aan de volgende richtlijnen:

- 2014/53/UE -RED-
o per il Regno Unito: Normativa del Regno Unito 2017 n. 1206
-Apparecchiature radio-
- 2011/65/UE -RoHS-
o per il Regno Unito: Normativa del Regno Unito 2012 n. 3032 -RoHS-



Il testo integrale della dichiarazione di conformità UE è disponibile al seguente indirizzo Internet: www.simons-voss.com/it/certificati.html.

Il testo integrale della dichiarazione di conformità UK è disponibile al seguente indirizzo Internet: www.simons-voss.com/it/certificati.html.

16. Supporto e ulteriori informazioni

Materiale informativo/Documents

<https://www.simons-voss.com/it/documenti.html>

<https://www.smartintego.com/int/home/infocenter/documentation>

Dichiarazioni di conformità

<https://www.simons-voss.com/it/certificati.html>

Informazioni sullo smaltimento

- Il dispositivo (SV-S2.*A*, SV-S2.*AM*, SV-S2.*LN*, SI-S2.*M.WO*, SI-S2.*M.VCN*) non va smaltito fra i rifiuti domestici, ma conferito presso un centro di raccolta comunale per rifiuti elettronici speciali in conformità con la Direttiva Europea 2012/19/UE.
- Riciclare le batterie guaste o esauste ai sensi della Direttiva Europea 2006/66/CE.
- Osservare le disposizioni locali in materia di smaltimento speciale delle batterie.
- Conferire l'imballaggio presso un punto di raccolta ai fini del riciclaggio ecologico.



E-mail

support-simonsvoss@allegion.com

si-support-simonsvoss@allegion.com

SimonsVoss Technologies GmbH, Feringastr. 4, D-85774 Unterfoehring, Germania

1. Anvendelsesområder

Ved SmartHandle AX-seriens produkter drejer det sig om elektroniske dørbeslag. SmartHandle AX kan koble ind og åbne den pågældende dør ved hjælp af et adgangsberegtiget identifikationsmedium.

Tilsvarende adgangstretigheder skal deles af en elektronik låseplan.

SmartHandle AX-seriens produkter må kun bruges til åbning og lukning af døre. Anden anvendelse er ikke tilladt.

2. Generelle sikkerhedshenvisninger

Signalord: Mulige direkte virkninger i tilfælde af manglende overholdelse

ADVARSEL: Død eller alvorlig personskade (muligt, men usandsynligt), FOR-

SIGTIG: Mindre skade, OPMÆRKSOMHED: Materiel skade eller fejlfunktion,

BEMÆRK: Lidt eller ingen



ADVARSEL

Spærret adgang

Hvis komponenter er fejlagtigt monteret og/eller programmeret, kan adgang til en dør forblive spærret. For følgeskader, der skyldes spærret adgang, fx til personer, der er sårede eller i fare, tingskader eller andre skader, hæfter SimonsVoss Technologies GmbH ikke!

Blokeret adgang gennem manipulation af produktet

Hvis du selv ændrer produktet, kan der opstå funktionsfejl, og adgang via en dør kan blokeres.

- Modificer kun produktet, når det er nødvendigt, og kun på den måde, der er beskrevet i dokumentationen.

Batteri må ikke indtages. Forbrændingsfare på grund af farlige stoffer

Dette produkt indeholder lithium-knappceller. Hvis knapcellen sluges, kan det medføre alvorlige indre forbrændinger inden for to timer og dødsfald.

1. Opbevar nye og brugte batterier uden for børns rækkevidde.
2. Hvis batterirummet ikke kan lukkes ordentligt, må produktet ikke længere benyttes, og det opbevares uden for børns rækkevidde.
3. Hvis du tror, at batterier er blevet slugt eller befinder sig i en legemsdel, skal du straks søge lægehjælp.

Eksplisionsfare på grund af forkert batteritype

Isætning af den forkerte batteritype kan resultere i en eksplosion.

- Brug kun de batterier, der er specificeret i de tekniske data.



FORSIGTIG

Brandfare ved batterier

Batterierne kan udgøre en brand- eller forbrændingsfare ved forkert behandling.

1. Forsøg ikke at oplade, åbne, opvarme eller brænde batterierne.
2. Kortslut ikke batterierne.

OPMÆRKSOMHED

Beskadigelse på grund af elektrostatisk afladning (ESD) med huset åbent

Dette produkt indeholder elektroniske komponenter, som kan blive beskadiget på grund af elektrostatisk afladning.

1. Brug ESD-beskyttede arbejdsmaterialer (f.eks. jordforbindelsesbånd).
2. Opret jordforbindelse før arbejde, hvor du kan komme i kontakt med elektronikken. Indfat i denne forbindelse jordforbundne metaloverflader (f.eks. dørarme, vandør eller varmeventiler).

Beskadigelse på grund af væske

Dette produkt indeholder elektroniske og/eller mekaniske komponenter, som kan blive beskadiget på grund af alle typer væsker.

- Hold væsker væk fra elektronikken.

Beskadigelse på grund af aggressive rengøringsmidler

Produktets overflade kan blive beskadiget på grund af uegnede rengøringsmidler.

- Brug kun rengøringsmidler, der er velegnede til kunststof- og metaloverflader.

Beskadigelse på grund af mekanisk påvirkning

Dette produkt indeholder elektroniske komponenter, som kan blive beskadiget på grund af alle typer mekanisk påvirkning.

1. Undgå at berøre elektronikken.
2. Undgå at udsætte elektronikken for andre mekaniske påvirkninger.

Beskadigelse på grund af fejltilslutning

Dette produkt indeholder elektroniske komponenter, som kan blive beskadiget på grund af fejltilslutning af spændingskilden.

- Sørg for ikke at fejltilslutte spændingskilden (batterier eller netdele).

Driftsforstyrrelse på grund af radiostøj

Dette produkt kan under visse omstændigheder påvirkes af elektromagnetiske eller magnetiske forstyrrelser.

- Monter eller anbring ikke produktet umiddelbart i nærheden af enheder, som kan medføre elektromagnetiske eller magnetiske forstyrrelser (strømforsyninger!).

Kommunikationsfejl på grund af metaloverflader

Dette produkt kommunikerer trådløst. Metaloverflader kan reducere produktets rækkevidde væsentligt.

- Monter eller anbring ikke produktet på eller i nærheden af metaloverflader.



BEMÆRK

Korrekt anvendelse

SimonsVoss-produkter er kun beregnet til åbning og lukning af døre og sammenlignelige genstande.

- Anvend ikke SimonsVoss-produkter til andre formål.

Funktionsfejl på grund af dårlig kontakt eller anden afladning

For små / forurenede kontaktområder eller forskellige afladede batterier kan føre til funktionsfejl.

1. Anvend kun batterier, som er frigivet af SimonsVoss.
2. Berør ikke de nye batteriers kontakter med hænderne.
3. Anvend rene og fedtfrie handsker.
4. Skift derfor altid alle batterier samtidigt.

Afvigende tidspunkter ved G2-lukninger

Den interne tidsenhed ved G2-lukninger har en teknisk betinget tolerance på op til ± 15 minutter om året.

Krævede kvalifikationer

Installation og driftsættelse kræver specialiseret viden.

- Kun uddannet personale må installere og driftsætte produktet.

Ændringer eller tekniske videreudviklinger kan ikke udelukkes og kan foretages uden forudgående varsel.

Den tyske sprogversion er den originale brugsanvisning. Andre sprog (udkast på kontraktssproget) er oversættelser af de originale instruktioner.

Læs og følg alle installations-, installations- og driftsættelsesinstruktioner. Overfør disse instruktioner og eventuel vedligeholdelsesinstruktion til brugeren.

3. Produktspecifikke sikkerhedsanvisninger

OPMÆRKSOMHED

Skade ved boring

De borer på at egen risiko. For skader forårsaget af boring er SimonsVoss Technologies GmbH ikke ansvarlig.

- Overhold også borens sikkerhedsinstruktioner.

Skader på grund af uegnet værktøj

Forsøg på at åbne sagen med et forkert værktøj kan beskadige sagen.

- Brug kun det medfølgende SimonsVoss åbningsværktøj.

Tab af præcis føring af håndtag

Montagen kan være stram ved indstikslåse med låsekasse.

- Låsekassen må ikke bearbejdes mekanisk. Håndtaget mister sin nøjagtige føring.

Vanskelig montering på grund af unøjagtige borehuller

Beslaget kan ikke monteres, hvis monteringshullerne og firkanten ikke passer sammen.

- Sørg for, at linjerne i monteringshullerne og firkanten er lodret parallelle.



BEMÆRK

Lukning af rosetåbning

En evt. eksisterende åbning i rosetten kan bruges til manipulationer.

- Luk evt. eksisterende åbninger i rosetten, f.eks. med en blindcylinder.
- Ved FH-varianten: Det er vigtigt at montere en blindcylinder eller låsecylinder af messing.

Effekt på indlåsningsslåsen

SmartHandle AX fungerer udelukkende på låsen på låseåbningen.

Lukningsforsikringslov

Forsikringselskaber stiller større krav til lukning.

- Hvis du vil lukke døren under forsikringsloven, skal du bruge en selv-låsende paniklås eller en låsecylinder ud over SmartHandle AX.
- Vær opmærksom på godkendelserne i henhold til EN 179.

SmartHandle AX med selv-låsende paniklås

SmartHandle AX tilbyder kun fuld funktionalitet med en selv-låsende paniklås.

- Kombiner SmartHandle AX med en selv-låsende paniklås.
- Vær opmærksom på låsefabrikantens overensstemmelseserklæringer i henhold til EN 179.

Betingelser for sikkerhedsstilling i forbindelse med tilladelsen

Drift med Mifare Classic- og/eller PinCode-tastatur udelukker autorisation sikkerhedsklasse D i henhold til DIN EN 16867:2020.

Dokumentation fra producenten af panikstangen

Følg også dokumentation fra producenten af panikstangen (www.cisa.com hvh. www.g-u.com).

Forbøjet adapterplade

Adapterpladen til beslaget er forbøjet. Forspændingen sikrer friktionsforbindelsen til døren efter montering.

Reserveskrue medfølger

En reserveskrue er inkluderet i leveringsomfanget.

- Brug denne reserveskrue, hvis du har mistet en skrue til montering af adapterpladen.

4. Leveringsomfang

- SmartHandle AX (panikstang-version til CISA eller BKS)
- Specialværktøj
- Kort vejledning

- Blindcylinder

5. Opstilling CISA



6. Opstilling BKS



7. Forbered døren til CISA (boreskabelon)

- Blyant eller ridsenål til stede.
- Boremaskine til rådighed.
- Passende bor til rådighed (Ø 6,5 mm og 8,0 mm).
- PH2-skruetrækker til rådighed.
- Konusforsænker tilgængelig.

- Sæt firkanten ind i indstikslåsen.



- Sæt boreskabelonen på firkanten.



- Juster boreskabelonen lodret ved hjælp af den påtrykte skala.

- Marker de punkter, der skal bores på døren.



- Fjern boreskabelonen.



- Fjern firkanten.



- Afmonter indstikslåsen (PH2).



- Bor de nødvendige huller.



- Forsænk det nederste hul med en konusforsænker.



- Monter indstikslåsen (PH2).



8. Forbered døren til BKS (boreskabelon)

- Blyant eller ridsenål til stede.
- PH2-skruetrækker til rådighed.
- Lineal til rådighed.
- Boremaskine til rådighed.
- Passende bor til rådighed (Ø 6,5 mm og 8,0 mm).

- Afmonter indstikslåsen (PH2).



- Mål den lodrette afstand mellem midten af fastgørelsehullerne.



- Monter indstikslåsen (PH2).



- Sæt firkanten ind i indstikslåsen.



- Sæt boreskabelonen på firkanten.







- Juster boreskabelonen lodret ved hjælp af den påtrykte skala.

- Bestem de punkter, der skal bores, ved hjælp af den tidligere målte afstand.

- Marker de punkter, der skal bores på døren.



9. Fjern boreskabelonen.
 6
10. Fjern firkanten.
 19
11. Afmonter indstikslåsen (PH2).
 20
12. Bor de nødvendige huller.
 21
13. Monter indstikslåsen (PH2).
 22













9. Programmering af beslag

Programér beslaget før montering. Afhængigt af produktfamilien kan du bruge forskellige programmeringsenheder.

- 
- 23
-
- 
- 24
-
- 
- 25

10. Montering af beslag til CISA

- ✓ Døren er forboret.
- ✓ PH2-skruetrækker til rådighed.
- ✓ TX15-skruetrækker til rådighed.
- ✓ Skydelære til rådighed.
- ✓ Sav er tilgængeligt.

1. Mål dørens tykkelse.
 26
2. Markér savepunkterne på skrueerne og på firkanten.
 27
 28
3. Afkort skrueerne og firkanten med en egnet sav.
 29
4. Sæt tyllermøtrikkerne i adapterpladen.
 30
5. Læg adapterpladen på det elektroniske beslag.
 31
6. Juster hullerne i adapterpladen med gevindene i beslaget.
7. Skru adapterpladen fast på tværs (PH2, drejningsmoment: 1,1 Nm).
 32
 33
8. Sæt firkanten med stiftsiden ind i beslaget.
 34
9. Sæt beslaget med adapterplade og firkant ind i døren.
 35
10. Skru beslaget fast i midten (PH2, drejningsmoment 1,1 Nm).
 36
11. Skru adapterpladen fast også under nøglehullet (PH2, drejningsmoment: 1,1 Nm).
 37
12. Skru træskruen fast som beskrevet i CISA-dokumentationen.
 38
13. Indsæt blindcylinderen.







BEMÆRK

Før blindcylinderen med skruetrækker i hullet















Især ved tykke døre er det svært at placere blindcylinderen korrekt.

1. Sæt en skruetrækker ind i hullet i blindcylinderen.
2. Placer blindcylinderen ved hjælp af skruetrækkeren.

- 
- 39
-
- 
- 40
-
14. Sæt håndtaget på det udvendige beslag.
 41
 15. Spænd gevindskruen på det udvendige håndtag (TX15, drejningsmoment: 5,0 Nm).
 42
 16. Skru blindcylinderen fast (PH2, drejningsmoment: 1,1 Nm).
 43
- ↳ Beslaget er færdigmonteret.

11. Montering af beslag til BKS

- ✓ Døren er forboret.
- ✓ PH2-skruetrækker til rådighed.
- ✓ TX15-skruetrækker til rådighed.
- ✓ Skydelære til rådighed.
- ✓ Sav er tilgængeligt.

1. Mål dørens tykkelse.
 26
2. Bestil L1-skruen i den passende længde hos BKS.
 45
 46
3. Markér savepunkterne på L2-skrueerne.
 47
4. Bestem længden X afhængigt af typen af panikstang.
 48
5. Markér savepunktet på firkanten.
 49
6. Afkort skrueerne og firkanten med en egnet sav.
 50
7. Sæt tyllermøtrikkerne i adapterpladen.
 30
8. Læg adapterpladen på det elektroniske beslag.
 31
9. Juster hullerne i adapterpladen med gevindene i beslaget.
10. Skru adapterpladen fast på tværs (PH2, drejningsmoment: 1,1 Nm).
 32
 33
11. Sæt firkanten med stiftsiden ind i beslaget.
 34
12. Sæt beslaget med adapterplade, firkant og rosetbase ind i døren.
 56
13. Skru beslaget fast i midten som beskrevet i BKS-dokumentationen (brug L1-skruen, som du har bestilt hos BKS, samt træskruen).
 57
14. Skru rosettens basisdel fast på modulet med L2-skrueerne (PH2, drejningsmoment: 1,1 Nm).
 58

15. Indsæt blindcylindren.

**BEMÆRK****Før blindcylindren med skruetrækker i hullet**

Især ved tykke døre er det svært at placere blindcylindren korrekt.

1. Sæt en skruetrækker ind i hullet i blindcylindren.
2. Placer blindcylindren ved hjælp af skruetrækkeren.



39

16. Sæt rosetdækslet på rosetbasen.



60

17. Sæt håndtaget på det udvendige beslag.



61

18. Spænd gevindskruen på det udvendige håndtag (TX15, drejningsmoment: 5,0 Nm).



62

19. Skru blindcylindren fast (PH2, drejningsmoment: 1,1 Nm).



63

- ↳ Beslaget er færdigmonteret.

12. Afmontering af beslag

- ✓ Anvend 1,5 mm unbrakonøgle.

1. Afmonter beslaget i omvendt rækkefølge i forhold til monteringen.
2. Sæt en 1,5 mm sekskantnøgle ind i hullet på den firkantede holder i beslaget.



64

3. Bøj sekskantnøglen til den side, hvor hullet er placeret, og træk samtidig i det udvendige håndtag.



65

- ↳ Beslaget er afmonteret.

13. Udskiftning af batterier

**BEMÆRK****Funktionsfejl på grund af dårlig kontakt eller anden afladning**

For små / forurenede kontaktområder eller forskellige afladede batterier kan føre til funktionsfejl.

1. Anvend kun batterier, som er frigivet af SimonsVoss.
2. Berør ikke de nye batteriers kontakter med hænderne.
3. Anvend rene og fedtfrie handsker.
4. Skift derfor altid alle batterier samtidigt.

- ✓ Specialværktøj er tilgængeligt.

- ✓ Handsker til rådighed.

1. Sæt specialværktøjet ind i dækslet på beslagsiden.



66

2. Tag dækslet af med værktøjet.



67



68

3. Bøj forsigtigt batteriklemmen indad for at hægte den af.



69



70

4. Åbn batteriklemmen.



71

5. Træk batteriklemmen ud.



72

6. Tag de gamle batterier ud.



73

7. Sæt de nye batterier i med de positive poler i berøring (type CR2450).



74

8. Sæt batteriklemmen på igen.



75

9. Sæt batteriklippen på plads igen.



76

10. Sæt dækslet tilbage på beslaget.



77

11. Klips dækslet fast igen.



78

- ↳ Batterierne er udskiftet.

14. Tekniske data

Temperaturområde (drift)	-25 °C til +50 °C
Batteritype	4 × CR2450 (3V)
Batteriproducent	<ul style="list-style-type: none"> ■ Murata ■ Varta ■ Panasonic
IP-kapslingsklasse	IP40

Radio emission

15,24 kHz - 72,03 kHz Kun for artikelnumre: SV-S2.*A*, SV-S2.*AM*, SV-S2.*LN*	10 dBµA/m (3 m afstand)
13,560006 MHz - 13,560780 MHz	1,04 dBµA/m (3 m afstand)
868,000 MHz - 868,600 MHz / 869,700 MHz - 870,000 MHz Kun for artikelnumre: SV-S2.*LN*, SI-S2.*M.WO*	<25 mW ERP
2402 MHz - 2480 MHz	2,5 mW

15. Overensstemmelseserklæring

Hermed erklærer SimonsVoss Technologies GmbH at varen (SV-S2.*A*, SV-S2.*AM*, SV-S2.*LN*, SI-S2.*M.WO*, SI-S2.*M.VCN*) overholder følgende retningslinjer:

- 2014/53/EU -RED- eller for Storbritannien: UK lovbekendtgørelse 2017 nr. 1206 -Radioudstyr-
- 2011/65/EU -RoHS- eller for Storbritannien: UK lovbekendtgørelse 2012 nr. 3032 -RoHS-



Den fulde ordlyd af EU-overensstemmelseserklæringen er tilgængelig på følgende internetadresse: www.simons-voss.com/dk/certifikater.html.
Den fulde ordlyd af UK-overensstemmelseserklæringen er tilgængelig på følgende internetadresse: www.simons-voss.com/dk/certifikater.html.

16. Hjælp og flere oplysninger

Infomateriale/dokumenter

<https://www.simons-voss.com/dk/dokumenter.html>

<https://www.smartintego.com/int/home/infocenter/documentation>

Overensstemmelseserklæringer

<https://www.simons-voss.com/dk/certifikater.html>

Oplysninger om bortskaffelse

- Enheden (SV-S2.*A*, SV-S2.*AM*, SV-S2.*LN*, SI-S2.*M.WO*, SI-S2.*M.VCN*) må ikke bortskaffes med husholdningsaffaldet, men skal afleveres på den kommunale affaldsplads, jf. det europæiske direktiv 2012/19/EU.
- Brugte eller defekte batterier skal genanvendes jf. det europæiske direktiv 2006/66/EG.
- Overhold de lokale bestemmelser for separat bortskaffelse af batterier.
- Aflever emballagen til miljørigtig genanvendelse.



e-mail

support-simonsvoss@allegion.com

si-support-simonsvoss@allegion.com

SimonsVoss Technologies GmbH, Feringastr. 4, D-85774 Unterföhring, Tyskland

1. Avsedd användning

Produkterna i SmartHandle AX-serien gäller elektroniska dörrhandtag. Med hjälp av ett behörigt identifikationsmedium kan man aktivera SmartHandle AX och öppna motsvarande dörr.

Behörigheter måste tilldelas med hjälp av ett elektroniskt låsschema.

Produkterna i SmartHandle AX-serien får bara användas för att öppna och stänga dörrar. Varje annan användning är förbjuden.

2. Allmänna säkerhetsanvisningar

Signalord: Eventuella omedelbara effekter av bristande efterlevnad

VARNING: Död eller allvarlig skada (möjligt, men osannolikt), **OBSERVERA:** Liten skada, **OBS:** Skador på egendom eller fel, **INFO:** Låg eller ingen



VARNING

Tillgång spärrad

Felaktigt installerade och/eller programmerade komponenter kan leda till att dörrar spärras. SimonsVoss Technologies GmbH ansvarar inte för konsekvenserna av felaktig installation såsom spärrat tillträde till skadade personer eller personer i risksituationer, materiella skador eller andra typer av skador.

Blockerad åtkomst genom manipulering av produkten

Om du ändrar produkten på egen hand kan fel uppstå och åtkomst via en dörr kan blockeras.

- Ändra endast produkten vid behov och endast på det sätt som beskrivs i dokumentationen.

Svälj inte batteriet. Risk för brännskador på grund av farliga ämnen.

Den här produkten innehåller litiumknappcells-batterier. Om man råkar svälja ett knappcells-batteri kan allvarliga inre brännskador uppstå inom bara två timmar vilket i sin tur kan leda till döden.

- Förvara nya och förbrukade batterier utom räckhåll för barn.
- Upphör att använda produkten och förvara den utom räckhåll för barn om batterilocket inte går att stänga ordentligt.
- Uppsök omedelbart läkare om du misstänker att batterier har svalts eller befinner sig i någon kroppsdel.

Explosionsrisk på grund av felaktigt batterityp

Att sätta i fel typ av batteri kan leda till en explosion.

- Använd endast de batterier som anges i de tekniska data.



OBSERVERA

Brandrisk som utgår från batterier

De isatta batterierna kan orsaka brand eller brännskador om de hanteras på ett felaktigt sätt.

- Försök inte att ladda upp, öppna eller värma upp batterierna.
- Kortslut inte batterierna.

OBS

Skador på grund av elektrostatiske urladdning (ESD) när hölet är öppet

Den här produkten innehåller elektroniska komponenter som kan skadas av elektrostatiske urladdningar.

- Använd alltid ESD-anpassat arbetsmaterial (t.ex. jordningsarmband).
- Jorda dig före alla arbeten där du kan komma i kontakt med elektronik. Det gör du genom att fatta tag i en jordad metallta (såsom dörrkarmar, vattenrör eller värmeventiler).

Skada på grund av vätskor

Den här produkten innehåller elektroniska och/eller mekaniska komponenter som kan skadas av alla typer av vätskor.

- Låt inte elektroniken komma i kontakt med vätskor.

Skada på grund av aggressiva rengöringsmedel

Ytan på den här produkten kan skadas om olämpliga rengöringsmedel används.

- Använd endast rengöringsmedel som lämpar sig för plast- och metalltytor.

Skada på grund av mekanisk påverkan

Den här produkten innehåller elektroniska komponenter som kan skadas av alla typer av mekanisk påverkan.

- Undvik att vidröra elektroniken.
- Undvik annan mekanisk påverkan på elektroniken.

Skada på grund av polvändning

Den här produkten innehåller elektroniska komponenter som kan skadas på grund av polvändning i spänningskällan.

- Vänd inte spänningskällans poler (batterier resp. nätdelar).

Driftstörning på grund av radiostörning

Den här produkten kan i vissa fall påverkas av elektromagnetiska eller magnetiska störningar.

- Produkten ska inte monteras eller placeras i omedelbar närhet av utrustning som kan orsaka elektromagnetiska eller magnetiska störningar (switchade nättaggregat!).

Kommunikationsstörning på grund av metalltytor

Den här produkten kommunicerar trådlöst. Metalltytor kan minska produktens räckvidd avsevärt.

- Produkten ska inte monteras eller placeras på eller i närheten av metalltytor.



INFO

Avsedd användning

SimonsVoss-produkter är uteslutande avsedda för öppning och stängning av dörrar och liknande.

- Använd inte SimonsVoss-produkter för andra syften.

Funktionsstörningar på grund av dålig dålig kontakt eller annan urladdning

För små / kontaminerade kontaktytor eller olika urladdade batterier kan leda till funktionsstörningar.

- Används endast batterier som är godkända av SimonsVoss.
- Vidrör inte de nya batteriernas kontakter med händerna.
- Använd rena och fettfria handskar.
- Byt alltid alla batterier samtidigt.

Avvikande tider vid G2-lås

G2-låsens interna tidsenhet har en tekniskt betingad tolerans på upp till ± 15 minuter per år.

Kvalifikationer krävs

Installation och idrifttagning kräver specialiserad kunskap.

- Endast utbildad personal får installera och driftsätta produkten.

Ändringar eller teknisk vidareutveckling kan inte uteslutas och kan komma att genomföras utan föregående meddelande om detta.

Den tyska språkversionen är den ursprungliga bruksanvisningen. Andra språk (utarbetade på kontraktsspråket) är översättningar av originalinstruktionerna.

Läs och följ alla installations-, installations- och driftsinstruktioner. Skicka dessa instruktioner och alla underhållsinstruktioner till användaren.

3. Produktspecifika säkerhetsanvisningar

OBS

Skada vid borring

De borrar på egen risk. För skador orsakade av borring är SimonsVoss Technologies GmbH inte ansvarigt. Sie bohren auf eigene Gefahr.

- Beakta också borrhens säkerhetsinstruktioner.

Skador på grund av olämpligt verktyg

Att försöka öppna ärendet med ett felaktigt verktyg kan skada fallet.

- Använd endast det medföljande SimonsVoss-öppningsverktyget.

Förlust av exakt handtagsstyrning

Hos instickslåås med klämhylsa kan monteringen vara trög.

- Bearbeta inte klämhylsan mekaniskt. Handtaget förlorar då sin exakta styrning.

Försvårad montering på grund av oprecisa håll

Handtaget kan inte monteras om monteringshålens och fyrkanten inte passar ihop.

- Kontrollera att monteringshålens och fyrkantens linjer är parallella vertikalt.

**INFO****Försluta rosettöppning**

En rosettöppning kan utnyttjas för manipulation.

1. Förslut eventuella rosettöppningar med exempelvis en blindcylinder.
2. För FH-varianter: Montera ovillkorligen en blind- eller låscylinder av mässing.

Påverkan på låsningen

SmartHandle AX fungerar uteslutande på spärrlåset.

Försäkringslagstiftning

Försäkringsbolag ställer större krav på stängning.

1. Om du vill stänga dörren enligt försäkringslagarna, använd ett självlåsande paniklås eller en låscylinder utöver SmartHandle AX.
2. Var uppmärksam på godkännandena enligt EN 179.

SmartHandle AX med självlåsande paniklås

SmartHandle AX erbjuder full funktionalitet endast med ett självlåsande paniklås.

1. Kombinera SmartHandle AX med ett självlåsande paniklås.
2. Var uppmärksam på förklaringarna om överensstämmelse hos låsetillverkaren enligt EN 179.

Villkor för säkerhet i samband med tillstånd

Drift med Mifare Classic- och/eller PinCode-tangentbord utesluter behörighetssäkerhetsklass D enligt DIN EN 16867:2020.

Dokumentation från panikregelns tillverkare

Beakta även dokumentationen från panikregelns tillverkare (www.cisa.com resp. www.g-u.com).

Böjd adapterplatta

Adapterplattan till beslaget är böjd. Spänningen säkerställer dörrens adhesion efter montering.

Reservskruv medföljer

I leveransomfånget medföljer en reservskruv.

- Du kan använda den här reservskruven om en skruv för montering av adapterplattan har förkommit.

4. Leveransomfång

- SmartHandle AX (Panikregelversion för CISA eller BKS)
- Specialverktyg
- Snabbguide
- Blindcylinder

5. Uppbyggnad CISA



6. Uppbyggnad BKS



7. Förbereda dörr för CISA (borschablon)

- ✓ Stift eller ritsnål finns.
- ✓ Borrmaskin finns.
- ✓ Lämplig borr finns (Ø6,5 mm och 8,0 mm).
- ✓ PH2-skruvmejsel finns.
- ✓ Konförsänkare finns.

1. Stick in fyrkanten i instickslåset.

2. Sätt på borschablonen på fyrkanten.

3. Rikta in borschablonen lodrätt med hjälp av den påtryckta skalan.
4. Markera borrpunkterna på dörren.

5. Avlägsna borschablonen.

6. Avlägsna fyrkanten.

7. Demontera instickslåset (PH2).











8. Borra de hål som behövs.

9. Försänk det nedersta hålet med en konförsänkare.

10. Montera instickslåset (PH2).

8. Förbereda dörr för BKS (borschablon)

- ✓ Stift eller ritsnål finns.
- ✓ PH2-skruvmejsel finns.
- ✓ Linjal finns.
- ✓ Borrmaskin finns.
- ✓ Lämplig borr finns (Ø6,5 mm och 8,0 mm).

1. Demontera instickslåset (PH2).

2. Mät det vertikala avståndet mellan fästhålens centrum.

3. Montera instickslåset (PH2).

4. Stick in fyrkanten i instickslåset.

5. Sätt på borschablonen på fyrkanten.

6. Rikta in borschablonen lodrätt med hjälp av den påtryckta skalan.
7. Fastställ borrpunkterna med hjälp av det nyss uppmätta avståndet.
8. Markera borrpunkterna på dörren.

9. Avlägsna borschablonen.

10. Avlägsna fyrkanten.

11. Demontera instickslåset (PH2).

12. Borra de hål som behövs.

13. Montera instickslåset (PH2).



22

9. Programmera handtag

Programmera handtaget före montering. Beroende på produktfamilj kan du använda olika programmeringsenheter.



23



24



25

10. Montera handtag för CISA

- ✓ Dörr förborrad.
- ✓ PH2-skruvmejsel finns.
- ✓ TX15-skruvmejsel finns.
- ✓ Skjutmått finns.
- ✓ Såg finns.

1. Mät dörrtjockleken.



26

2. Markera sågställena på skruvarna och fyrkanten.



27



28

3. Korta av skruvarna och fyrkanten med en lämplig såg.



29

4. Sätt i hylsmuttern i adapterplattan.



30

5. Placera adapterplattan på det elektroniska handtaget.



31

6. Rikta in adapterplattans hål och beslagets gänga.

7. Skruva fast adapterplattan korsvis (PH2, åtdragningsmoment: 1,1 Nm).



32



33

8. Stick in fyrkanten med stiftsidan i handtaget.



34

9. Sätt i handtaget med adapterplatta och fyrkant i dörren.



35

10. Skruva fast handtaget i mitten (PH2, åtdragningsmoment 1,1 Nm).



36

11. Skruva fast adapterplattan även under nyckelhålet (PH2, åtdragningsmoment: 1,1 Nm).



37

12. Skruva fast träskruven enligt beskrivning i CISA-dokumentationen.



38

13. Sätt i blindcylindern.



39



40

För in blindcylindern i hålet med skruvmejseln.

Särskilt om dörrarna är tjocka är det svårt att positionera blindcylindern korrekt.

1. Sätt in en skruvmejseln i hålet för blindcylindern.
2. Positionera blindcylindern med hjälp av skruvmejseln.



39



40

14. Sätt handtaget på ytterbeslaget.



41

15. Skruva fast ytterhandtagets stoppskruv (TX15, åtdragningsmoment: 5,0 Nm).



42

16. Skruva fast blindcylindern (PH2, åtdragningsmoment: 1,1 Nm).



43

- ↳ Handtaget är färdigmonterat.

11. Montera handtag för BKS

- ✓ Dörr förborrad.
- ✓ PH2-skruvmejsel finns.
- ✓ TX15-skruvmejsel finns.
- ✓ Skjutmått finns.
- ✓ Såg finns.

1. Mät dörrtjockleken.



26

2. Beställ L1-skraven i passande längd från BKS.



45



46

3. Markera sågställena på L2-skruvarna.



47

4. Bestäm längden X beroende på typ av panikregel.



48

5. Markera sågstället på fyrkanten.



49

6. Korta av skruvarna och fyrkanten med en lämplig såg.



50

7. Sätt i hylsmuttern i adapterplattan.



30

8. Placera adapterplattan på det elektroniska handtaget.



31

9. Rikta in adapterplattans hål och beslagets gänga.

10. Skruva fast adapterplattan korsvis (PH2, åtdragningsmoment: 1,1 Nm).



32



33

11. Stick in fyrkanten med stiftsidan i handtaget.



34

12. Sätt i handtaget med adapterplatta, fyrkant och rosettbas i dörren.



56

13. Skruva fast handtaget i mitten enligt beskrivning i BKS-dokumentationen (använd L1-skraven och träskruven som beställts från BKS).



57

14. Skruva fast rosettbasen på modulen med L2-skruvarna (PH2, åtdragningsmoment: 1,1 Nm).



58

15. Sätt in blindcylindern.



INFO



INFO





För in blindcylindern i hålet med skruvmejseln.

Särskilt om dörrarna är tjocka är det svårt att positionera blindcylindern korrekt.



1. Sätt in en skruvmejseln i hålet för blindcylindern.
2. Positionera blindcylindern med hjälp av skruvmejseln.



39

16. Sätt rosetbrickan på rosetbasen.
 60
 17. Sätt handtaget på ytterbeslaget.
 61
 18. Skruva fast ytterhandtagets stoppskruv (TX15, åtdragningsmoment: 5,0 Nm).
 62
 19. Skruva fast blindcylindern (PH2, åtdragningsmoment: 1,1 Nm).
 63
- ↳ Handtaget är färdigmonterat.

12. Demontera handtag

- ✓ 1,5 mm sexkantsnyckel finns.
1. Demontera handtaget i omvänd ordningsföljd jämfört med montering.
 2. Sätt i en 1,5 mm-insexnyckel i hålet på fyrkantsfästet i handtaget.
 64
 3. Böj insexnyckeln åt den sida där hålet sitter och dra samtidigt i ytterhandtaget.
 65
- ↳ Handtaget är demonterat.

13. Byt batterier.













INFO



Funktionsstörningar på grund av dålig dålig kontakt eller annan urladdning

För små / kontaminerade kontaktytor eller olika urladdade batterier kan leda till funktionsstörningar.

1. Används endast batterier som är godkända av SimonsVoss.
2. Vidrör inte de nya batteriernas kontakter med händerna.
3. Använd rena och fettfria handskar.
4. Byt alltid alla batterier samtidigt.

- ✓ Specialverktyg finns.
- ✓ Handskar finns.

1. Sätt i specialverktyget i kåpinlägget på handtaget.
 66
2. Avlägsna kåpan med verktyget.
 67
 68
3. Böj batteriklämman försiktigt inåt för att haka ur den.
 69
 70
4. Öppna batteriklämman.
 71
5. Dra ut batteriklämman.
 72
6. Ta ur de gamla batterierna.
 73
7. Sätt i de nya batterierna så att pluspolerna vidrör varandra (typ CR2450).
 74
8. Sätt tillbaka batteriklämman igen.
 75

9. Haka i batteriklämmorna igen.
 76
 10. Sätt tillbaka kåpan på handtaget.
 77
 11. Knäpp fast kåpan igen.
 78
- ↳ Batterierna är bytta.

14. Tekniska data

Temperaturområde (drift)	-25 °C till +50 °C
Batterityp	4 × CR2450 (3V)
Batteritillverkare	<ul style="list-style-type: none"> ■ Murata ■ Varta ■ Panasonic
IP-kapslingsklass	IP40

Utsläpp radio

15,24 kHz - 72,03 kHz Endast för artikelnummer: SV-S2.*A*, SV-S2.*AM*, SV-S2.*LN*	10 dBµA/m (3 m avstånd)
13,560006 MHz - 13,560780 MHz	1,04 dBµA/m (3 m avstånd)
868,000 MHz - 868,600 MHz / 869,700 MHz - 870,000 MHz Endast för artikelnummer: SV-S2.*LN*, SI-S2.*M.WO*	<25 mW ERP
2402 MHz - 2480 MHz	2,5 mW

15. Försäkran om överensstämmelse

Häriförklarar SimonsVoss Technologies GmbH att varan (SV-S2.*A*, SV-S2.*AM*, SV-S2.*LN*, SI-S2.*M.WO*, SI-S2.*M.VCN*) uppfyller följande riktlinjer:

- 2014/53/EU -RED- eller för Storbritannien: Förenade kungarikets lag 2017 nr 1206 -Radioutrustning-
- 2011/65/EU -RoHS- eller för Storbritannien: Förenade kungarikets lag 2012 nr 3032 -RoHS-



Den fullständiga texten till EU-försäkran om överensstämmelse finns på följande internetadress: www.simons-voss.com/se/certifikat.html.
Den fullständiga texten till UK-försäkran om överensstämmelse finns på följande internetadress: www.simons-voss.com/se/certifikat.html.

16. Hjälp och ytterligare information

Infomaterial/dokument

<https://www.simons-voss.com/se/dokument.html>
<https://www.smartintego.com/int/home/infocenter/documentation>

Försäkringar om överensstämmelse

<https://www.simons-voss.com/se/certifikat.html>

Informationen är öppen

- Produkten (SV-S2.*A*, SV-S2.*AM*, SV-S2.*LN*, SI-S2.*M.WO*, SI-S2.*M.VCN*) får inte slängas i hushållsoporna utan ska lämnas in på en kommunal uppsamlingsplats för elektriskt och elektroniskt avfall i enlighet med direktiv 2012/19/EU.
- Defekta eller uttjänta batterier ska återvinnas i enlighet med direktiv 2006/66/EG.
- Beakta gällande lokala bestämmelser gällande separat bortskaftande av batterier.
- Avfallshantera förpackningsmaterial på ett miljövänligt sätt.
 79

support-simonsvoss@allegion.com

si-support-simonsvoss@allegion.com

SimonsVoss Technologies GmbH, Feringastr. 4, D-85774 Unterföhring,
Tyskland

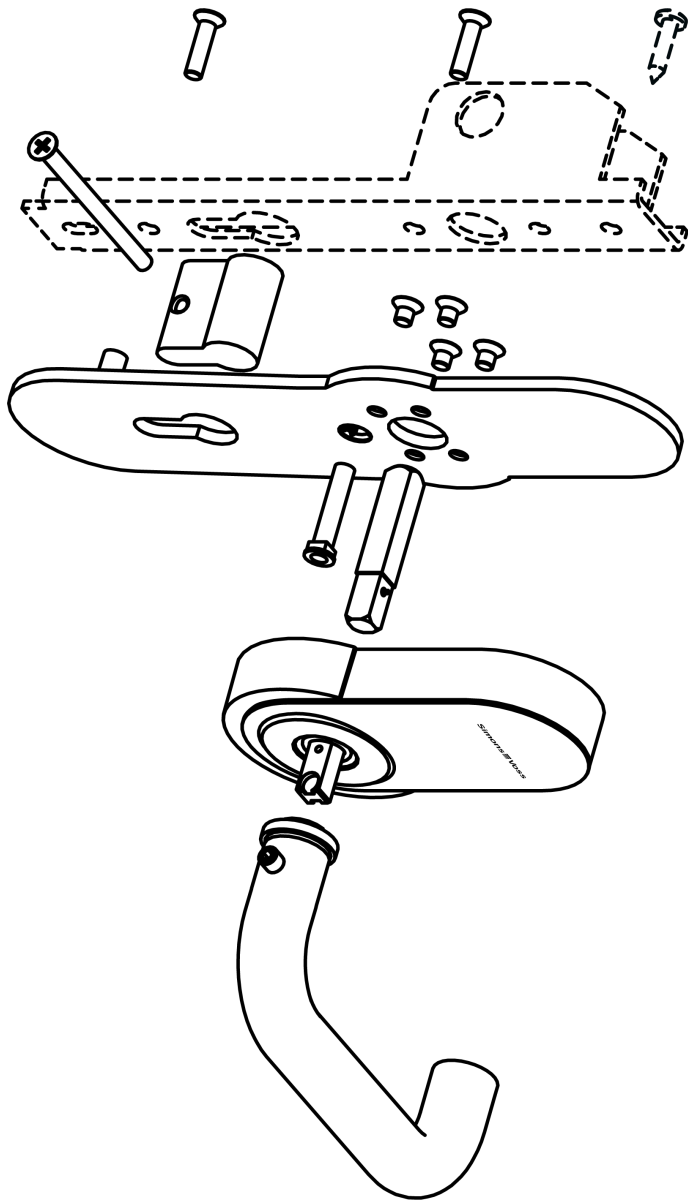

© 2024, SimonsVoss Technologies GmbH, Unterföhring

All rights are reserved. Text, images and diagrams are protected under copyright law.

The content of this document must not be copied, distributed or modified. You can find more information on our website. Subject to technical changes.

SimonsVoss and MobileKey are registered brands belonging to SimonsVoss.

SimonsVoss
technologies

Made in Germany

A BRAND OF

