



Locking cylinder (Z4) Euro Profile CO, FD

Z54.0.990535  
23.04.2024

DE Kurzanleitung  
EN Quick guide  
FR Guide abrégé  
NL Korte handleiding  
IT Guida breve  
DK Kort vejledning  
SE Snabbguide



Abb./img. 5



Abb./img. 6

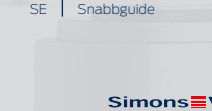

Abb./img. 7



Abb./img. 1

### 3. Variants

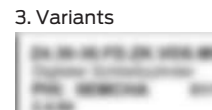

Abb./img. 2

### 5. Installation



Abb./img. 3



Abb./img. 4



Abb./img. 7

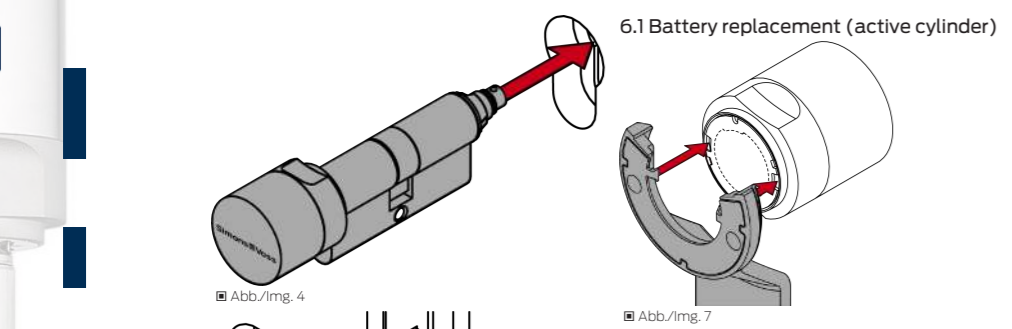

Abb./img. 11

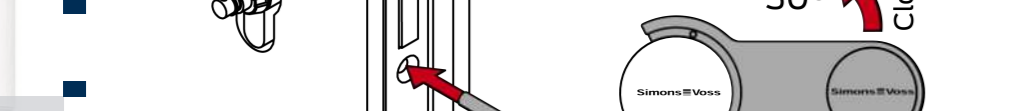

Abb./img. 12



Abb./img. 13



Abb./img. 15

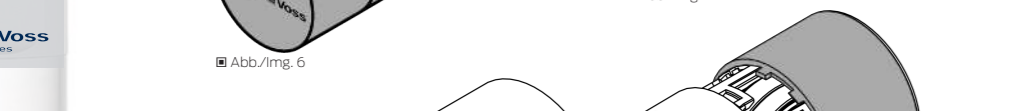

Abb./img. 16



Abb./img. 18



Abb./img. 19



Abb./img. 15



Abb./img. 16



Abb./img. 16



Abb./img. 17



Abb./img. 18

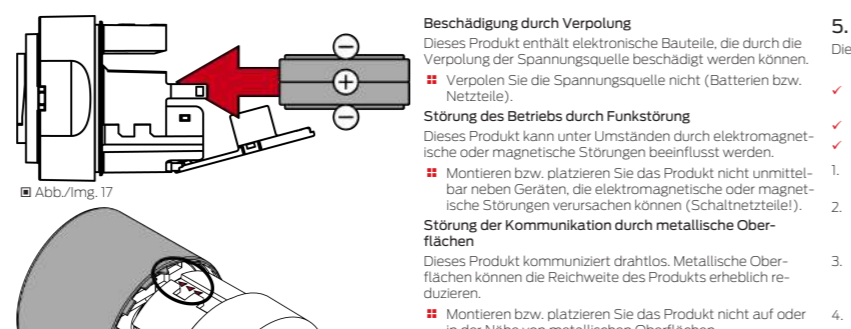

Abb./img. 19

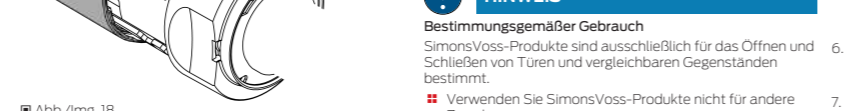

Abb./img. 19

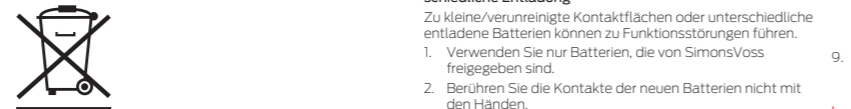

Abb./img. 19

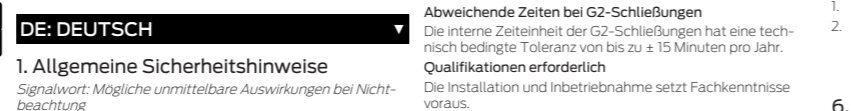

Abb./img. 19

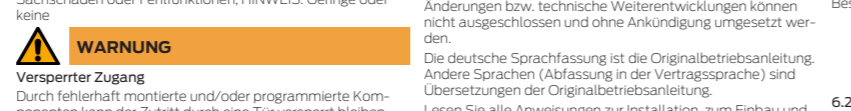

Abb./img. 19

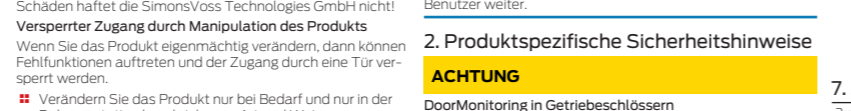

Abb./img. 19

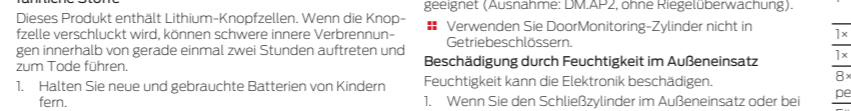

Abb./img. 19

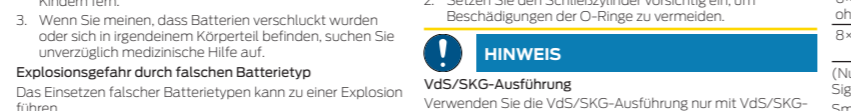

Abb./img. 19

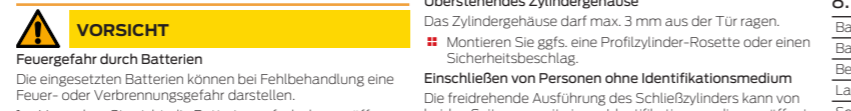

Abb./img. 19

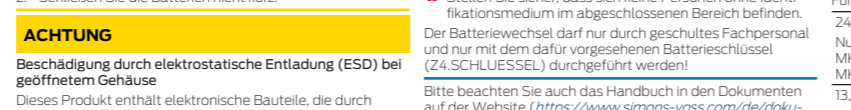

Abb./img. 19

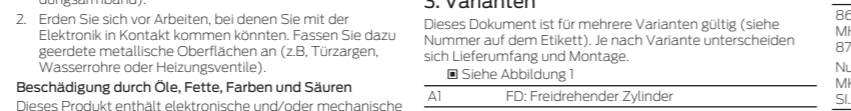

Abb./img. 19



Abb./img. 17

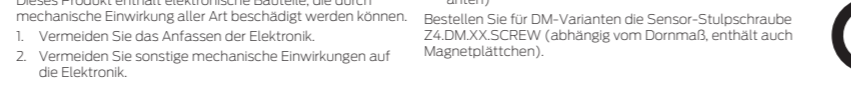

Abb./img. 18

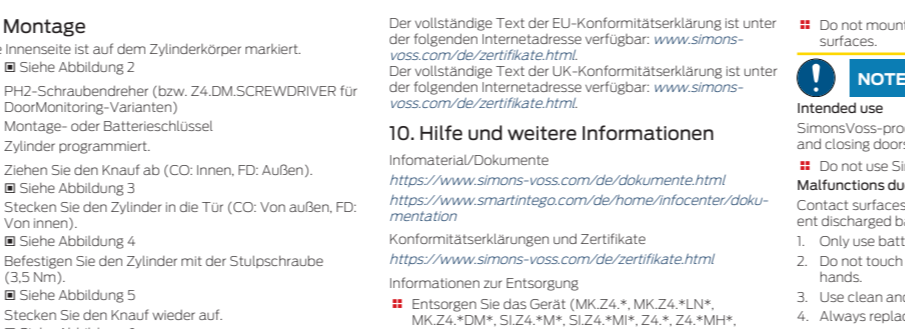

Abb./img. 19

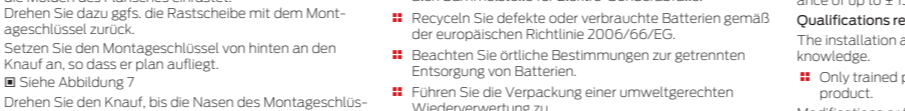

Abb./img. 19

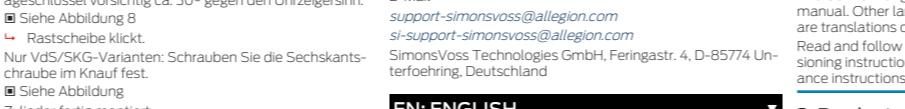

Abb./img. 19

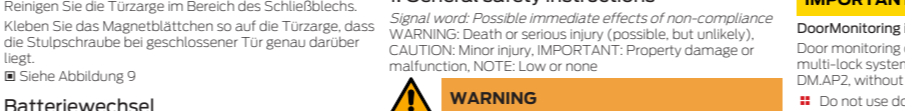

Abb./img. 19

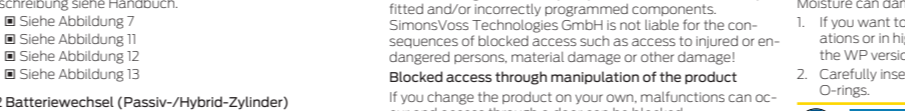

Abb./img. 19

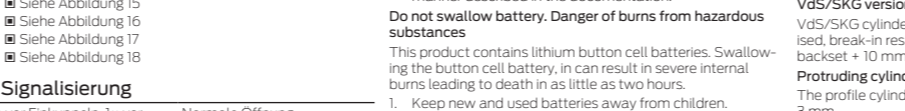

Abb./img. 19

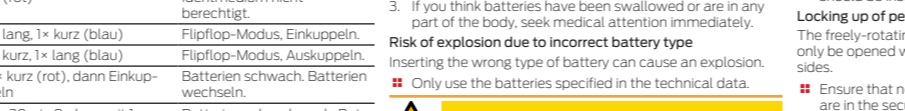

Abb./img. 19

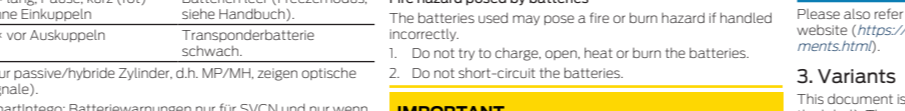

Abb./img. 19

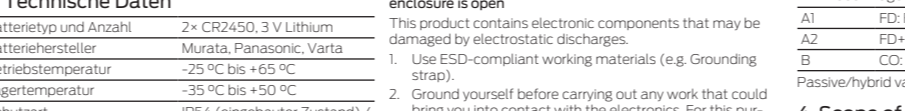

Abb./img. 19

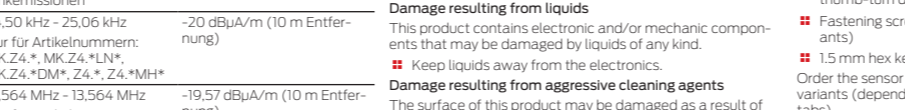

Abb./img. 19

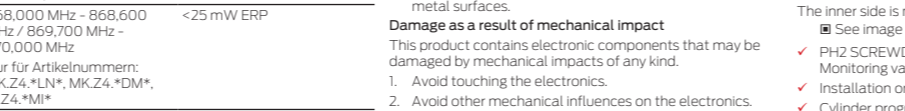

Abb./img. 19

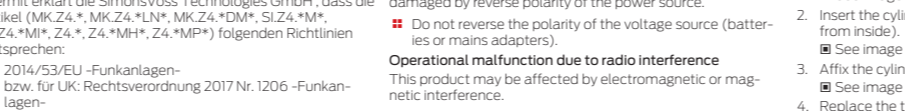

Abb./img. 17

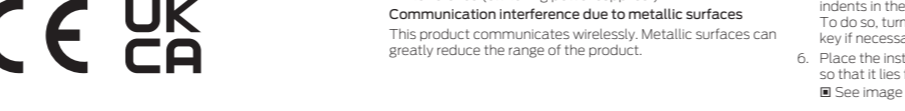

Abb./img. 18

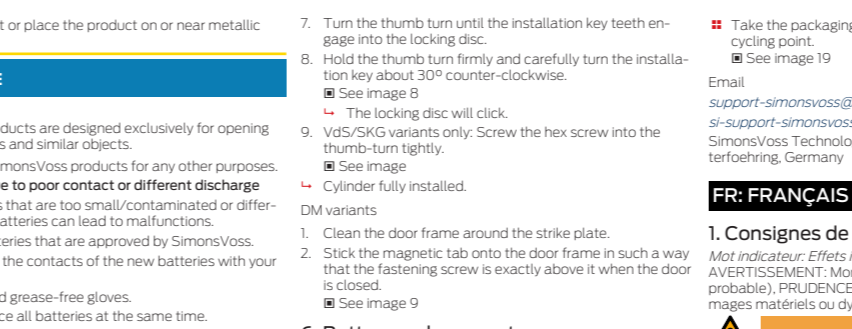

Abb./img. 19

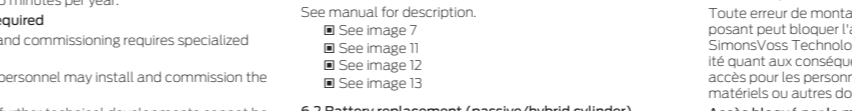

Abb./img. 19

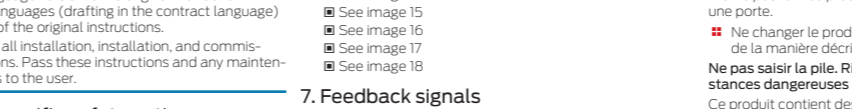

Abb./img. 19

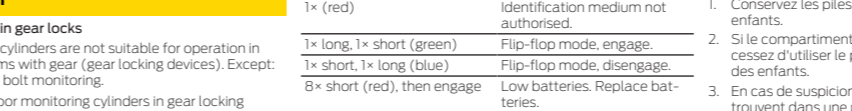

Abb./img. 19

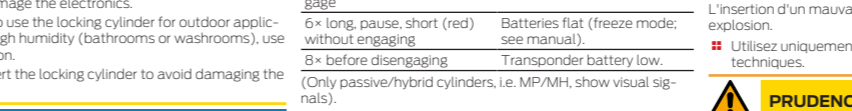

Abb./img. 19

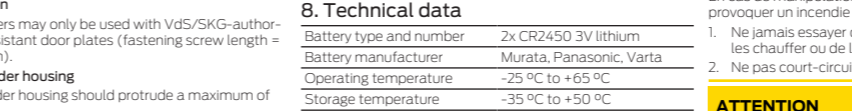

Abb./img. 19

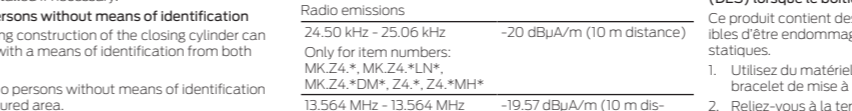

Abb./img. 19

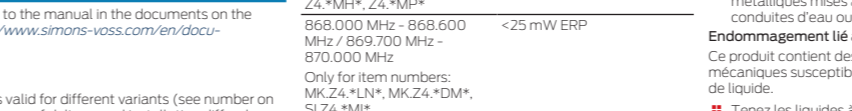

Abb./img. 19

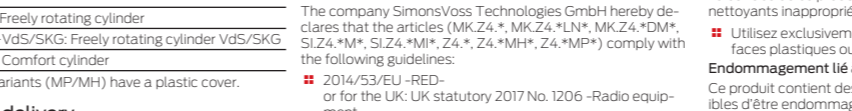

Abb./img. 19



Abb./img. 19

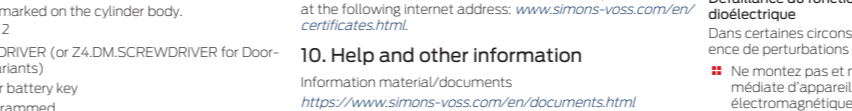

Abb./img. 19

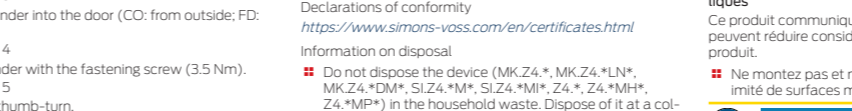

Abb./img. 17

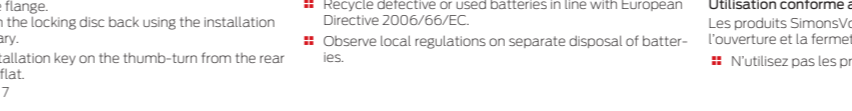

Abb./img. 18

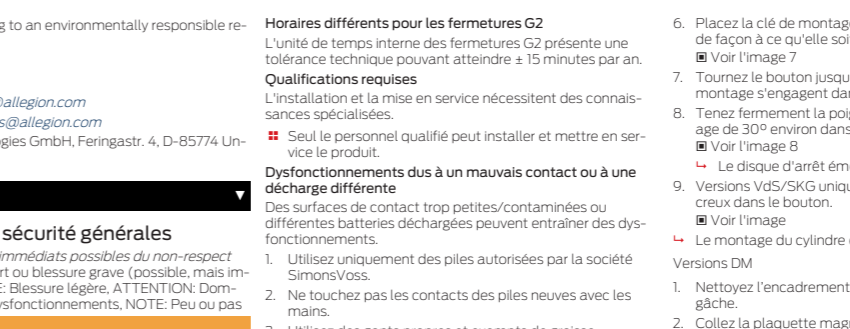

Abb./img. 19

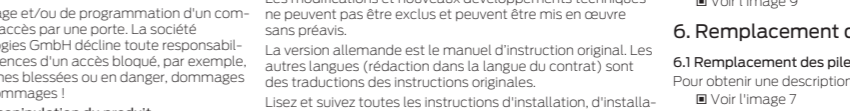

Abb./img. 19

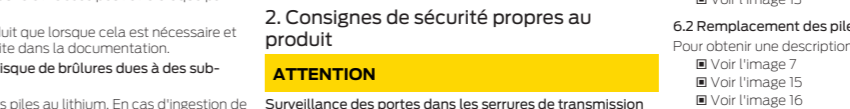

Abb./img. 19

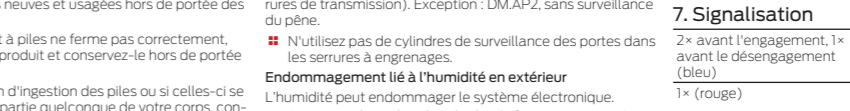

Abb./img. 19

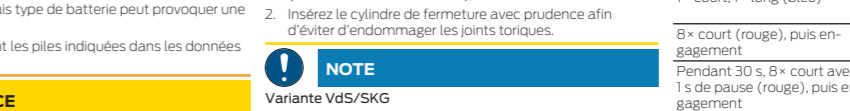

Abb./img. 19

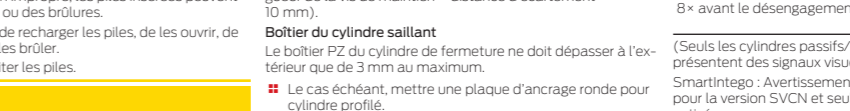

Abb./img. 19

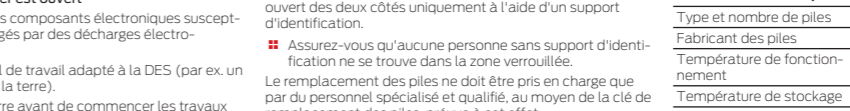

Abb./img. 19

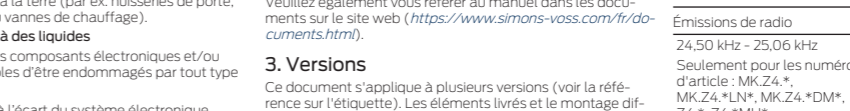

Abb./img. 19

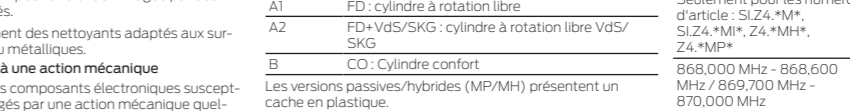

Abb./img. 19

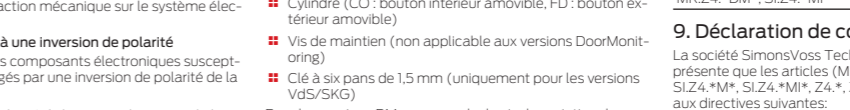

Abb./img. 19

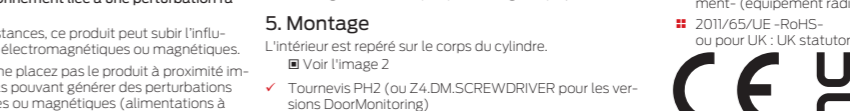

Abb./img. 19

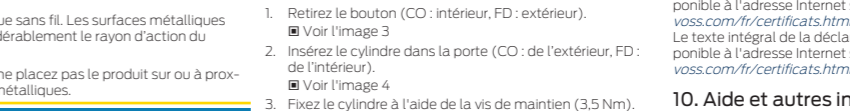

Abb./img. 17

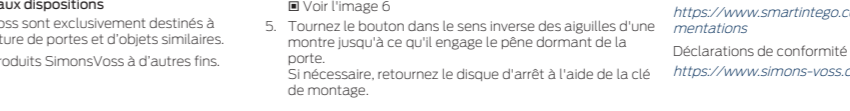

Abb./img. 18

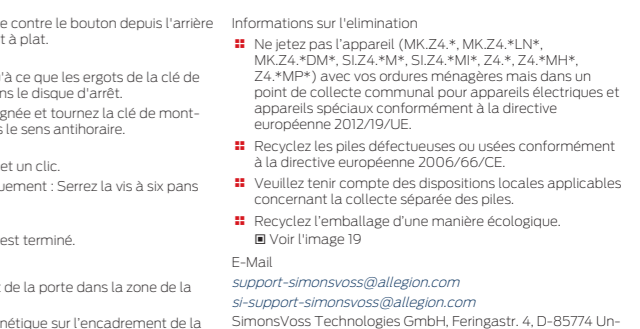

Abb./img. 19



Abb./img. 19



Abb./img. 19



Abb./img. 19

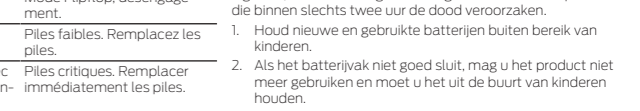

Abb./img. 19



Abb./img. 19



Abb./img. 19



Abb./img. 19



Abb./img. 19



Abb./img. 19



Abb./img. 19

